



SPN3456

N-Channel Enhancement Mode MOSFET

DESCRIPTION

The SPN3456 is the N-Channel logic enhancement mode power field effect transistors are produced using high cell density , DMOS trench technology.

This high density process is especially tailored to minimize on-state resistance.

These devices are particularly suited for low voltage application such as cellular phone and notebook computer power management and other battery powered circuits, and low in-line power loss are needed in a very small outline surface mount package.

FEATURES

- ◆ 30V/6.0A, $R_{DS(ON)} = 40m\Omega @ V_{GS} = 10V$
- ◆ 30V/5.0A, $R_{DS(ON)} = 50m\Omega @ V_{GS} = 4.5V$
- ◆ Super high density cell design for extremely low $R_{DS(ON)}$
- ◆ Exceptional on-resistance and maximum DC current capability
- ◆ TSOP-6P package design

APPLICATIONS

- Power Management in Note book
- Portable Equipment
- Battery Powered System
- DC/DC Converter
- Load Switch
- DSC
- LCD Display inverter

PIN CONFIGURATION(TSOP- 6P)

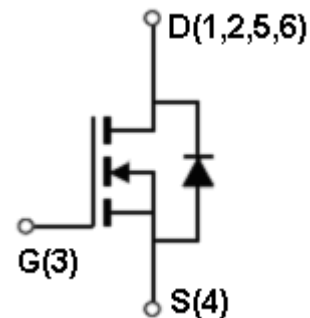
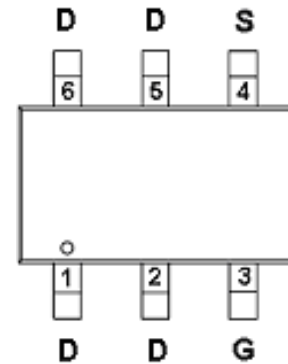

PART MARKING

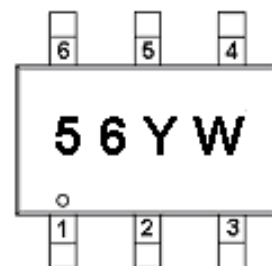

Y : Year Code
W : Week Code



SPN3456

N-Channel Enhancement Mode MOSFET

PIN DESCRIPTION

Pin	Symbol	Description
1	D	Drain
2	D	Drain
3	G	Gate
4	S	Source
5	D	Drain
6	D	Drain

ORDERING INFORMATION

Part Number	Package	Part Marking
SPN3456ST6RG	TSOP-6P	56YW
SPN3456ST6RGB	TSOP-6P	56YW

- ※ Week Code : A ~ Z (1 ~ 26) ; a ~ z (27 ~ 52)
- ※ SPN3456ST6RG : Tape Reel ; Pb – Free
- ※ SPN3456ST6RGB : Tape Reel ; Pb – Free; Halogen – Free
- ※

ABSOLUTE MAXIMUM RATINGS

(TA=25°C Unless otherwise noted)

Parameter	Symbol	Typical	Unit
Drain-Source Voltage	V _{DSS}	30	V
Gate –Source Voltage	V _{GSS}	±20	V
Continuous Drain Current(T _J =150°C)	I _D	TA=25°C	6.0
		TA=70°C	5.0
Pulsed Drain Current	I _{DM}	30	A
Continuous Source Current(Diode Conduction)	I _S	1.7	A
Power Dissipation	P _D	TA=25°C	2.0
		TA=70°C	1.3
Operating Junction Temperature	T _J	150	°C
Storage Temperature Range	T _{STG}	-55/150	°C
Thermal Resistance-Junction to Ambient	R _{θJA}	90	°C/W



SPN3456

N-Channel Enhancement Mode MOSFET

ELECTRICAL CHARACTERISTICS

(TA=25°C Unless otherwise noted)

Parameter	Symbol	Conditions	Min.	Typ	Max.	Unit
Static						
Drain-Source Breakdown Voltage	V _{(BR)DSS}	V _{GS} =0V, I _D =250uA	30			V
Gate Threshold Voltage	V _{GS(th)}	V _{DS} =V _{GS} , I _D =250uA	1.0		3.0	
Gate Leakage Current	I _{GSS}	V _{DS} =0V, V _{GS} =±20V			±100	nA
Zero Gate Voltage Drain Current	I _{DSS}	V _{DS} =24V, V _{GS} =1.0V			1	uA
		V _{DS} =24V, V _{GS} =0.0V T _J =55°C			10	
On-State Drain Current	I _{D(on)}	V _{DS} ≥ 4.5V, V _{GS} =4.5V	10			A
Drain-Source On-Resistance	R _{DS(on)}	V _{GS} = 10V, I _D =6.0A		0.030	0.040	Ω
		V _{GS} = 4.5V, I _D =5.0A		0.040	0.050	
Forward Transconductance	g _{fs}	V _{DS} =4.5V, I _D =5.4A		12		S
Diode Forward Voltage	V _{SD}	I _S =1.7A, V _{GS} =0V		0.8	1.2	V
Dynamic						
Total Gate Charge	Q _g	V _{DS} =15V, V _{GS} =10V I _D =6.7A		10	18	nC
Gate-Source Charge	Q _{gs}			1.6		
Gate-Drain Charge	Q _{gd}			3.2		
Input Capacitance	C _{iss}	V _{DS} =15V, V _{GS} =0V f=1MHz		450		pF
Output Capacitance	C _{oss}			240		
Reverse Transfer Capacitance	C _{rss}			38		
Turn-On Time	t _{d(on)}	V _{DD} =15V, R _L =15Ω I _D =1.0A, V _{GEN} =10V R _G =6Ω		7	15	ns
	t _r			10	20	
Turn-Off Time	t _{d(off)}			20	40	
	t _f			11	20	



SPN3456

N-Channel Enhancement Mode MOSFET

TYPICAL CHARACTERISTICS

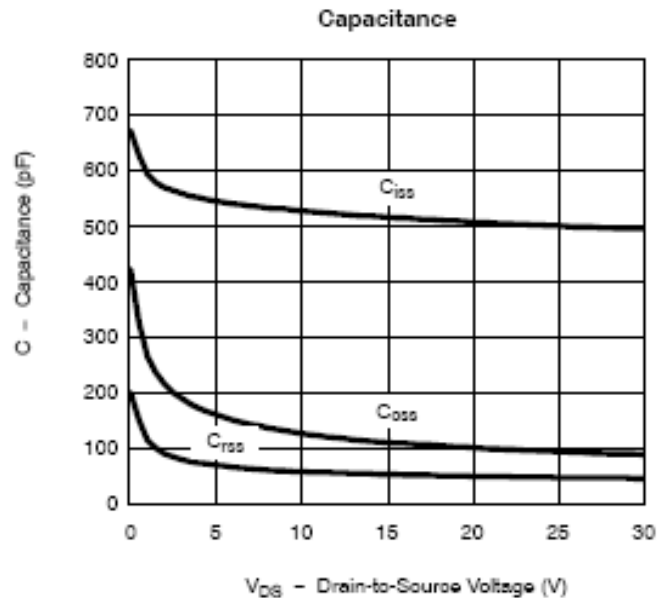
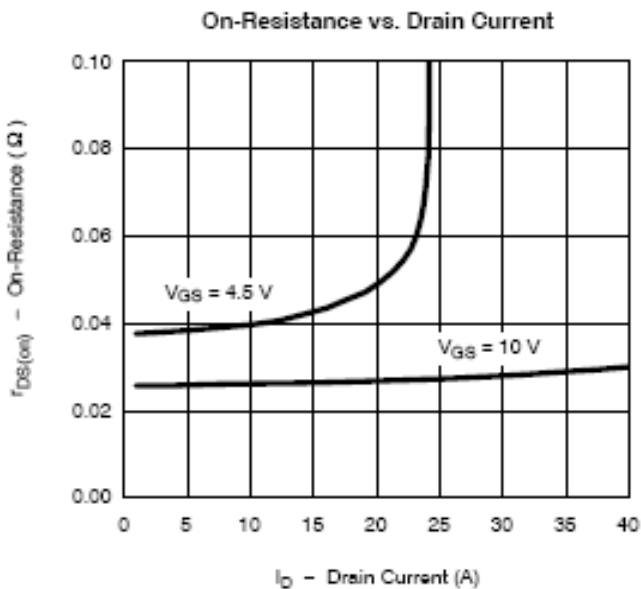
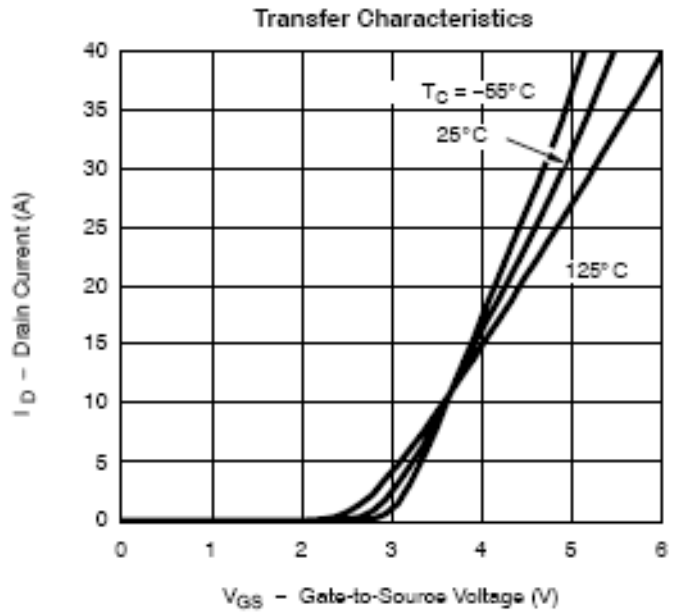
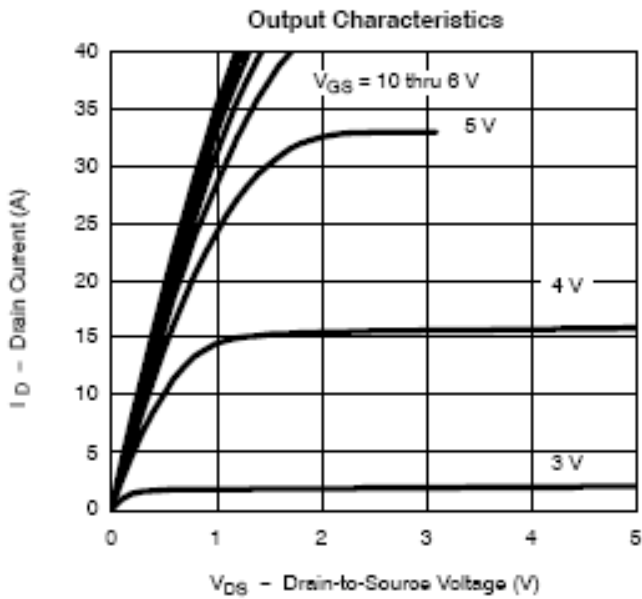



SPN3456

N-Channel Enhancement Mode MOSFET

TYPICAL CHARACTERISTICS

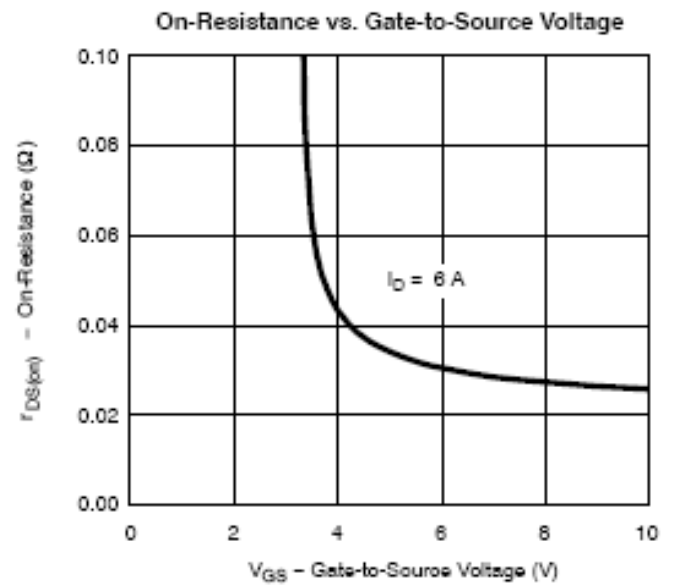
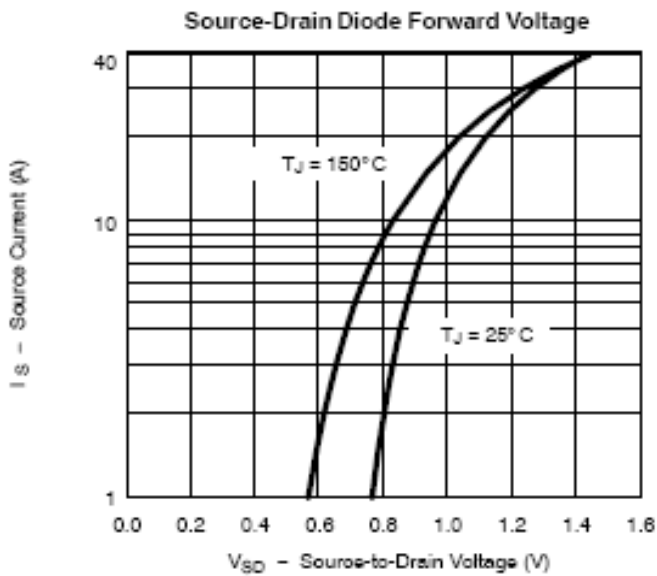
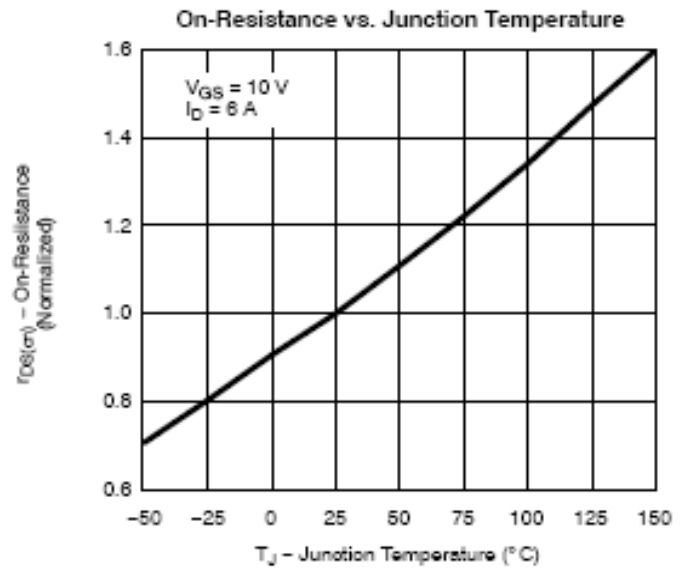
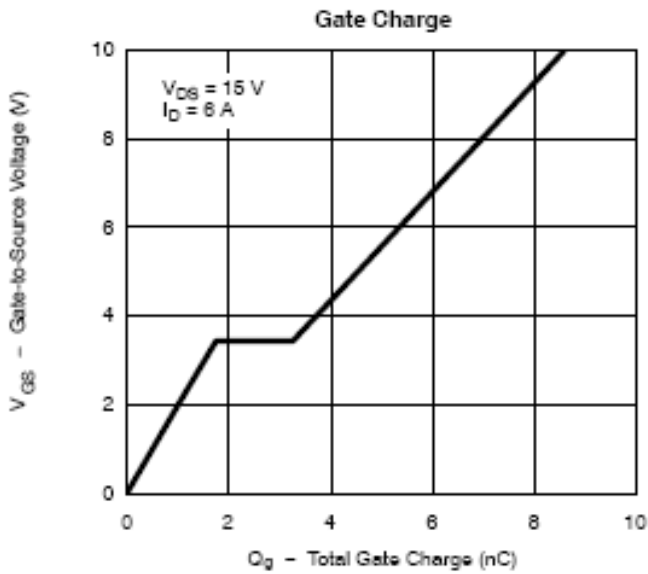



SPN3456 N-Channel Enhancement Mode MOSFET

TYPICAL CHARACTERISTICS

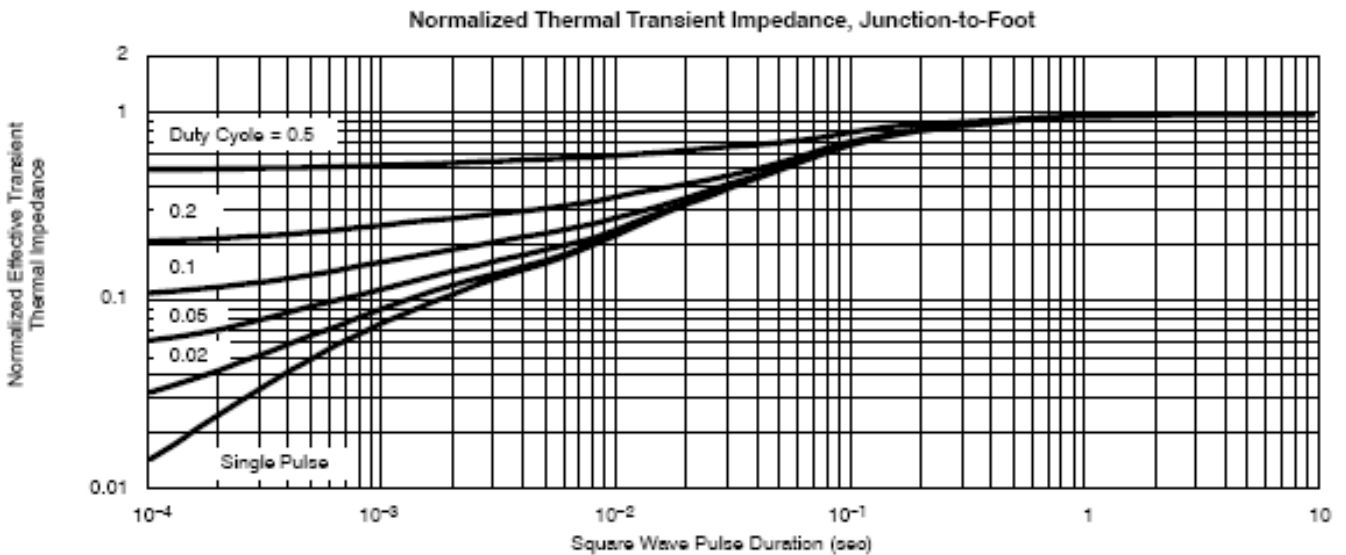
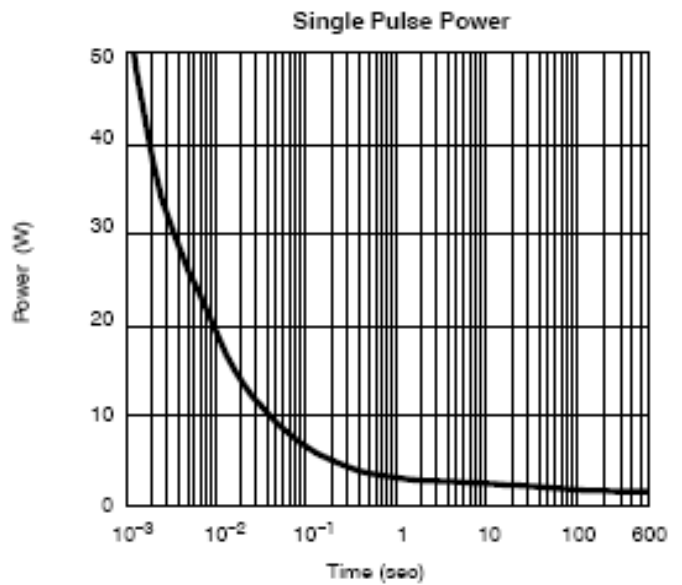
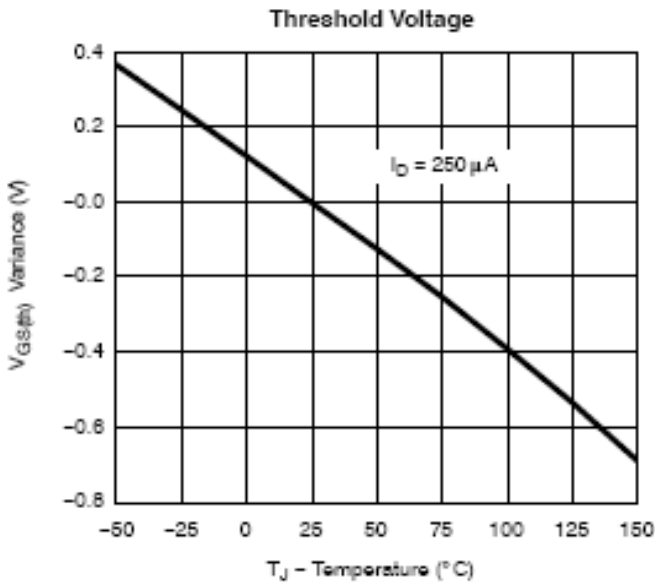



SPN3456

N-Channel Enhancement Mode MOSFET

TSOP- 6P PACKAGE OUTLINE

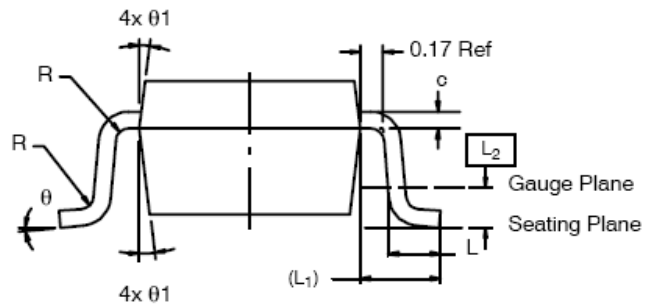
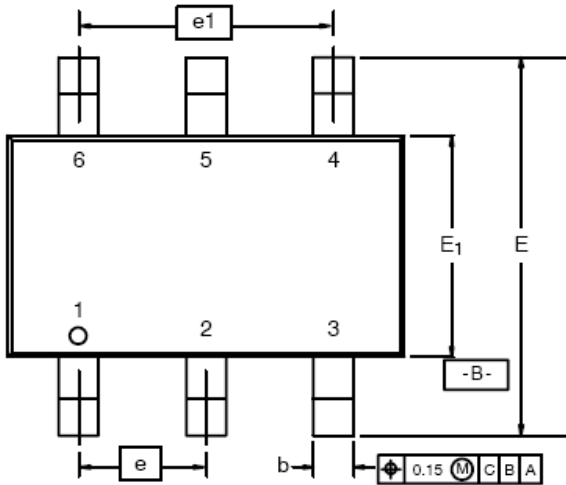

Dim	MILLIMETERS			INCHES		
	Min	Nom	Max	Min	Nom	Max
A	0.91	-	1.10	0.036	-	0.043
A₁	0.01	-	0.10	0.0004	-	0.004
A₂	0.90	-	1.00	0.035	0.038	0.039
b	0.30	0.32	0.45	0.012	0.013	0.018
c	0.10	0.15	0.20	0.004	0.006	0.008
D	2.95	3.05	3.10	0.116	0.120	0.122
E	2.70	2.85	2.98	0.106	0.112	0.117
E₁	1.55	1.65	1.70	0.061	0.065	0.067
e	1.00 BSC			0.0394 BSC		
e₁	1.90	2.00	2.10	0.075	0.080	0.085
L	0.35	-	0.50	0.014	-	0.020
L₁	0.60 Ref			0.024 Ref		
L₂	0.25 BSC			0.010 BSC		
R	0.10	-	-	0.004	-	-
θ	0°	4°	8°	0°	4°	8°
θ₁	7° Nom			7° Nom		



SPN3456

N-Channel Enhancement Mode MOSFET

Information provided is alleged to be exact and consistent. SYNC Power Corporation presumes no responsibility for the penalties of use of such information or for any violation of patents or other rights of third parties which may result from its use. No license is granted by allegation or otherwise under any patent or patent rights of SYNC Power Corporation. Conditions mentioned in this publication are subject to change without notice. This publication surpasses and replaces all information previously supplied. SYNC Power Corporation products are not authorized for use as critical components in life support devices or systems without express written approval of SYNC Power Corporation.

©The SYNC Power logo is a registered trademark of SYNC Power Corporation

©2004 SYNC Power Corporation – Printed in Taiwan – All Rights Reserved

SYNC Power Corporation

7F-2, No.3-1, Park Street

NanKang District (NKSP), Taipei, Taiwan, 115, R.O.C

Phone: 886-2-2655-8178

Fax: 886-2-2655-8468

©<http://www.syncpower.com>