

MA100RU Series

Wide 4:1 Input, 1.5W, Single & Dual Output DC/DC Converters



Key Features:

- 1.5W Output Power
- 4:1 Input Voltage Range
- 1,500 VDC Isolation
- 20 Standard Models
- High Efficiency
- Compact DIP Case
- -40°C to +85°C Operation
- Metal Case Available
- Low Cost

Alternate Pin-Out Available

1.5 kV Isolation Models Available

RoHS



MicroPower Direct

292 Page Street
Suite D
Stoughton, MA 02072
USA

T: (781) 344-8226

F: (781) 344-8481

E: sales@micropowerdirect.com

W: www.micropowerdirect.com



Electrical Specifications

Specifications typical @ +25°C, nominal input voltage & rated output current, unless otherwise noted. Specifications subject to change without notice.

Input

Parameter	Conditions	Min.	Typ.	Max.	Units
Input Voltage Range	24 VDC Input	9.0	24.0	36.0	VDC
	48 VDC Input	18.0	48.0	72.0	
Input Reflected Ripple Current			35		mA P - P
Input Filter	π (Pi) Filter				

Output

Parameter	Conditions	Min.	Typ.	Max.	Units
Output Voltage Accuracy			±1.0		%
Line Regulation	V _{IN} = Min to Max		±0.5		%
Load Regulation	I _{OUT} = 25% to 100%		±0.5		%
Cross Regulation	See Note 1		±0.5		%
Ripple & Noise (20 MHz)	See Note 2		60		mV P - P
Temperature Coefficient			±0.02		%/°C
Output Short Circuit	Continuous (Autorecovery)				

General

Parameter	Conditions	Min.	Typ.	Max.	Units
Isolation Voltage, See Note 3	3 Seconds	1,500			VDC
Isolation Resistance	500 VDC	1,000			MΩ
Isolation Capacitance	100 kHz/0.1V		60		pF
Switching Frequency		100		400	kHz

Environmental

Parameter	Conditions	Min.	Typ.	Max.	Units
Operating Temperature Range	Ambient	-40	+25	+85	°C
Operating Temperature Range	Case			+100	°C
Storage Temperature Range		-40		+125	°C
Cooling	Free Air Convection				
Humidity	RH, Non-condensing			95	%

Physical

Case Size	1.25 x 0.80 x 0.40 Inches (31.75 x 20.32 x 10.16 mm)				
Case Material, Plastic	Non-Conductive Black Plastic (UL94-V0)				
Weight, Plastic Case	0.44 Oz (12.5g)				
Case Material, Metal	Nickel-Coated Copper With Non-Conductive Base (UL94-V0)				
Weight, Metal Case	0.53 Oz (15g)				

Reliability Specifications

Parameter	Conditions	Min.	Typ.	Max.	Units
MTBF	MIL HDBK 217F, 25°C, Gnd Benign	1.0			MHours

Absolute Maximum Ratings

Parameter	Conditions	Min.	Typ.	Max.	Units
Input Voltage Surge (1 Sec)	24 VDC Input	-0.7		40.0	VDC
	48 VDC Input	-0.7		80.0	
Lead Temperature	1.5 mm From Case for 10 Sec			260	°C

Caution: Exceeding Absolute Maximum Ratings may damage the module. These are not continuous operating ratings.

www.micropowerdirect.com

Model Number	Input				Output			Efficiency (% Typ)	Reflected Ripple Current (mA Typ)	Capacitive Load (µF Max)	Fuse Rating Slow-Blow (mA)
	Voltage (VDC)		Current (mA)		Voltage (VDC)	Current (mA, Max)	Current (mA, Min)				
	Nominal	Range	Full-Load	No-Load							
MA124S-05RU-xx	24	9.0 - 36.0	91.0	20	5.0	300.0	100.0	68	35.0	2,200	200
MA124S-09RU-xx	24	9.0 - 36.0	89.0	20	9.0	167.0	55.7	70	35.0	470	200
MA124S-12RU-xx	24	9.0 - 36.0	86.0	20	12.0	125.0	41.7	72	35.0	470	200
MA124S-15RU-xx	24	9.0 - 36.0	86.0	20	15.0	100.0	33.3	72	35.0	470	200
MA124S-24RU-xx	24	9.0 - 36.0	88.0	30	24.0	62.5	20.8	71	35.0	220	200
MA124D-05RU-xx	24	9.0 - 36.0	94.0	20	±5.0	±150.0	±50.0	66	35.0	±1,000	200
MA124D-09RU-xx	24	9.0 - 36.0	91.0	20	±9.0	±83.3	±27.8	68	35.0	±220	200
MA124D-12RU-xx	24	9.0 - 36.0	89.0	20	±12.0	±62.5	±20.8	70	35.0	±220	200
MA124D-15RU-xx	24	9.0 - 36.0	89.0	20	±15.0	±50.0	±16.7	70	35.0	±220	200
MA124D-24RU-xx	24	9.0 - 36.0	90.0	30	±24.0	±31.0	±10.3	69	35.0	±100	200
MA148S-05RU-xx	48	18.0 - 72.0	44.0	10	5.0	300.0	100.0	70	35.0	2,200	100
MA148S-09RU-xx	48	18.0 - 72.0	43.0	10	9.0	167.0	55.7	72	35.0	470	100
MA148S-12RU-xx	48	18.0 - 72.0	42.0	10	12.0	125.0	41.7	74	35.0	470	100
MA148S-15RU-xx	48	18.0 - 72.0	42.0	10	15.0	100.0	33.3	74	35.0	470	100
MA148S-24RU-xx	48	18.0 - 72.0	43.0	10	24.0	62.5	20.8	72	35.0	220	100
MA148D-05RU-xx	48	18.0 - 72.0	45.0	10	±5.0	±150.0	±50.0	68	35.0	±1,000	100
MA148D-09RU-xx	48	18.0 - 72.0	44.0	10	±9.0	±83.3	±27.8	70	35.0	±220	100
MA148D-12RU-xx	48	18.0 - 72.0	43.0	10	±12.0	±62.5	±20.8	72	35.0	±220	100
MA148D-15RU-xx	48	18.0 - 72.0	43.0	10	±15.0	±50.0	±16.7	72	35.0	±220	100
MA148D-24RU-xx	48	18.0 - 72.0	44.0	10	±24.0	±31.0	±10.3	71	35.0	±100	100

For the alternate pin-out (see page 4) , add suffix "P2" to model number (i.e. MA124S-05RU-P2)

- Notes:
1. Cross regulation is measured with the output being tested at 100% load while the other output is varied from 25% to 100% load.
 2. See the typical connection circuit on page three for typical external filtering components. For help with a specific model or layout issue, contact the factory.
 3. Isolation voltage is specified for Input to output. On units with the optional metal case, the isolation voltage for Input - Case and Output - Case is 1,000 VDC.
 4. Operation at no-load will not damage the unit, but they may not meet all specifications. To meet all specifications, a minimum load of 33% should be maintained.
 5. It is recommended that a fuse be used on the input of a power supply for protection. See the Model Selection table above for the correct rating.

NEW DIP DC/DC Converter Families From MPD

Series	Power	Input Range	Isolation
MA100X-xxRW	1W	2:1	1.5 kVDC
MA100X-xxRWI	1W	2:1	3.5 kVDC
MA100X-xxRU	1W	4:1	1.5 kVDC
MA100X-xxRUI	1W	4:1	3.5 kVDC
MA200X-xxRW	2W	2:1	1.5 kVDC
MA200X-xxRWI	2W	2:1	3.5 kVDC
MA200X-xxRU	2W	4:1	1.5 kVDC
MA200X-xxRUI	2W	4:1	3.5 kVDC
MA300X-xxRW	3W	2:1	1.5 kVDC
MA300X-xxRWI	3W	2:1	3.0 kVDC
MA300X-xxRU	3W	4:1	1.5 kVDC
MA300X-xxRUI	3W	4:1	3.0 kVDC
MA400X-xxRW	4W	2:1	1.5 kVDC
MA400X-xxRWI	4W	2:1	3.5 kVDC
MA400X-xxRU	4W	4:1	1.5 kVDC
MA400X-xxRUI	4W	4:1	3.5 kVDC
MA500X-xxRW	5W	2:1	1.5 kVDC
MA500X-xxRWI	5W	2:1	3.5 kVDC
MA500X-xxRU	5W	4:1	1.5 kVDC
MA500X-xxRUI	5W	4:1	3.5 kVDC
MA600X-xxRW	6W	2:1	1.5 kVDC
MA600X-xxRWI	6W	2:1	3.0 kVDC
MA600X-xxRU	6W	4:1	1.5 kVDC
MA600X-xxRUI	6W	4:1	3.0 kVDC

Model Number

MA-1XXX-XXRXMI

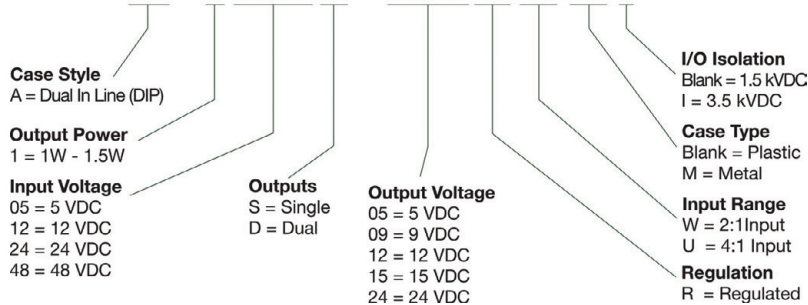

Visit our website or contact the factory for more information.

Typical Connection

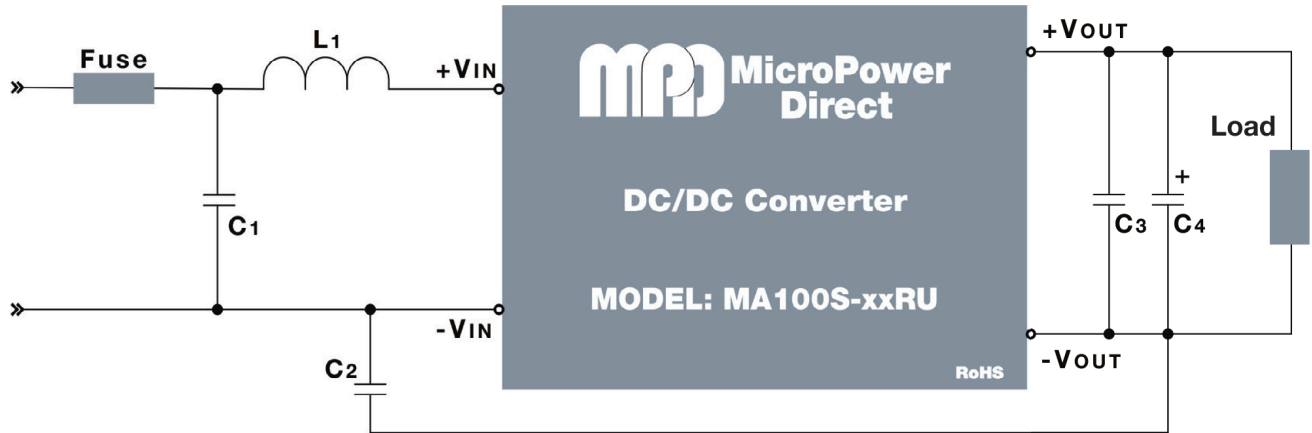

The diagram above illustrates a typical connection of the **MA100RU** series for applications that require meeting conducted EMC standards. The units do not require external components to operate as specified. For applications requiring very low output noise levels, the output filtering capacitors (C3 is a low ESR electrolytic & C4 is a ceramic) will often be sufficient. Care must be taken in choosing output capacitors not to exceed the capacitive load specification for the unit. For dual output units, output capacitors should be connected from each output to common. All external components should be mounted as close to the unit as possible.

The recommended values for components are:

Component	24 V _{IN}	48 V _{IN}
C1	220 μ F/100V	220 μ F/100V
LCM	12 μ H	12 μ H
C2	470 pF/4kV MLCC	470 pF/4kV MLCC
C3	100 μ F	100 μ F
C4	4.7 - 10 μ F	4.7 - 10 μ F

Typical Board Layout: With External Filter Components, Single Output

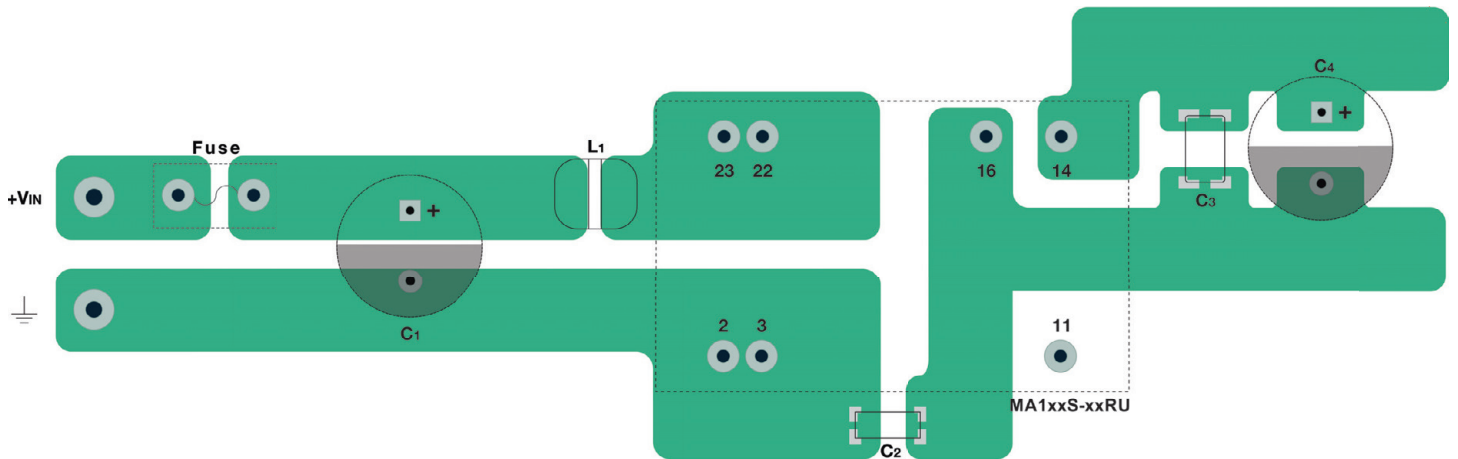

Typical Board Layout: With External Filter Components, Dual Output

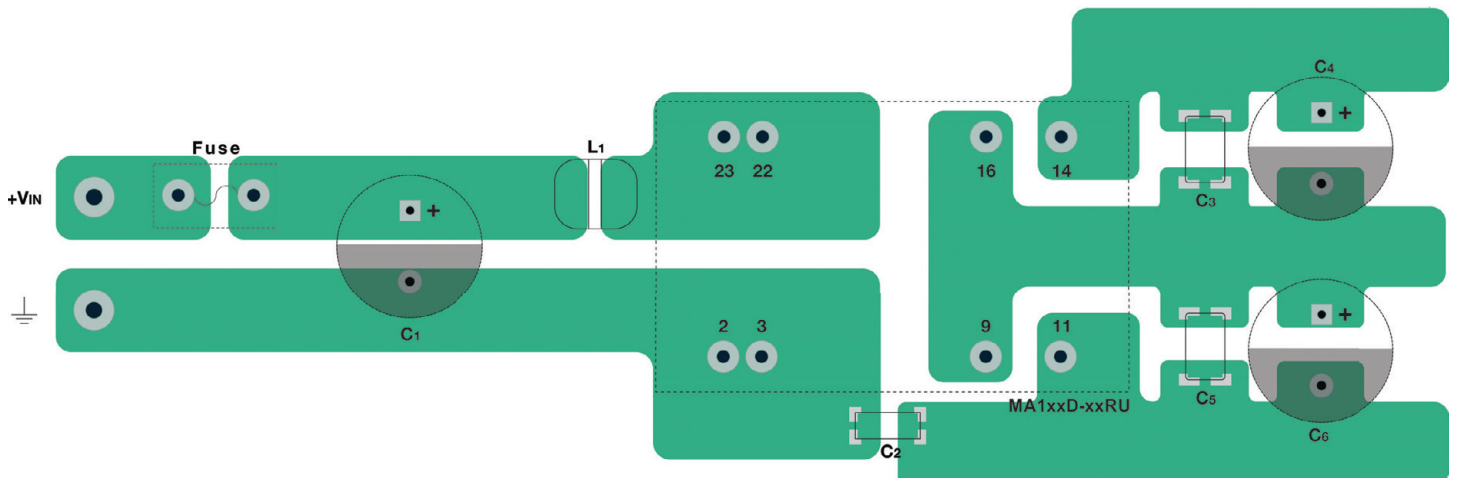

Input noise and surge suppression modules are available for a number of MPD DC/DC power supplies. Contact the factory for more information.

Standard Units - Plastic Case

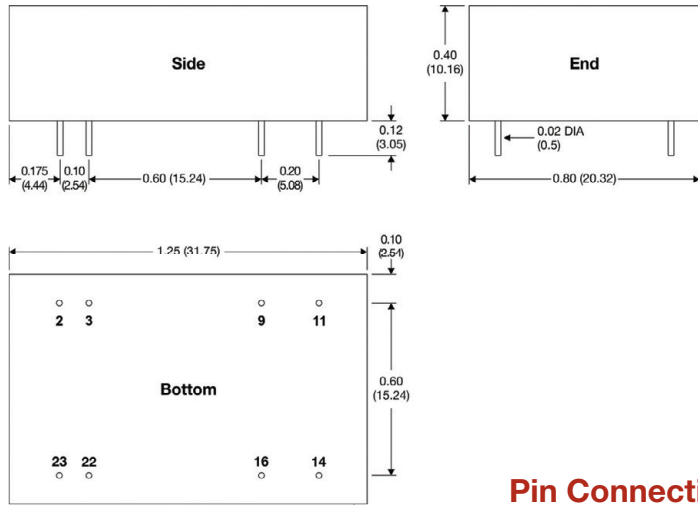

Standard Units - Metal Case

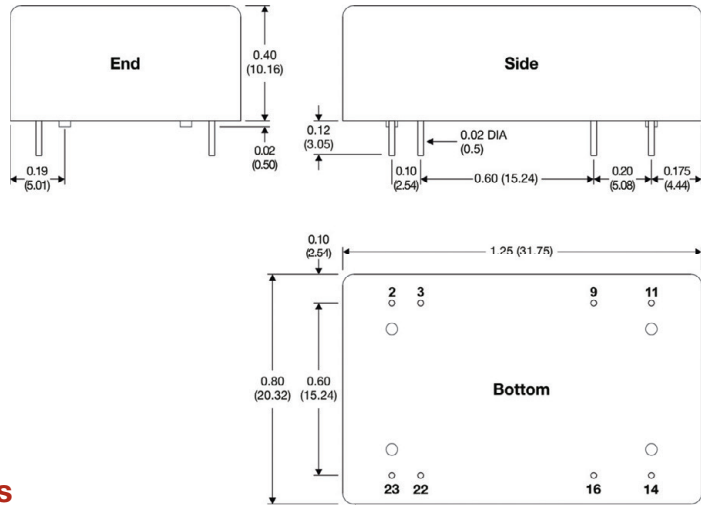

Pin Connections

Pin	Single Output	Pin	Dual Output
2	-VIN	2	-VIN
3	-VIN	3	-VIN
9	No Pin	9	Common
11	No Connection	11	-VOUT
14	+VOUT	14	+VOUT
16	-VOUT	16	Common
22	+VIN	22	+VIN
23	+VIN	23	+VIN

For the alternate pin-out, add suffix "P2" to model number (i.e. MA124S-05RU-P2)

Alternate Pin-Out Units - Plastic Case

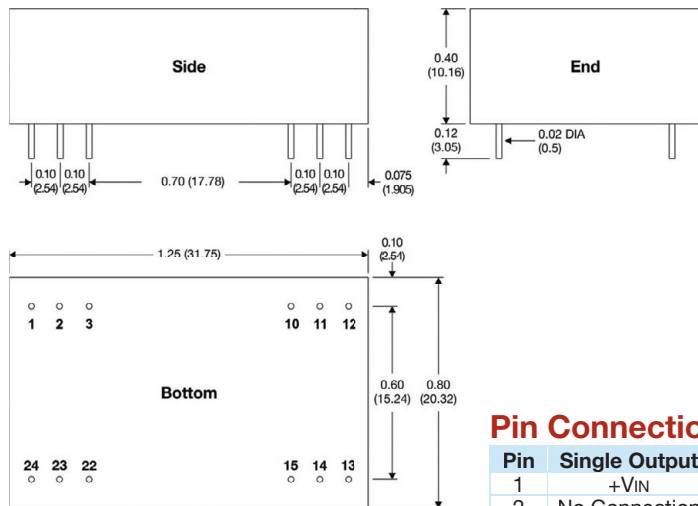

Alternate Pin-Out Units - Metal Case

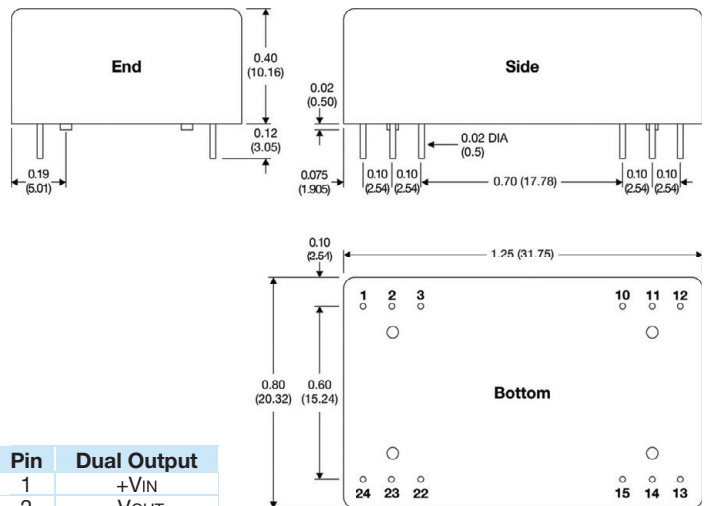

Pin Connections

Pin	Single Output	Pin	Dual Output
1	+VIN	1	+VIN
2	No Connection	2	-VOUT
3	No Connection	3	Common
10	-VOUT	10	Common
11	+VOUT	11	+VOUT
12	-VIN	12	-VIN
13	-VIN	13	-VIN
14	+VOUT	14	+VOUT
15	-VOUT	15	Common
22	No Connection	22	Common
23	No Connection	23	-VOUT
24	+VIN	24	+VIN

Notes:

- All dimensions are typical in inches (mm)
- Tolerance x.xx = ±0.02 (±0.50)
- Pin 1 is marked by a "dot" or indentation on the top of the unit



MicroPower Direct
We Power Your Success - For Less!