

J-FET INPUT DUAL OP-AMPS

- LOW POWER CONSUMPTION
- WIDE COMMON-MODE AND DIFFERENTIAL VOLTAGE RANGE
- LOW INPUT BIAS AND OFFSET CURRENT
- OUTPUT SHORT-CIRCUIT PROTECTION
- HIGH INPUT IMPEDANCE J-FET INPUT STAGE
- INTERNAL FREQUENCY COMPENSATION
- LATCH UP FREE OPERATION
- HIGH SLEW RATE : 13 V/ μ s (typ)

DESCRIPTION

The LF353 - 353A - 353B are high speed J-FET input dual operational amplifiers incorporating well matched, high voltage J-FET and bipolar transistors in a monolithic integrated circuit.

The devices feature high slew rates, low input bias and offset currents, and low offset voltage temperature coefficient.

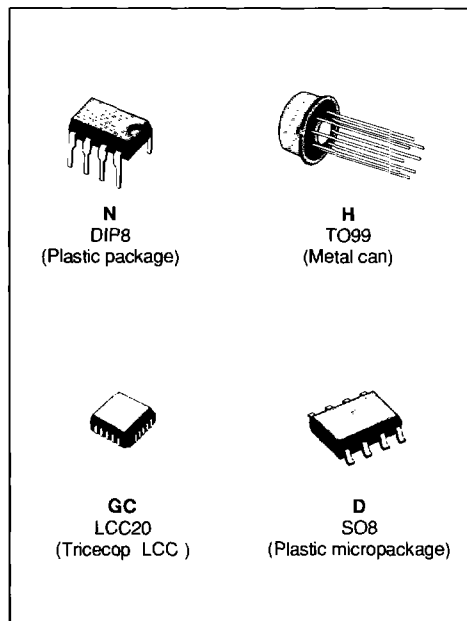

PIN CONNECTIONS (Top views)

**DIP8
SO8**

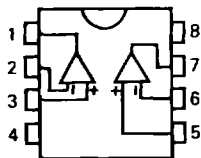

- 1 - Output 1
- 2 - Inverting input 1
- 3 - Non-inverting input 1
- 4 - V_{CC}
- 5 - Non-inverting input 2
- 6 - Inverting input 2
- 7 - Output 2
- 8 - V_{CC}

TO99

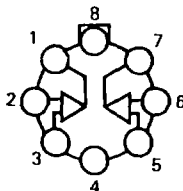

- 1 - NC
- 2 - Output 1
- 3 - NC
- 4 - NC
- 5 - Inverting input 1
- 6 - NC
- 7 - Non-inverting input 1
- 8 - NC
- 9 - NC
- 10 - V_{CC}
- 11 - NC
- 12 - Non-inverting input 2
- 13 - NC
- 14 - NC
- 15 - Inverting input 2
- 16 - NC
- 17 - Output 2
- 18 - NC
- 19 - NC
- 20 - V_{CC}

LCC20

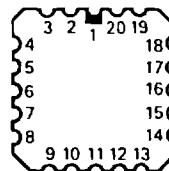

ORDER CODES

Part Number	Temperature	Package
LF153GC	- 55 °C to + 125 °C	LCC
LF153AGC	- 55 °C to + 125 °C	LCC
LF153BGC	- 55 °C to + 125 °C	LCC
LF153H	- 55 °C to + 125 °C	METAL CAN
LF153AH	- 55 °C to + 125 °C	METAL CAN
LF153BH	- 55 °C to + 125 °C	METAL CAN
LF253N	- 40 °C to + 105 °C	DIP8
LF253AN	- 40 °C to + 105 °C	DIP8
LF253BN	- 40 °C to + 105 °C	DIP8
LF253D	- 40 °C to + 105 °C	SO8
LF253AD	- 40 °C to + 105 °C	SO8
LF253BD	- 40 °C to + 105 °C	SO8
LF353N	0 °C to + 70 °C	DIP8
LF353AN	0 °C to + 70 °C	DIP8
LF353BN	0 °C to + 70 °C	DIP8
LF353D	0 °C to + 70 °C	SO8
LF353AD	0 °C to + 70 °C	SO8
LF353BD	0 °C to + 70 °C	SO8

ABSOLUTE MAXIMUM RATINGS

Symbol	Parameter	Value	Unit
V _{CC}	Supply Voltage (note 1)	± 18	V
V _i	Input Voltage (note 3)	± 15	V
V _{CC}	Diff. Input Voltage (note 2)	± 30	V
P _{tot}	Power Dissipation	680	mW
	Output Short-circuit Duration (note 4)	Infinite	
T _{oper}	Operating Free Air Temperature Range		°C
	LF353, A, B	0 to 70	
	LF253, A, B	- 40 to 105	
	LF153, A, B	- 55 to 125	
T _{stg}	Storage Temperature Range	- 65 to 150	°C

- Notes :**
1. All voltage values, except differential voltage, are with respect to the zero reference level (ground) of the supply voltages where the zero reference level is the midpoint between V_{CC} and V_{CC}.
 2. Differential voltages are at the non-inverting input terminal with respect to the inverting input terminal.
 3. The magnitude of the input voltage must never exceed the magnitude of the supply voltage or 15 volts, whichever is less.
 4. The output may be shorted to ground or to either supply. Temperature and /or supply voltages must be limited to ensure that the dissipation rating is not exceeded.

SCHEMATIC DIAGRAM

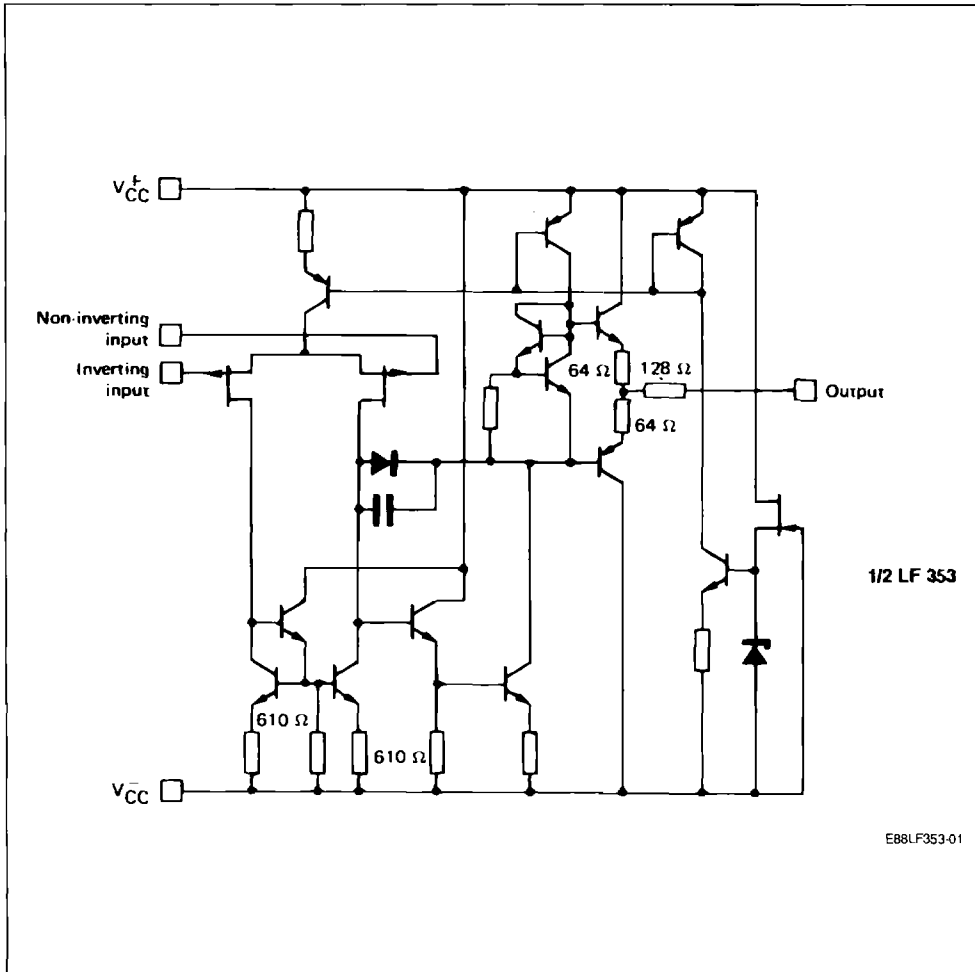

Case	Outputs	Non-inverting Inputs	Inverting Inputs	V _{CC}	V _{CC}	N.C.
DIP8 SO8 TO99	1, 7	3, 5	2, 6	4	8	
LCC20	2, 17	7, 12	5, 15	10	20	*

* LCC20 : Other pins are not connected.

ELECTRICAL CHARACTERISTICS

V_{cc} = ± 15 V (unless otherwise specified)

LF153, LF153A, LF153B - 55 ≤ T_{amb} ≤ + 125 °C

LF253, LF153A, LF253B - 40 ≤ T_{amb} ≤ + 105 °C

LF353, LF153A, LF353B 0 ≤ T_{amb} ≤ + 70 °C

Symbol	Parameter	LF153A, B LF253A, B LF353A, B			LF153 LF253 LF353			Unit
		Min.	Typ.	Max.	Min.	Typ.	Max.	
V _{io}	Input Offset Voltage T _{amb} = 25 °C (R _s < 10 kΩ) LF153B, LF253B, LF353B LF153A, LF253A, LF353A T _{min} ≤ T _{amb} ≤ T _{max} LF153B, LF253B, LF353B LF153A, LF253A, LF353A	3 1	5 2			3	8	mV
DV _{io}	Input Offset Voltage Drift		10			10		μV/°C
I _{io}	Input Offset Current * T _{amb} = 25 °C T _{min} ≤ T _{amb} ≤ T _{max}		5	50 4		5	50 4	pA nA
I _{ib}	Input Bias Current * T _{amb} = 25 °C T _{min} ≤ T _{amb} ≤ T _{max}		20	200 20		20	200 20	pA nA
A _{vd}	Large Signal Voltage Gain (R _L > 2 kΩ, V _o = ± 10 V) T _{amb} = 25 °C T _{min} ≤ T _{amb} ≤ T _{max}	50 25	200		50 25	200		V/mV
SVR	Supply voltage Rejection Ratio (R _s < 10 kΩ) T _{amb} = 25 °C T _{min} ≤ T _{amb} ≤ T _{max}	80 80	86		80 80	86		dB
I _{cc}	Supply Current, per Amp, no Load T _{amb} = 25 °C T _{min} ≤ T _{amb} ≤ T _{max}		1.4	2.5 2.5		1.4	2.5 2.5	mA
V _i	Input Voltage Range T _{amb} = 25 °C T _{min} ≤ T _{amb} ≤ T _{max}	- 11		+ 11	- 11		+ 11	V
CMR	Common Mode Rejection Ratio (R _s < 10 kΩ) T _{amb} = 25 °C T _{min} ≤ T _{amb} ≤ T _{max}	80 80	86		70 70	86		dB
I _{os}	Output Short-circuit Current T _{amb} = 25 °C T _{min} ≤ T _{amb} ≤ T _{max}	10 10	40	60 60	10 10	40	60 60	mA
± V _{opp}	Output Voltage Swing T _{amb} = 25 °C R _L ≥ 2 kΩ R _L ≥ 10 kΩ T _{min} ≤ T _{amb} ≤ T _{max} R _L ≥ 2 kΩ R _L ≥ 10 kΩ	11 12 11 12	12 13.5		11 12 11 12	12 13.5		V
S _{vo}	Slew-rate (V _i = 10 V, R _L = 2 kΩ) C _L ≤ 100 pF, T _{amb} = 25 °C, unity gain)	12	16		12	16		V/μs

ELECTRICAL CHARACTERISTICS (continued)

Symbol	Parameter	LF153A, B LF253A, B LF353A, B			LF153 LF253 LF353			Unit
		Min.	Typ.	Max.	Min.	Typ.	Max.	
t_r	Rise Time ($V_i = 20$ mV, $R_L = 2$ k Ω) $C_L = 100$ pF, $T_{amb} = 25$ °C, unity Gain		0.1			0.1		μ s
K_{ov}	Overshoot ($V_i = 20$ mV, $R_L = 2$ k Ω) $C_L \leq 100$ pF, $T_{amb} = 25$ °C, unity gain)		10			10		%
GBP	Gain Bandwidth Product ($f = 100$ kHz, $T_{amb} = 25$ °C) $V_n = 10$ mV, $R_L = 2$ k Ω , $C_L = 100$ pF)	3.3	4.0	5.0	3.3	4.0	5.0	MHz
R_i	Input Resistance ($T_{amb} = 25$ °C)		10^{12}			10^{12}		Ω
THD	Total Harmonic Distortion ($f = 1$ kHz, $A_v = 20$ dB, $R_L = 2$ k Ω) $C_L < 100$ pF, $T_{amb} = 25$ °C, $V_o = 2$ V _{pp})		0.01			0.01		%
V_n	Equivalent Input Noise Voltage ($f = 1$ kHz, $R_g = 100$ Ω)		15			15		nV/ \sqrt{Hz}
ϕ_m	Phase Margin		45			45		Degrees
V_{o1}/V_{o2}	Channel Separation $A_{vd} = 100$, $T_{amb} = 25$ °C		120			120		dB

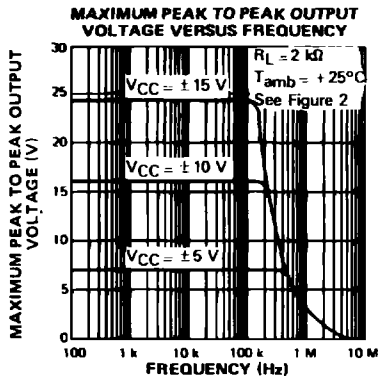

E88LF353-02

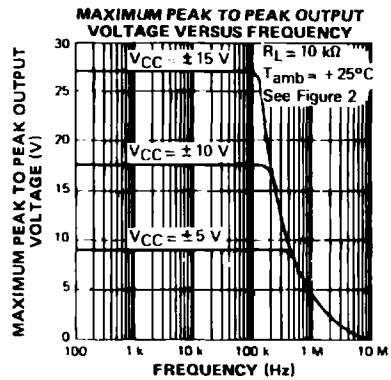

E88LF353-03

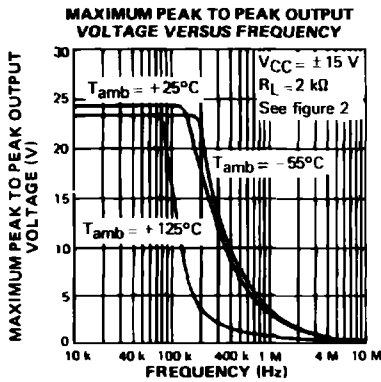

E88LF353-04

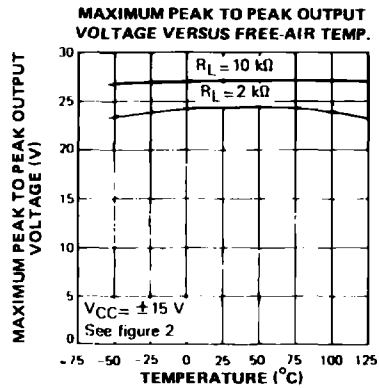

E88LF353-05

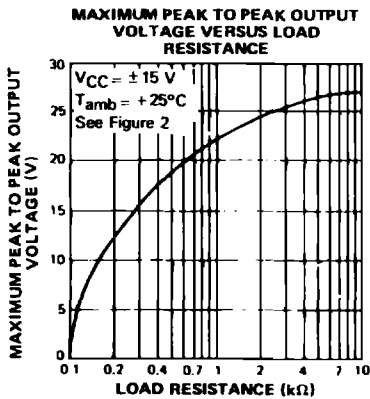

E88LF353-06

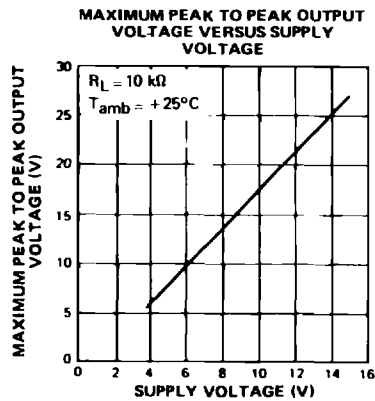

E88LF353-07

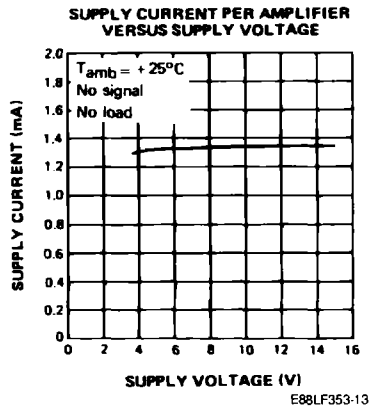
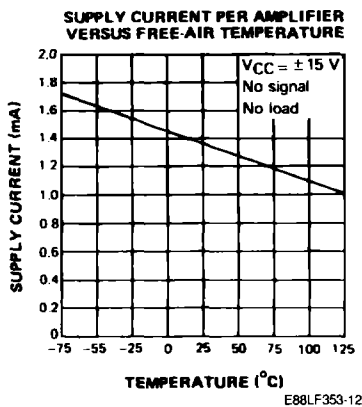
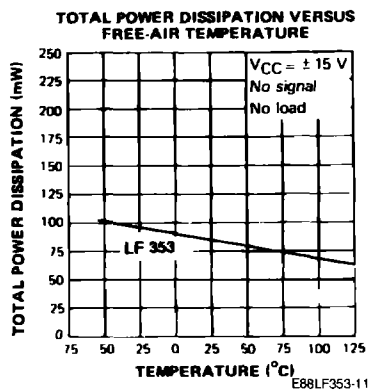
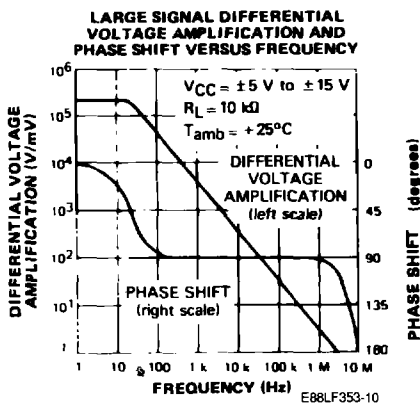
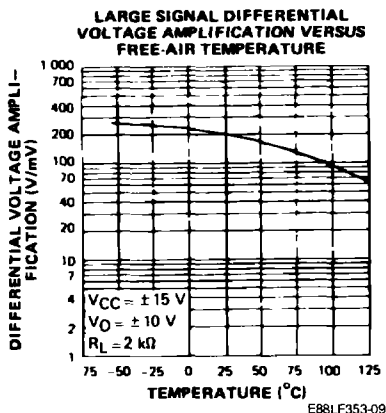
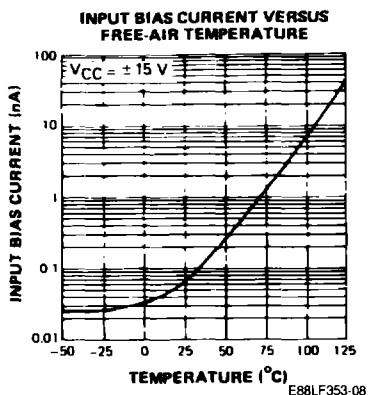

**COMMON MODE REJECTION RATIO
VERSUS FREE-AIR TEMPERATURE**

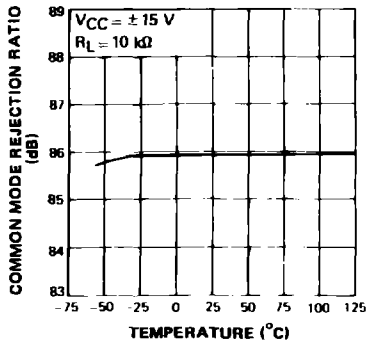

**VOLTAGE FOLLOWER LARGE
SIGNAL PULSE RESPONSE**

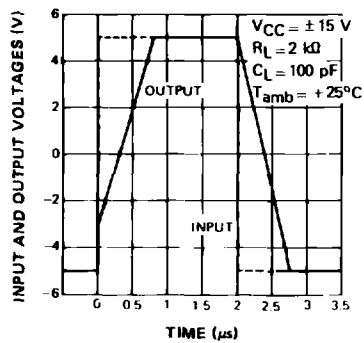

OUTPUT VOLTAGE VERSUS TIME

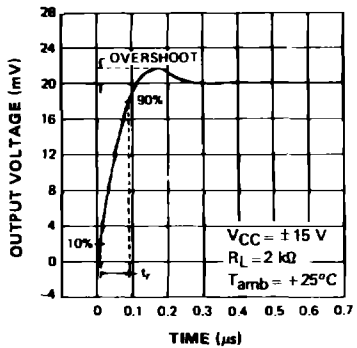

**EQUIVALENT INPUT NOISE VOL-
TAGE VERSUS FREQUENCY**

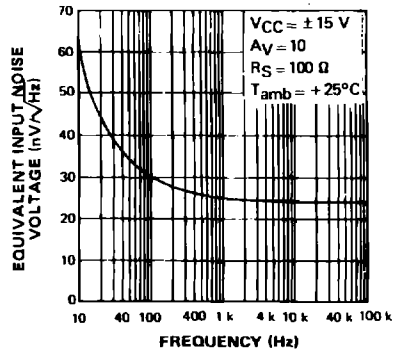

**TOTAL HARMONIC DISTORTION
VERSUS FREQUENCY**

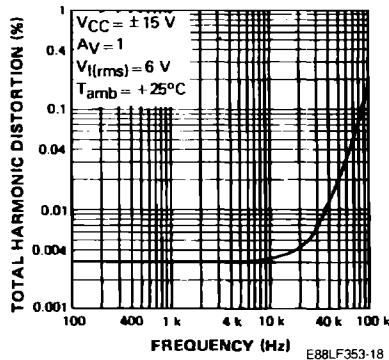

TYPICAL APPLICATION
QUADRATURE OSCILLATOR

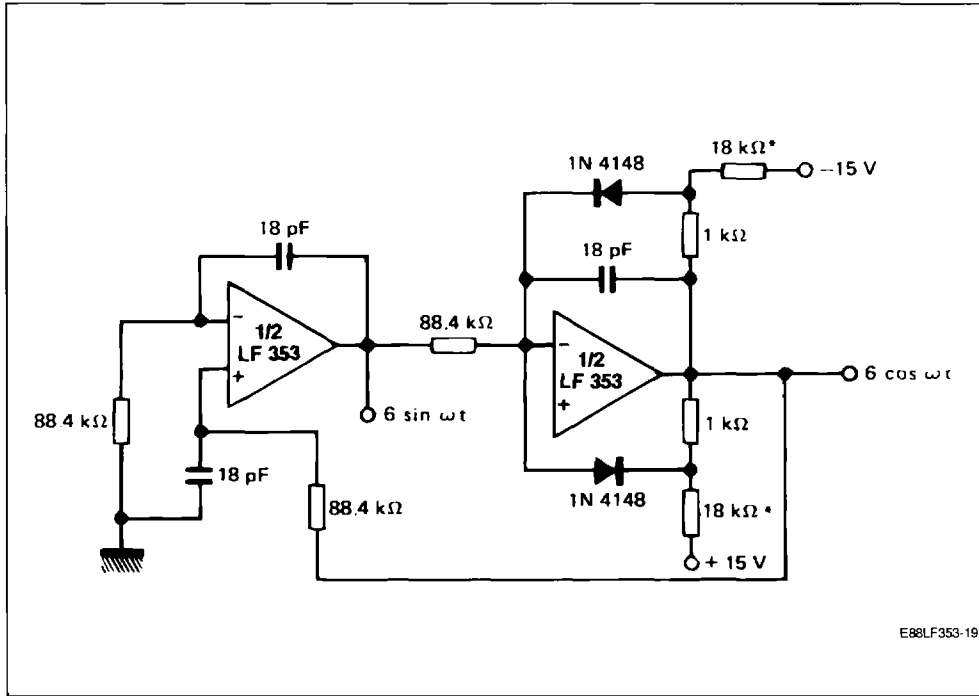

E88LF353-19

* These resistor values may be adjusted for a symmetrical output.

PARAMETER MEASUREMENT INFORMATION

Figure 1 : Voltage Follower.

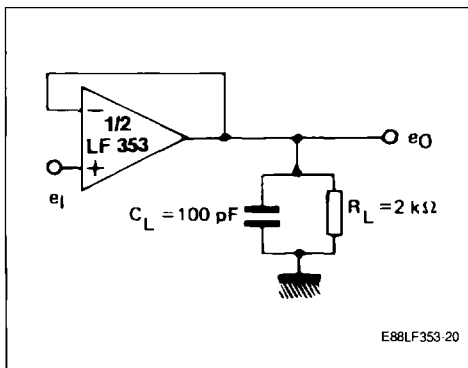

E88LF353-20

Figure 2 : Gain-of-10 Inverting Amplifier.

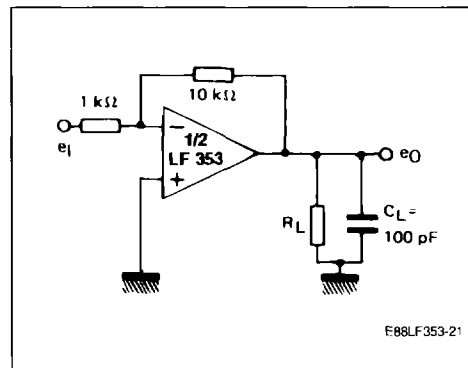

E88LF353-21

PACKAGE MECHANICAL DATA

20 PINS – TRICECOP (LCC)

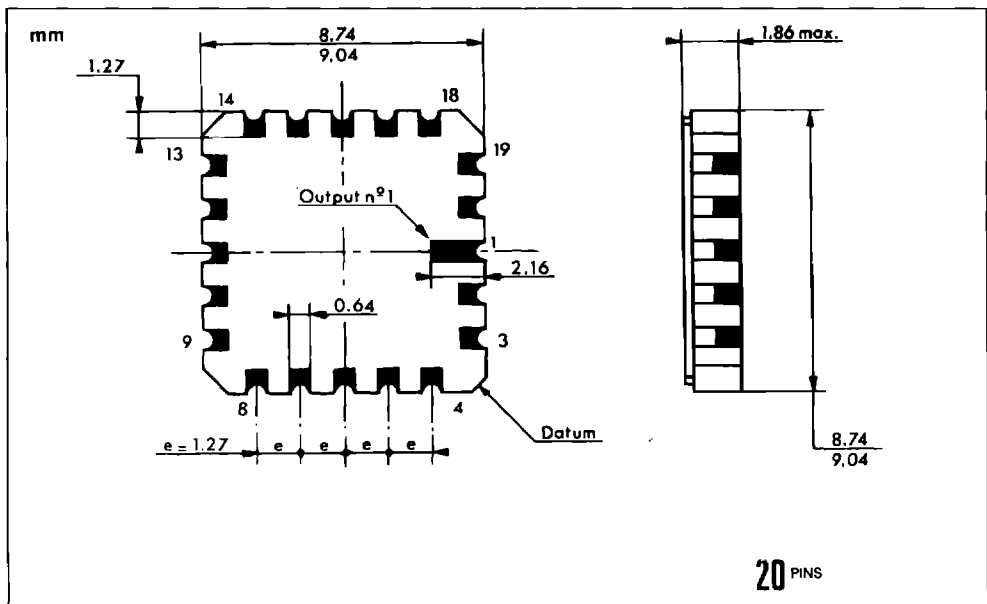

8 PINS – PLASTIC DIP

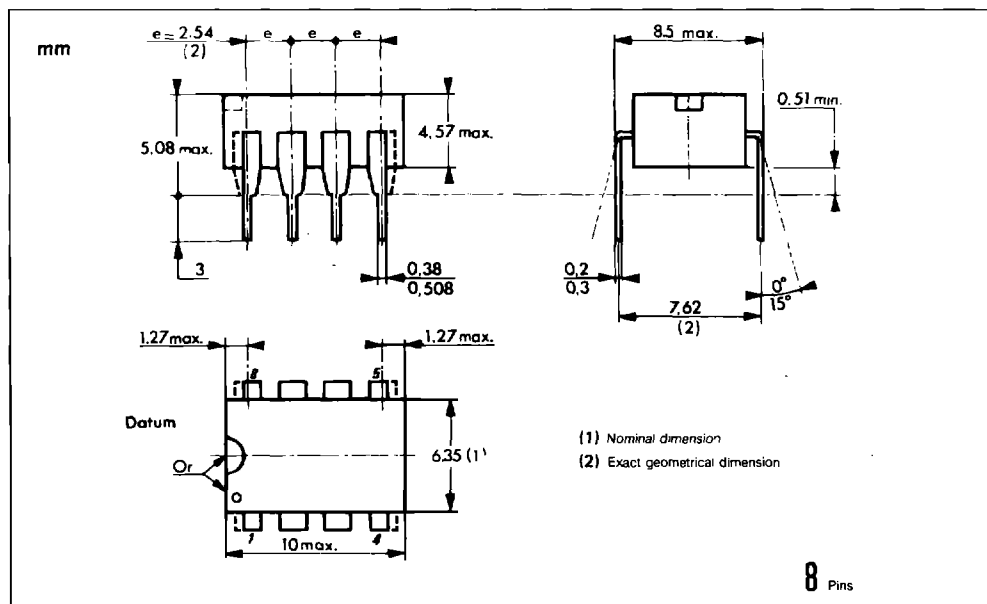

8 PINS – PLASTIC MICROPACKAGE (SO)

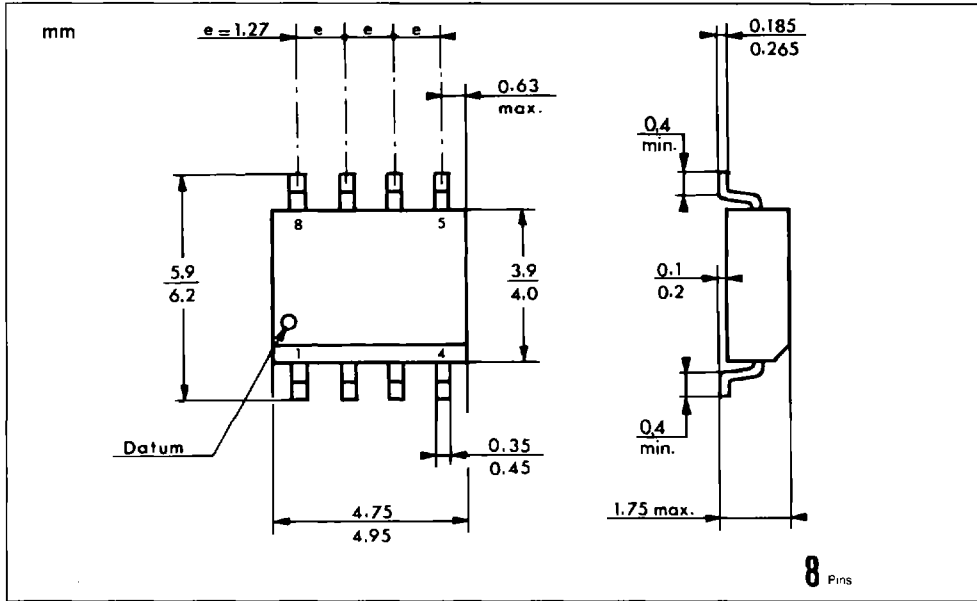

TO99 – METAL CAN

