

# SPECIFICATION

Patent Pending

- Part No. : PA.700. A Viking
- Product Name : Wide-Band LTE/Cellular/CDMA SMD Antenna  
For all in one 2G/3G/4G applications worldwide  
LTE/GSM / CDMA / DCS / PCS / WCDMA / UMTS  
/HSDPA / GPRS / EDGE  
698MHz to 960MHz  
1710MHz to 2170Mhz
- Feature : High efficiency wide-band antenna  
SMT for precision mounting and labor saving  
RoHS ✓



# 1. Introduction

This revolutionary patent pending PA.700A Viking is a 2G/3G/4G High Efficiency SMD Ceramic antenna operating at 700MHz to 960MHz, 1710MHz to 2200MHz. It uses high grade ceramics to deliver the highest efficiencies on all bands on the shortest device ground-plane lengths possible. The exceptional wide-band response means it is the ideal antenna for LTE 700MHz applications that also need high efficiency 2G or 3G on lower and upper bands.

The PA.700 is a unique solution which is delivered on tape and reel. For very detailed integration information additional to this specification please download our comprehensive PA-700 integration application note from our website.

## 1.1 Key Advantages

1. Highest efficiency in small size 40mm\*6mm\*5mm. A comparative metal, FR4, FPC, whip, rod, and helix antenna would have much more reduced efficiency in this configuration for the same size due to their different dielectric constants. Very high efficiency antennas are critical to 3G and 4G devices ability to deliver the stated data-speed rates of systems such as HSPA and LTE.
2. More resistant to detuning compared to other antenna integrations. If tuning is required it can be tuned for the device environment using a matching circuit or other techniques. There is no need for new tooling, thereby saving money if customization is required.
3. Highly reliable and robust- its predecessor the PA.25 antenna is used by the world's leading auto makers in extremely challenging environments. The antenna meets all temperature and mechanical specs required (vibration, drop tests etc)
4. Rectangular shape - Easy to integrate. Other antenna designs come in irregular shapes and sizes making them hard to integrate.
5. SMD (On-Board) antenna saves on labor, cable and connector costs, leads to higher integration yield rates, and reduces losses in transmission.
6. It mounts directly on edge of device main-board.
7. Transmission losses are kept to absolute minimum resulting in much improved over the air (OTA) TRP(Total Radiated Power)/TIS(Total Isotropic Radiation) device performance compared to similar efficiency cable and connector antenna solutions, thus being an ideal antenna to be used for devices that need to pass network approvals from for example AT&T or Verizon.
8. Reductions in probability of radiated spurious emissions compared to other antenna technologies are observed when using the PA-700 and strictly following this application note layout
9. Achieves moderate to high gain in both vertical and horizontal polarization planes. This feature is very useful in certain wireless communications where the antenna orientation is not fixed and the reflections or multipath signals may be present from any plane. In those cases the important parameter to be considered is the total field strength, which is the vector sum of the signal from the horizontal and vertical polarization planes at any instant in time.

## 2. Specification

ELECTRICAL						
Frequency (MHz)	700~ 800	824 ~ 896	880 ~ 960	1710~ 1880	1850~1990	1710~2170
Peak Gain (dBi)	2.0	1.4	0.9	3.7	3.9	4.1
Average Gain (dBi)	-2.3	-1.8	-2.5	-1.6	-1.4	-1.8
Efficiency	61%	66%	56%	69%	72%	67%
VSWR	< 3.0 : 1					
Impedance	50Ω					
Polarization	Linear					
Radiation Pattern	Omni					
MECHANICAL						
Dimensions	40 x 6 x 5 mm					
Termination	Ag (environmental-friendly Pb free)					
ENVIRONMENTAL						
Operation Temperature	-40°C to 85°C					
Humidity	Non-condensing 65°C 95% RH					

\* All electrical properties are measured with PA.700 mounted on its EVB with 140x40mm ground.

### 3. Antenna Characteristics

#### 3.1. Return Loss

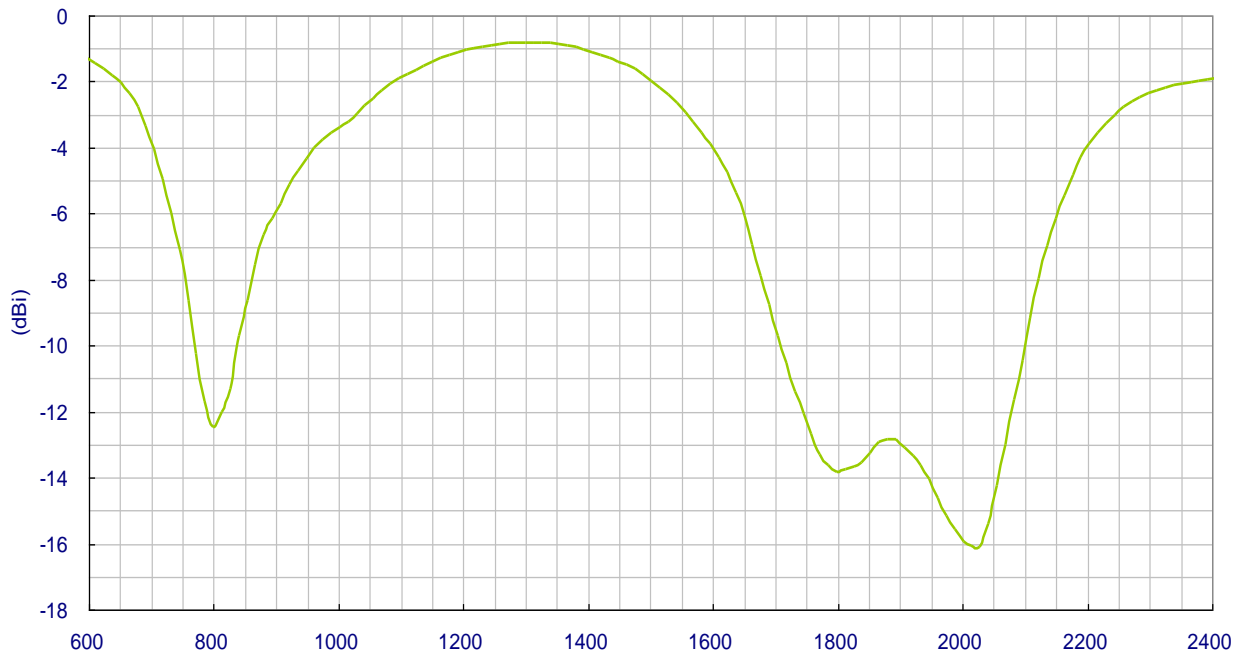

#### 3.2. VSWR

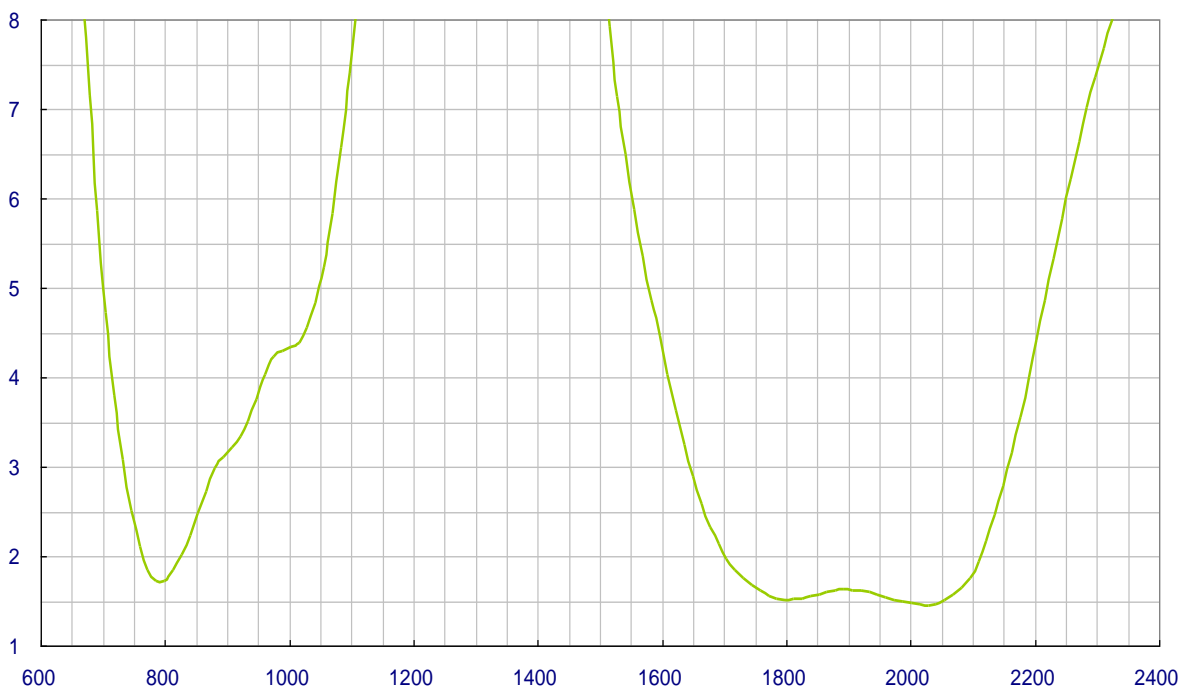

### 3.3. Efficiency

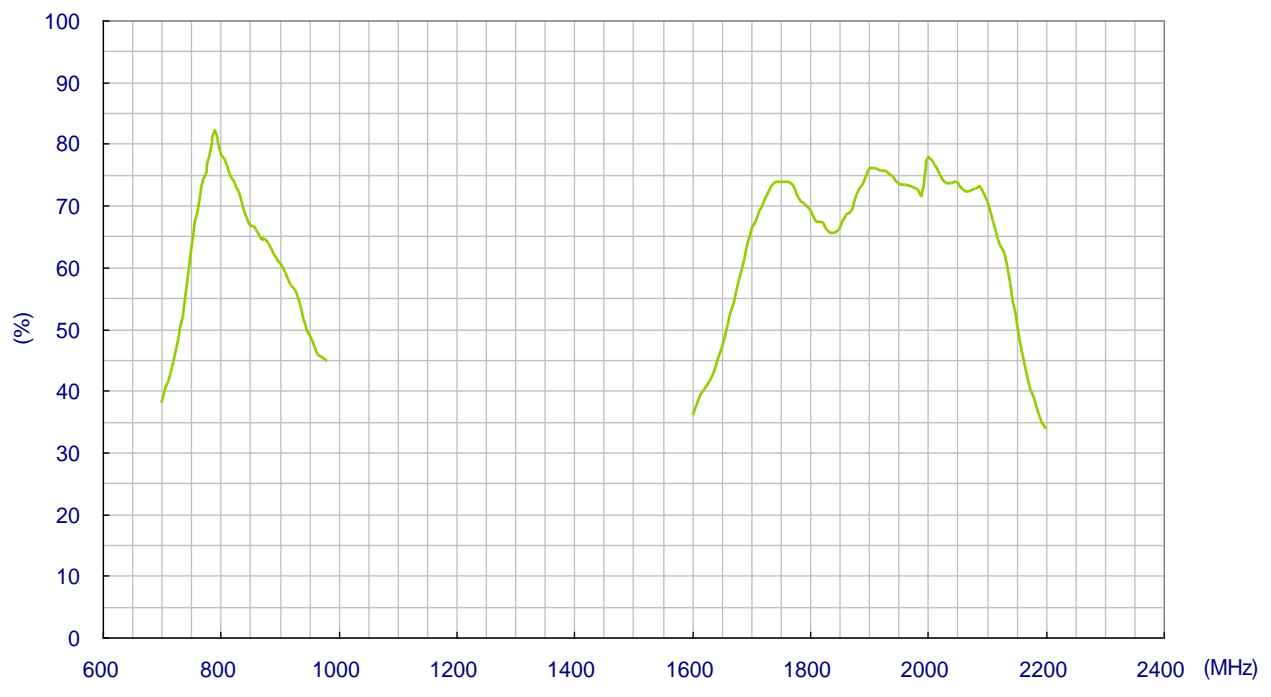

### 3.4. Peak Gain

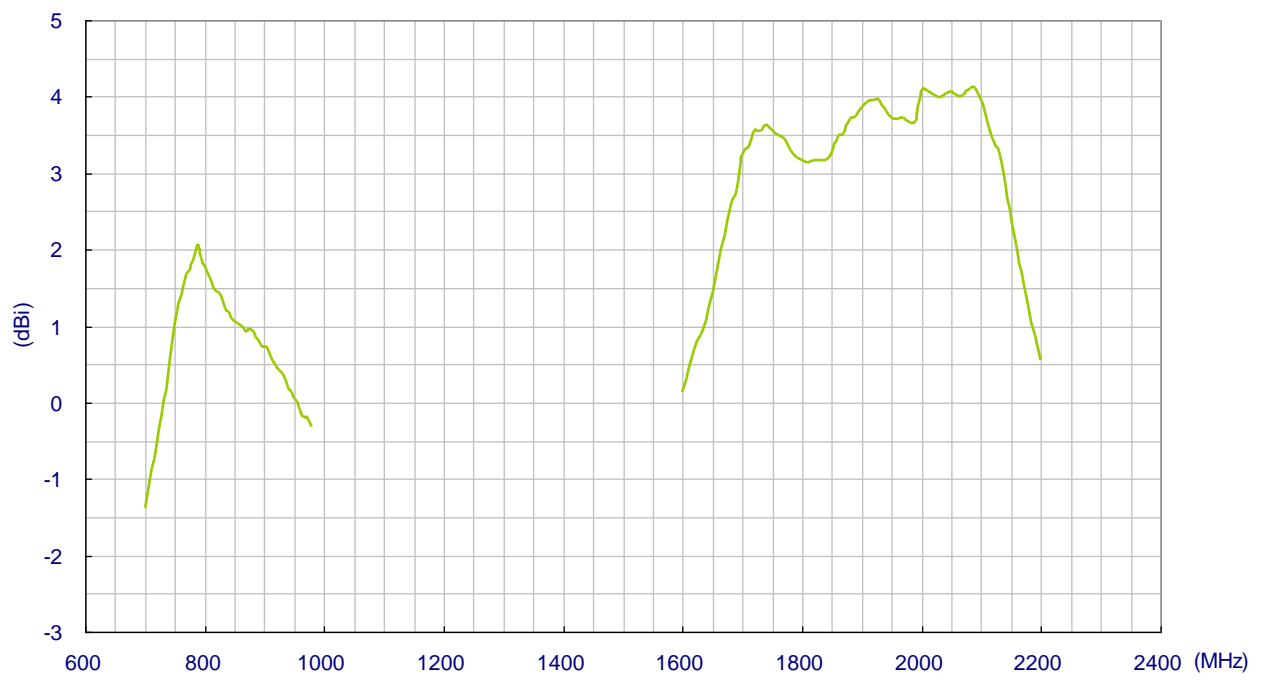

### 3.5. Average Gain

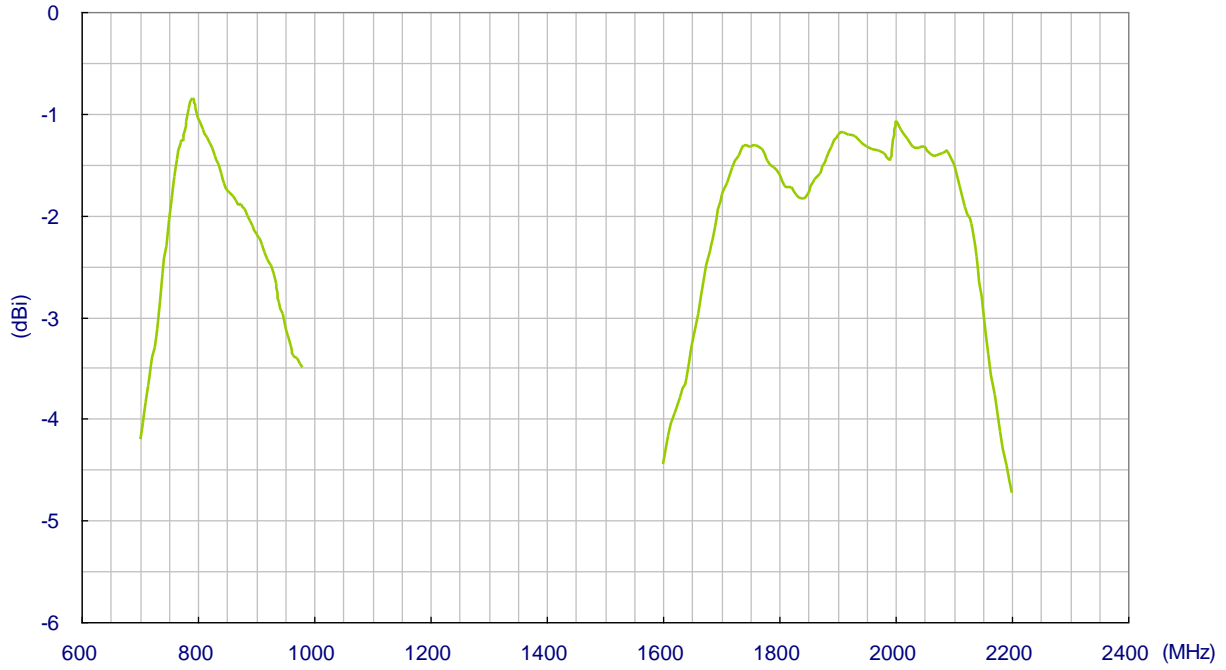

### 3.6. Antenna Radiation Pattern

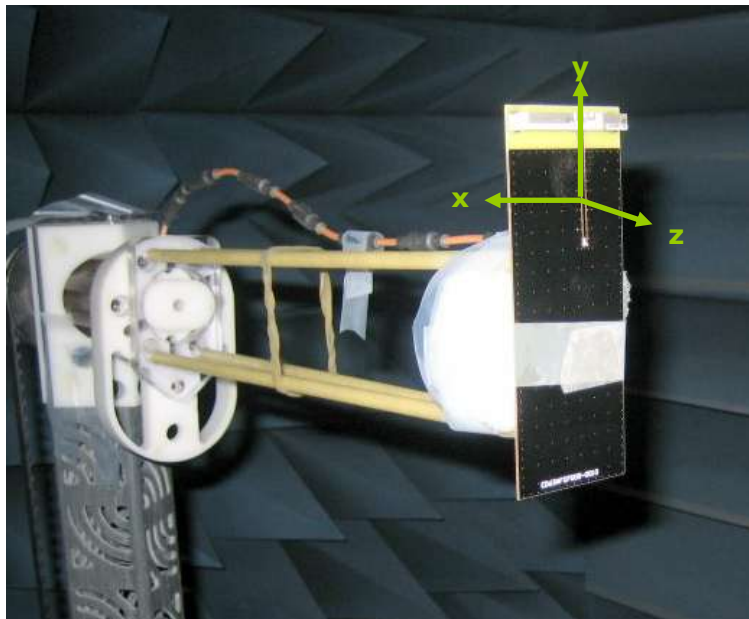

### X-Y Plane Radiation

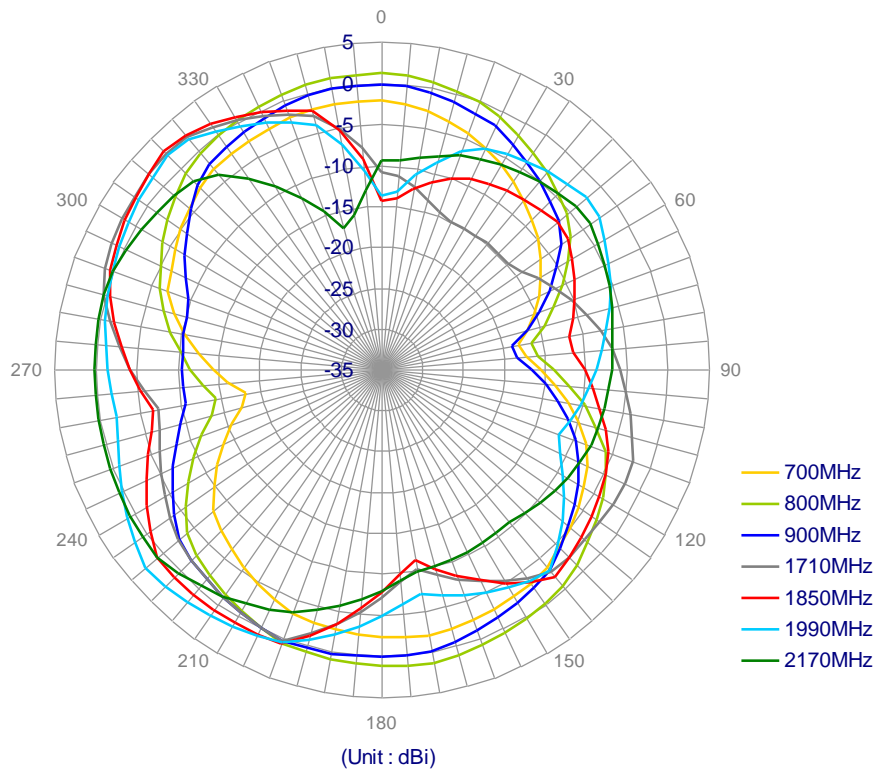

### X-Z Plane Radiation

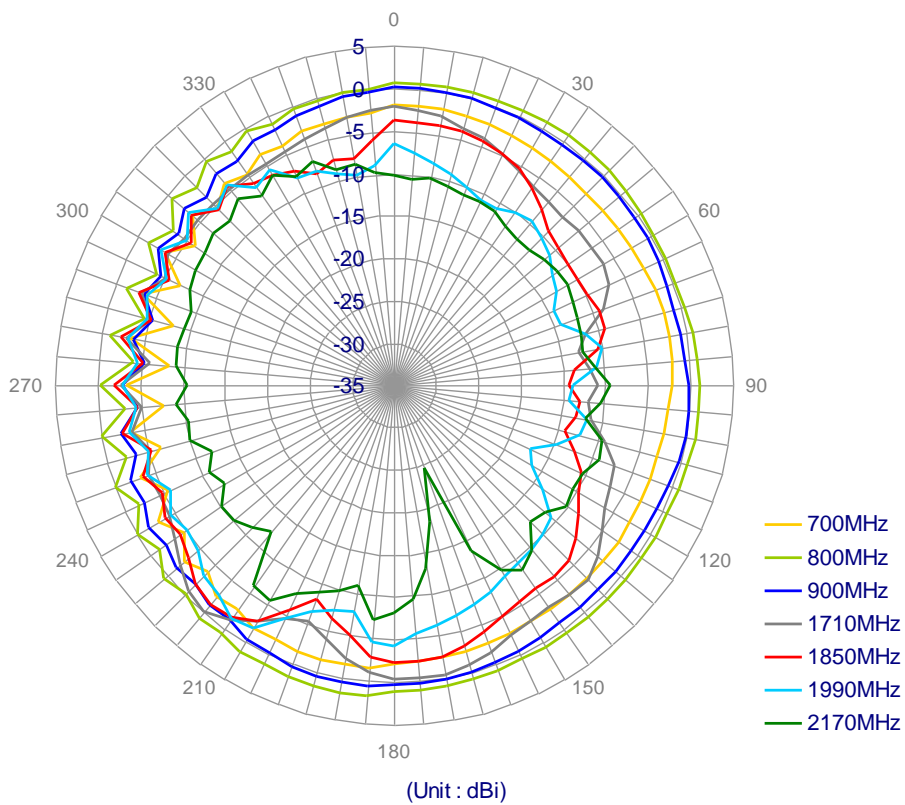

# 4. Mechanical Drawing

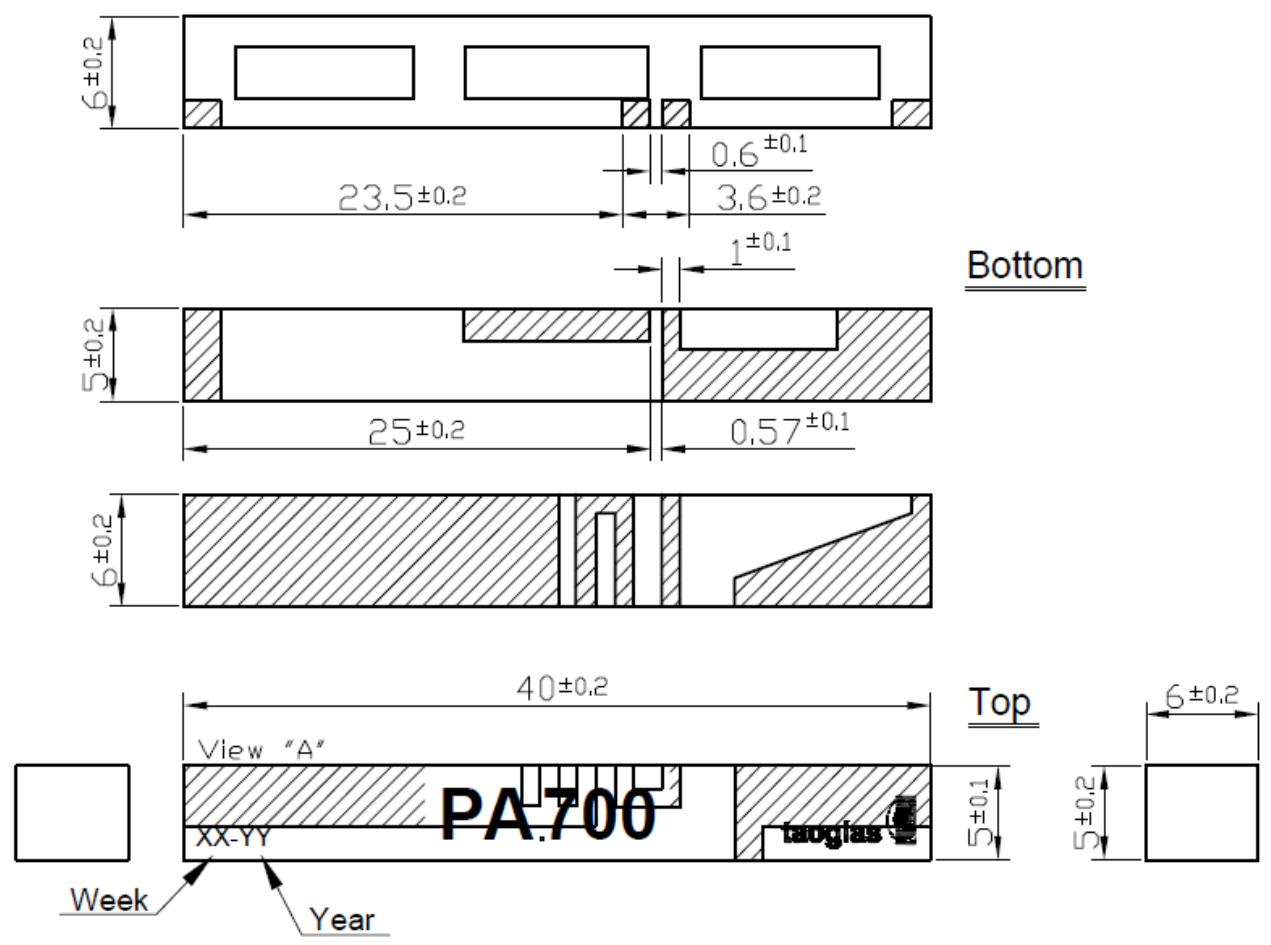



## 5. Layout Dimensions

### Footprint 0.8t PCB

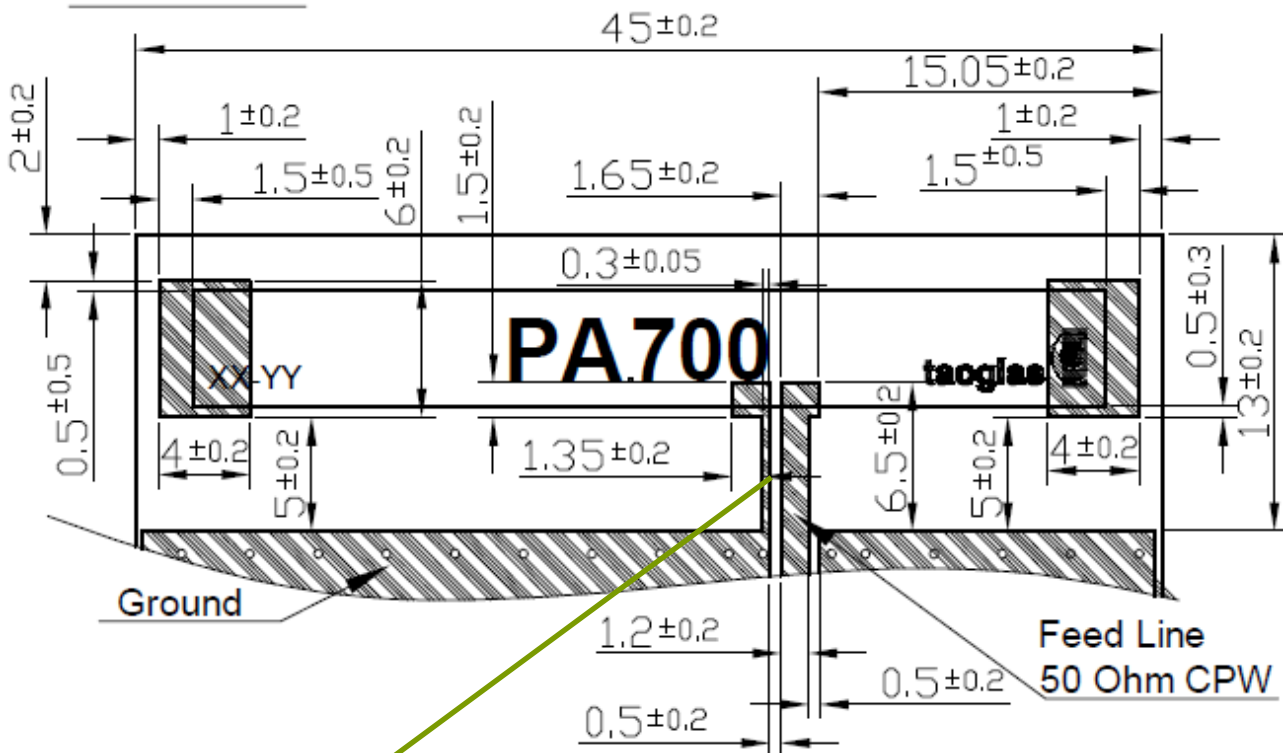

Note: Inductor Value 8.2nH for Taoglas  
 Evaluation Board – different values may be  
 required for different board designs

Size	Description
0402	8.2nH Inductor (MLK1005S8N2D)

## 6. EVB Dimensions

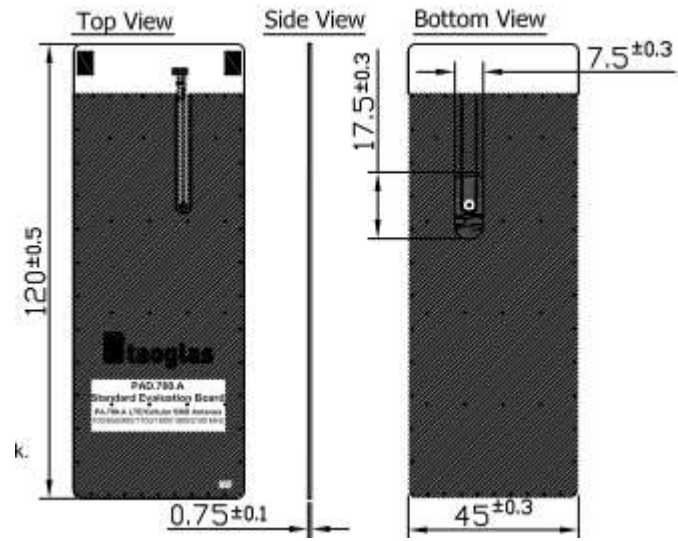

## 7. Packing

Blister tape to IEC 286-3, Polyester

Pieces / Tape = 450

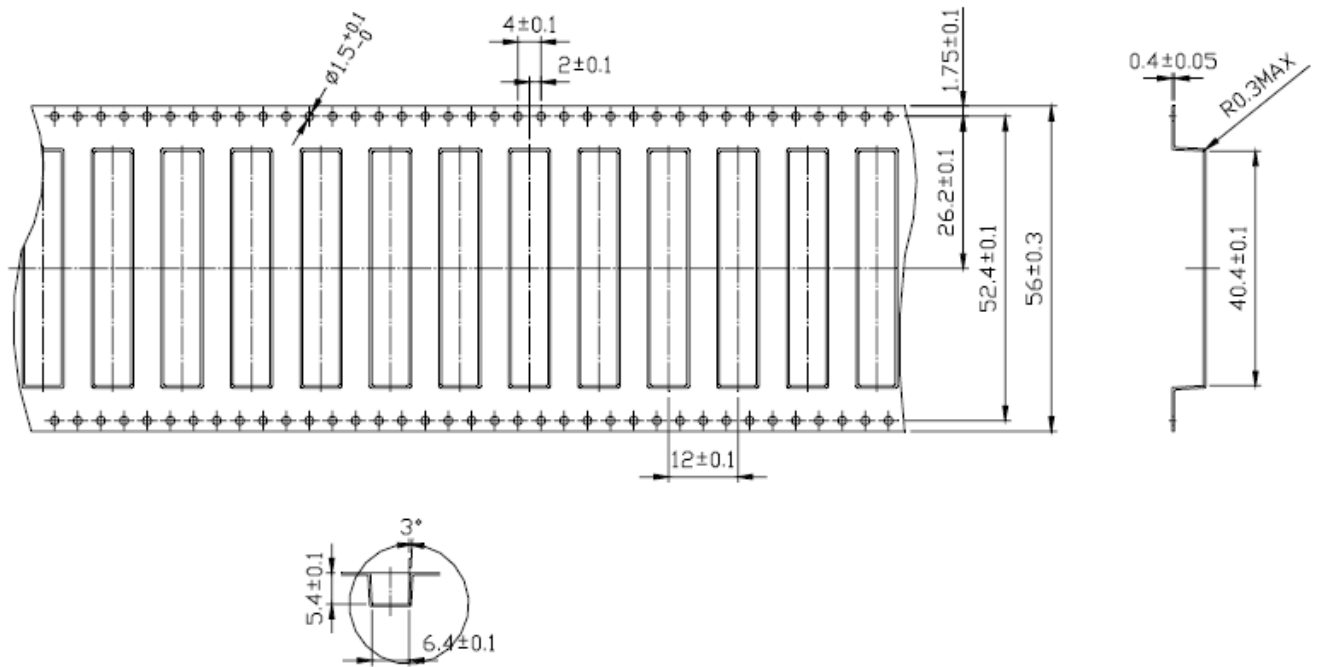
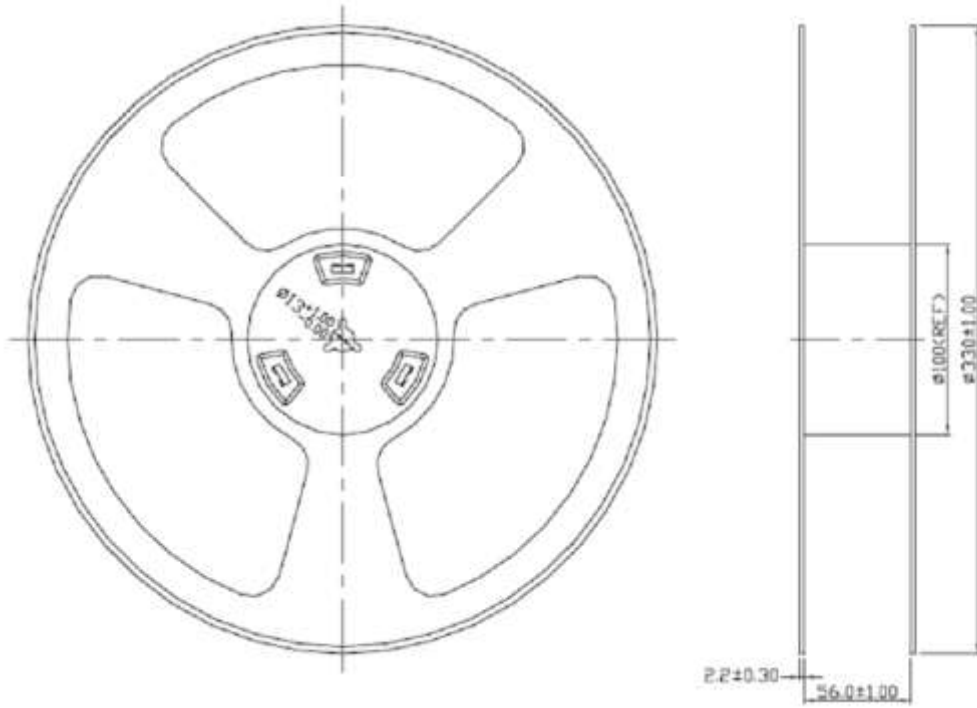

## 8. Recommended Reflow Profile

PA.700 can be assembled following either Sn-Pb or Pb-Free assembly processes. The recommended soldering temperatures are as follows:

Phase	Profile Features	Sn-Pb Assembly	Pb-Free Assembly (SnAgCu)
Ramp-Up	Avg. Ramp-Up Rate (T <sub>smax</sub> to T <sub>P</sub> )	3°C/second (max)	3°C/second (max)
Preheat	Temperature Min (T <sub>smin</sub> )	100°	100°
	Temperature Max (T <sub>smax</sub> )	150°	150°
	Time (t <sub>smin</sub> to t <sub>smax</sub> )	60-120 seconds	60-120 seconds
Reflow	Temperature (T <sub>L</sub> )	183°C	217°C
	Total Time Above T <sub>L</sub> b(t <sub>L</sub> )	60-150 seconds	60-150 seconds
Peak	Temperature (T <sub>p</sub> )	235°C	260°C
	Time (t <sub>p</sub> )	10-30 seconds	20-40 seconds
Ramp-Down	Rate	6°C/second (max)	6°C/second (max)
Time from 25°C to peak Temperature		6 minutes max	8 minutes max

### Temperature profile – (green area) for the assembly process in reflow ovens

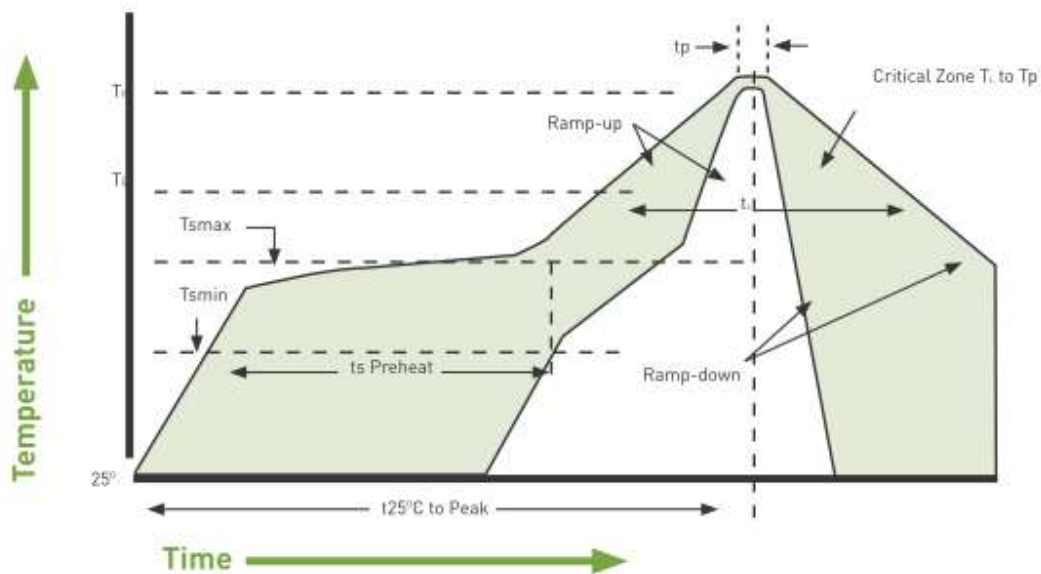

Temperature profile – (green area) for the assembly process in reflow ovens