

DESCRIPTION

The MP2606 is a linear, high-performance single cell Li-Ion battery charger. By integrating high voltage input protection into the charger IC, the MP2606 can tolerate an input surge up to 28V.

The device features constant current (CC) and constant voltage (CV) charging modes with programmable charge currents (85mA to 1A), programmable battery full threshold, thermal protection and reverse current blocking. The device also provides AC adapter power good and charge status indications to the system.

MP2606 is available in 10-pin 3mm x 3mm QFN package.

EVALUATION BOARD REFERENCE

Board Number	Dimensions
EV2606DQ-00A	2.0" x 1.9" x 0.6"

FEATURES

- Input Surge up to 28V
- Adapter or USB Input
- Programmable Charge Current: 85mA to 1A
- Proprietary Constant Voltage Auto Recharge
- Proprietary Over-Voltage Protection
- 0.75% V_{BATT} Accuracy
- $<1\mu A$ Battery Reverse Current
- 90 μA Standby Current from V_{IN}
- Over Current Protection
- AC Adapter Power Good Indicator
- Charge Status Indicator
- Programmable Soft-Start
- Programmable Charge Termination Current Threshold
- Tiny 3mm x 3mm QFN Package

APPLICATIONS

- Cell Phones
- MP3/Multimedia Players
- Smart Phones
- PDAs
- Digital Cameras

"MPS" and "The Future of Analog IC Technology" are Registered Trademarks of Monolithic Power Systems, Inc.

TYPICAL APPLICATION

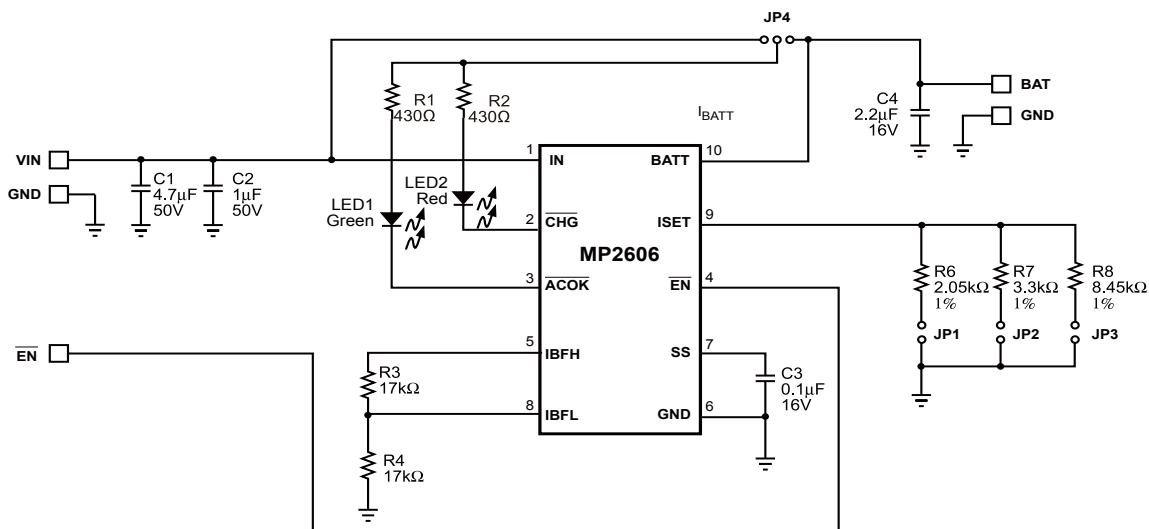

PACKAGE REFERENCE

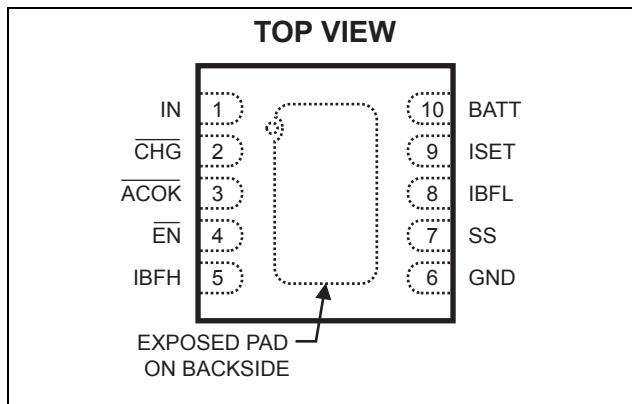

Part Number*	Package	Temperature
MP2606DQ	QFN10 (3mm x 3mm)	-40°C to +85°C

* For Tape & Reel, add suffix -Z (e.g. MP2606DQ-Z)
 For RoHS Compliant Packaging, add suffix -LF
 (e.g. MP2606DQ-LF-Z)

ABSOLUTE MAXIMUM RATINGS (1)

IN to GND -0.3V to +28V
 All Other Pins to GND -0.3V to +6.5V
 Junction Temperature 140°C
 Lead Temperature 260°C
 Storage Temperature -65°C to +150°C

Recommended Operating Conditions (2)

Nominal Supply Voltage V_{IN} 3.5V to 6.5V
 Operating Temperature -40°C to +85°C

Thermal Resistance (3) θ_{JA} θ_{JC}
 3x3 QFN10 50 12... °C/W

Notes:

- 1) Exceeding these ratings may damage the device.
- 2) The device is not guaranteed to function outside of its operating conditions.
- 3) Measured on approximately 1" square of 1 oz copper.

ELECTRICAL CHARACTERISTICS

$V_{IN} = 5V$, $V_{EN} = 0V$, $T_A = +25°C$, unless otherwise noted.

Parameter	Symbol	Condition	Min	Typ	Max	Units
Supply Current	I_{SUPPLY}	$\overline{EN} = \text{High}$		40		μA
		$\overline{EN} = \text{Low}$, $I_{CHG} = 0A$		500		
Battery Voltage Regulation	V_{BATT}	$T = +25°C$, $I_{BATT} = 0$	4.179	4.20	4.221	V
		$T = 0°C$ to $+50°C$, $I_{BATT} = 0$	4.168	4.20	4.232	
		$T = -5°C$ to $+75°C$, $I_{BATT} = 0$	4.158	4.20	4.242	
Battery Over-Voltage Protection	I_{BATT_OVP}	$V_{BATT} = 4.25V$			0	μA
Constant Current Regulation	I_{CHG}	$V_{IN} = 5V$, $V_{BATT} = 3.8V$ $R_{CHG} = 3.3k\Omega$	450	515	580	mA
Constant Current Variation		$V_{IN} = 5V$, $V_{BATT} = 3.8V$, $T_J = 0°C$ to $+120°C$, $R_{CHG} = 1.6k\Omega$ to $8.0k\Omega$	87	100	113	$\%I_{CHG}^{(4)}$
Battery Full Programming Range	I_{BF}	Refer to Operation section for programming I_{BF}	10		50	$\%I_{CHG}^{(4)}$
IBF Accuracy			75		125	$\%I_{BF}^{(5)}$
SS Pin Voltage		$C_{SS} = 0.1\mu F$, $V_{BATT} = 3.6V$	1.19	1.23	1.27	V
Input \overline{ACOK} Up Range			6.8	7.0	7.2	V
Input \overline{ACOK} Low Range			1.8	2.5	3.2	V
\overline{EN} Trip Threshold High			2.0			V
\overline{EN} Trip Threshold Low					0.4	V

ELECTRICAL CHARACTERISTICS *(continued)*
 $V_{IN} = 5V$, $V_{EN} = 0V$, $T_A = +25^{\circ}C$, unless otherwise noted.

Parameter	Symbol	Condition	Min	Typ	Max	Units
\overline{CHG} , \overline{ACOK} Sink Current		Pin Voltage = 0.4V	8			mA
Battery Reverse Current to BATT Pin		$\overline{EN} = \text{Low}$ and Input = Floating or 0V			1	μA
TBD TBD Switch-On Resistance	R_{ON}	$V_{BATT} = 3.8V$, $I_{BATT} = 300mA$, $R_{CHG} = 1.7k\Omega$		0.35		Ω
Soft Thermal Shutdown Threshold			105	120	135	$^{\circ}C$
Soft Thermal Shutdown Hysteresis				10		$^{\circ}C$
Soft-Start Time		$C_{SS} = 0.1\mu F$	10	20	35	ms

Notes:

- 4) I_{CHG} is the target preprogrammed charge current (Die temperature below 110 $^{\circ}C$).
 5) I_{BF} is the target preprogrammed battery full current threshold.

PIN FUNCTIONS

Pin #	Name	Description
1	IN	Input Supply Pin. IN receives the AC adapter or USB supply voltage.
2	\overline{CHG}	Open-Drain Charge Status Indicator. This pin is low during charging.
3	\overline{ACOK}	Open-Drain Input ACOK Indicator. This pin is low if the voltage at the IN pin is between 2.5V and 6V.
4	\overline{EN}	Charger IC Enable. An input "Low" signal at this pin or if the pin is floating will enable the IC.
5	IBFH	Change Status Hysteresis Program Pin. (See the formular on page 7)
6	GND	Ground.
7	SS	Soft-Start Timer. Connect this pin to an external capacitor to program the soft-start startup time using the equation: $T_{SS} = \frac{C_{SS}}{0.1\mu F} \times 20m \text{ sec.}$
8	IBFL	Charge Status Threshold Program. Connect this pin to an external resistor to program the charge termination current or battery full charge current.
9	ISET	Constant Charge Current Program. Connect this pin to an external resistor to program the charging current in CC Mode.
10	BATT	Charger Output.

TYPICAL PERFORMANCE CHARACTERISTICS

$V_{IN} = 5V$, $C_{IN} = 4.7\mu F$, $C_{OUT} = 2.2\mu F$, $T_A = +25^\circ C$, unless otherwise noted.

Disabled- Mode Supply Current vs. Input Voltage

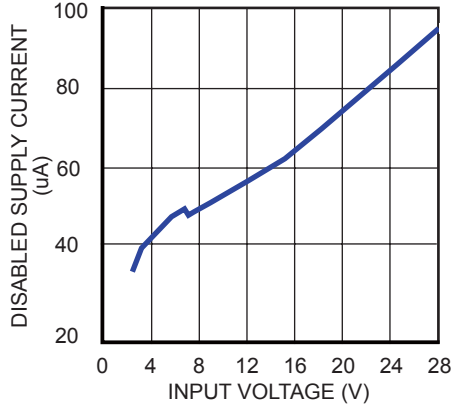

Reverse Current vs. Battery Voltage

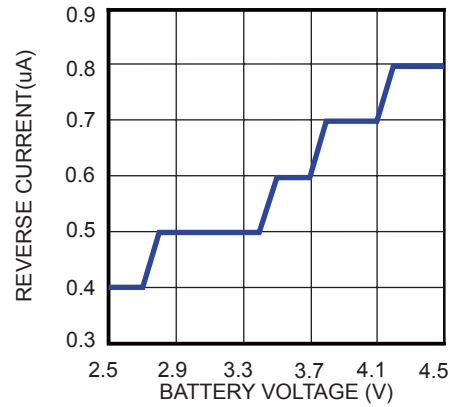

Charge Current Setting

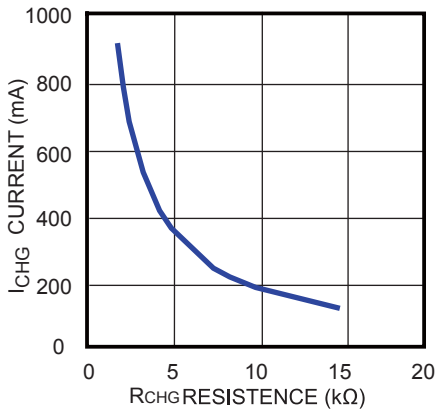

Battery Full Current Setting

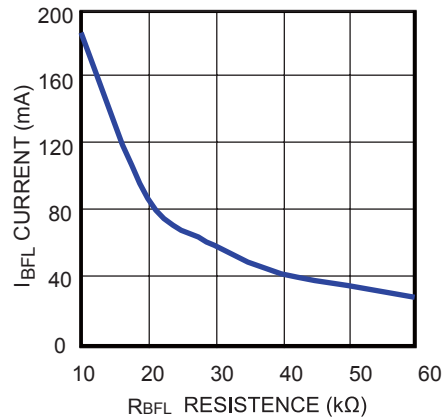

Constant Current Mode Charging

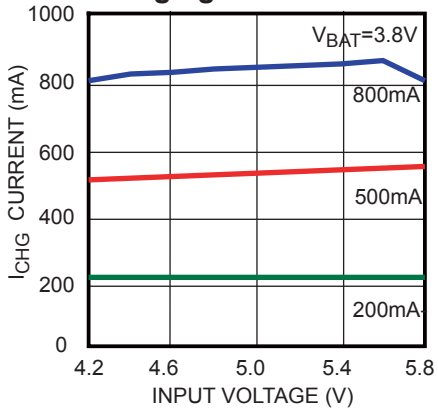

Charge Voltage vs RCHG Resistance

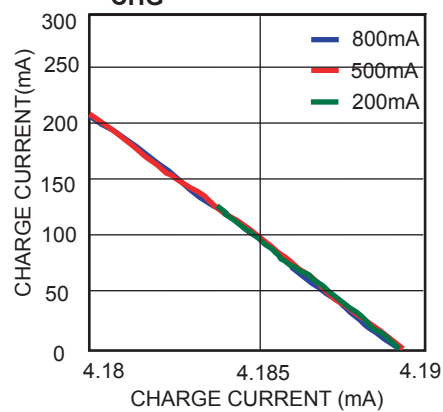

TYPICAL PERFORMANCE CHARACTERISTICS (continued)

$V_{IN} = 5V$, $C_{IN} = 4.7\mu F$, $C_{OUT} = 2.2\mu F$, $T_A = +25^\circ C$, unless otherwise noted.

Charge Current vs. Battery Voltage

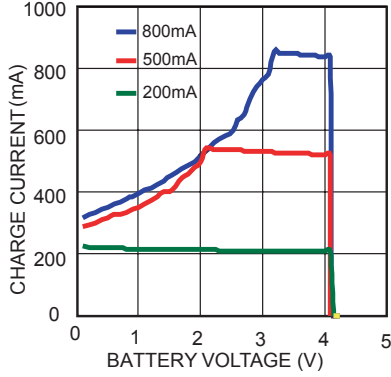

Battery Regulation Voltage vs. Ambient Temperature

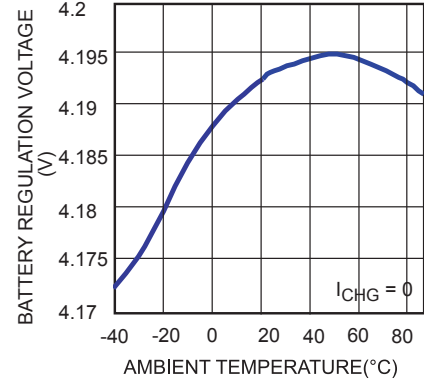

Charge Current(200mA) vs. Ambient Temperature

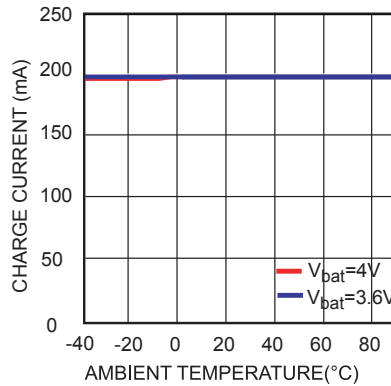

Charge Current(500mA) vs. Ambient Temperature

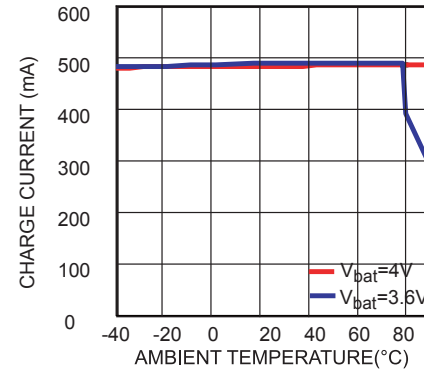

Charge Current(800mA) vs. Ambient Temperature

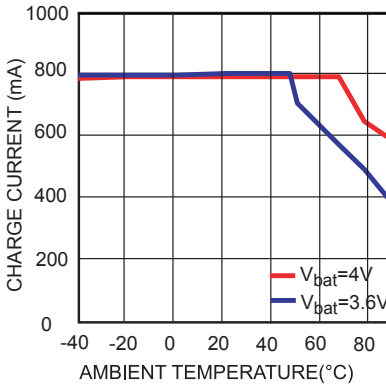

BLOCK DIAGRAM

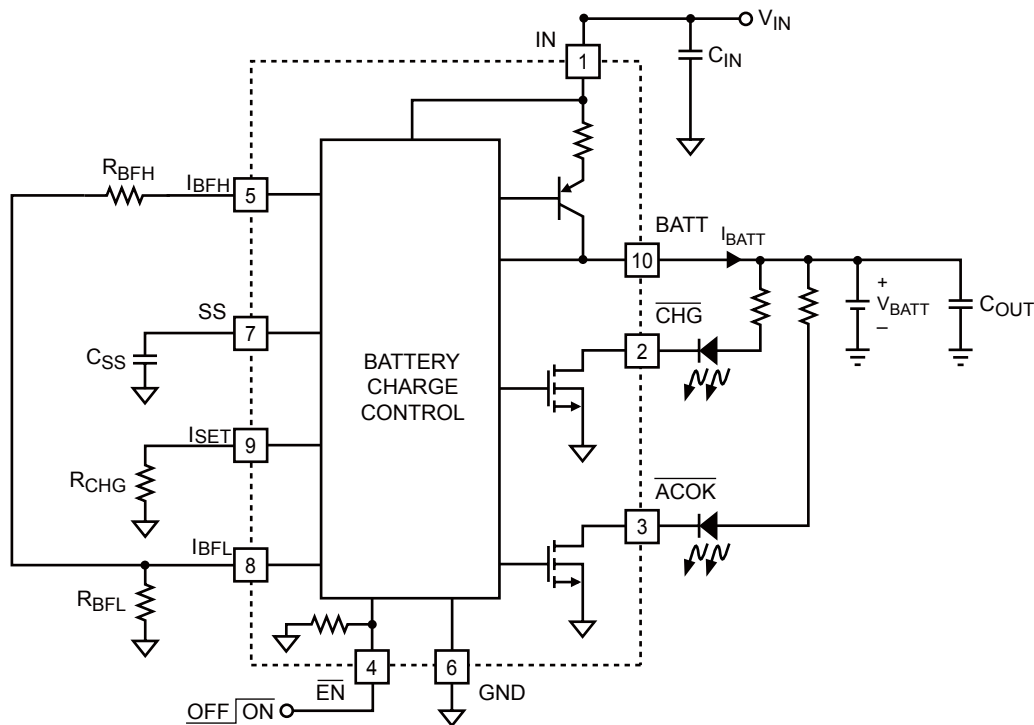

Figure 1—Functional Block Diagram

OPERATION

Input Voltage Range

The MP2606 has built-in input voltage surge protection as high as +28V. The charger IC will be automatically disabled when the input voltage is lower than 2.5V or higher than 7.0V. The open-drain pin $\overline{\text{ACOK}}$ is used to indicate an input power good condition (i.e. $2.5\text{V} < V_{\text{IN}} < 7.0\text{V}$). If the input voltage is lower than the battery voltage, the IC is also disabled to prevent the battery from draining.

Charge Cycle (Mode Change: CC-> CV)

Figure 2 below shows the typical charging profile for the MP2606. Figure 3 shows the typical charging procedure. For a depleted battery the MP2606 will start with the constant current of the programmed value (I_{CHG}). This is referred to as Constant Current (CC) mode. Once the battery voltage reaches 4.2V, the charger will operate in the constant voltage (CV) mode until the battery is fully charged. The charge current drops during CV mode, and the battery full indication is set when the charge current in the CV mode is reduced to the programmed full battery current (I_{BFL}). After battery full is asserted, the output current needs to reach I_{BFH} threshold to re-assert "In-charge" status.

The MP2606 can start up with heavy load and is stable without a battery connected to the BATT pin.

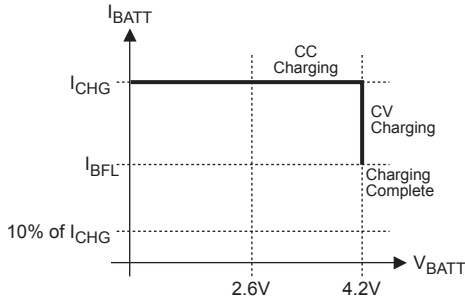

Figure 2—MP2606 Typical Charging Profile

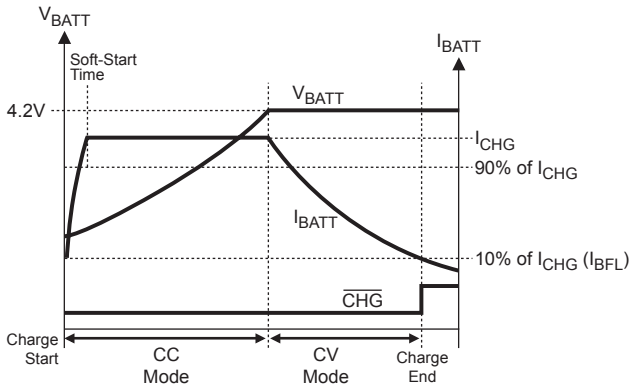

Figure 3—MP2606 Typical Charging Procedure

Battery Over-Voltage Protection and Automatic Recharge

At any time when V_{BATT} is 50mV higher than the trimmed charge target, the MP2606 reduces its charge current to 0 μ A. This ensures the safety of the battery. Also, the CV control loop always monitors the battery voltage such that it will automatically recharge the battery when it is depleted below the target level.

Programming of Charge Current and Battery Full Current

The charge current (I_{CHG}) is set by a resistor (R_{CHG}) connecting from the ISET pin to GND. The relationship of the charge current and the programming resistance is established by the following table and graph.

Table 1— R_{CHG} and I_{CHG} Relationship

R_{CHG} (k Ω)	I_{CHG} (mA)
1.82	913
2	835
2.16	778
2.5	677
3.32	521
4.32	410
5	357
7.5	236
8.45	208
10	176

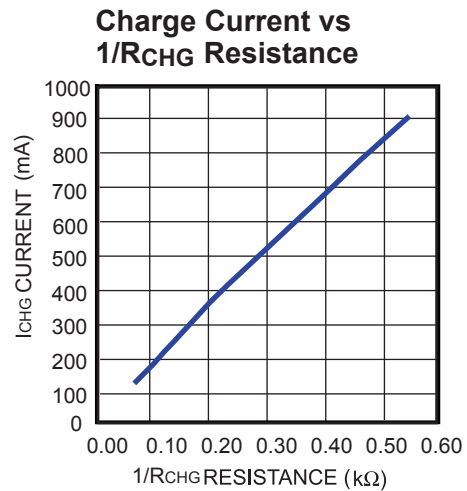

Figure 4—Charge Current vs $1/R_{CHG}$ Resistance

The recommended resistance for programming the charge current is $2.3k\Omega < R_{CHG} < 11k\Omega$. The battery full charge current threshold (I_{BFL}) is programmed by connecting a resistor R_{BFL} from the IBFL pin to GND:

$$(1) \quad I_{BFL} = \frac{1A \times 1.7k\Omega}{R_{BFL}}$$

$$(2) \quad I_{BFH} = \frac{1A \times 1.7k\Omega}{R_{BFH} // R_{BFL}}$$

Where $2R_{CHG} < R_{BFL} < 10R_{CHG}$. The open-drain pin \overline{CHG} is used to indicate charging status. When the battery full condition is reached or any other condition prevents the charger from charging, \overline{CHG} will become a floating pin.

Charge Status Indicator ($\overline{\text{CHG}}$)

The MP2606 has an integrated charge status pin that remains low while the battery is charging. Once the charge current has reduced to the battery full charge current threshold (I_{BFL}), the $\overline{\text{CHG}}$ pin will become high impedance.

Thermal Protection

The MP2606 has proprietary thermal protection to prevent the IC from overheating. When in thermal protection mode, the charge current becomes a saw-tooth waveform instead of a DC current. The average current of the saw-tooth waveform will be lower than the programmed DC charge current to prevent the IC from overheating. The frequency and amplitude of the saw-tooth current waveform can be altered by changing the capacitance value connected to the SS pin. Operating in thermal protection mode will slow down the charging process. Lowering the input voltage and enhancing thermal dissipation to the environment can effectively prevent the IC from going into thermal protection mode.

APPLICATION

Flow Chart of Operation

Power-On Reset (POR) feature can be applied to the MP2606 to ensure that the device starts operating in a known state. The flow chart in Figure 4 describes the conditions and operation

modes of the MP2606. CVC and CCC stand for “constant voltage charge” and “constant current charge”, respectively.

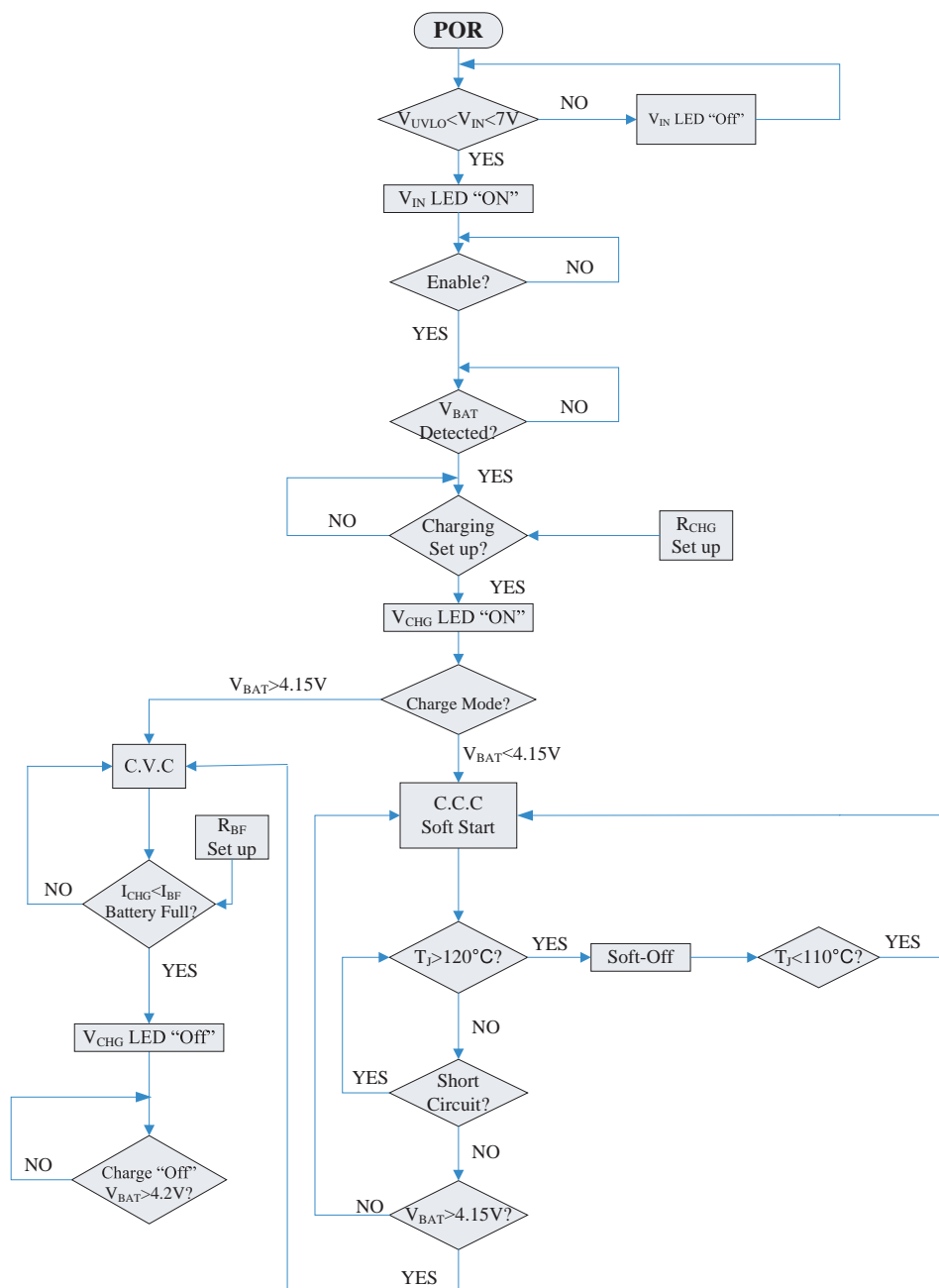

Figure 5—Flow Chart of Operation

