

Battery Charger and Step-Down Converter for Portable Applications

General Description

The AAT2556 is a member of Skyworks' Total Power Management IC (TPMIC™) product family. It is a fully integrated 500mA battery charger plus a 250mA step-down converter. The input voltage range is 4V to 6.5V for the battery charger and 2.7V to 5.5V for the step-down converter, making it ideal for single-cell lithium-ion/polymer battery-powered applications.

The battery charger is a complete constant current/ constant voltage linear charger. It offers an integrated pass device, reverse blocking protection, high current accuracy and voltage regulation, charge status, and charge termination. The charging current is programmable via external resistor from 15mA to 500mA. In addition to standard features, the device offers over-voltage, current limit, and thermal protection.

The step-down converter is a highly integrated converter operating at 1.5MHz of switching frequency, minimizing the size of external components while keeping switching losses low. It has independent input and enable pins. The output voltage ranges from 0.6V to the input voltage. The feedback and control deliver excellent load regulation and transient response with a small output inductor and capacitor.

The AAT2556 is available in a Pb-free, thermally-enhanced TDFN33-12 package and is rated over the -40°C to +85°C temperature range.

Features

- Battery Charger:
 - Input Voltage Range: 4V to 6.5V
 - Programmable Charging Current up to 500mA
 - Highly Integrated Battery Charger
 - Charging Device
 - Reverse Blocking Diode
- Step-Down Converter:
 - Input Voltage Range: 2.7V to 5.5V
 - Output Voltage Range: 0.6V to V_{IN}
 - 250mA Output Current
 - Up to 96% Efficiency
 - 30µA Quiescent Current
 - 1.5MHz Switching Frequency
 - 100µs Start-Up Time
- Short-Circuit, Over-Temperature, and Current Limit Protection
- TDFN33-12 Package
- -40°C to +85°C Temperature Range

Applications

- Bluetooth™ Headsets
- Cellular Phones
- Handheld Instruments
- MP3 and Portable Music Players
- PDAs and Handheld Computers
- Portable Media Players

Typical Application

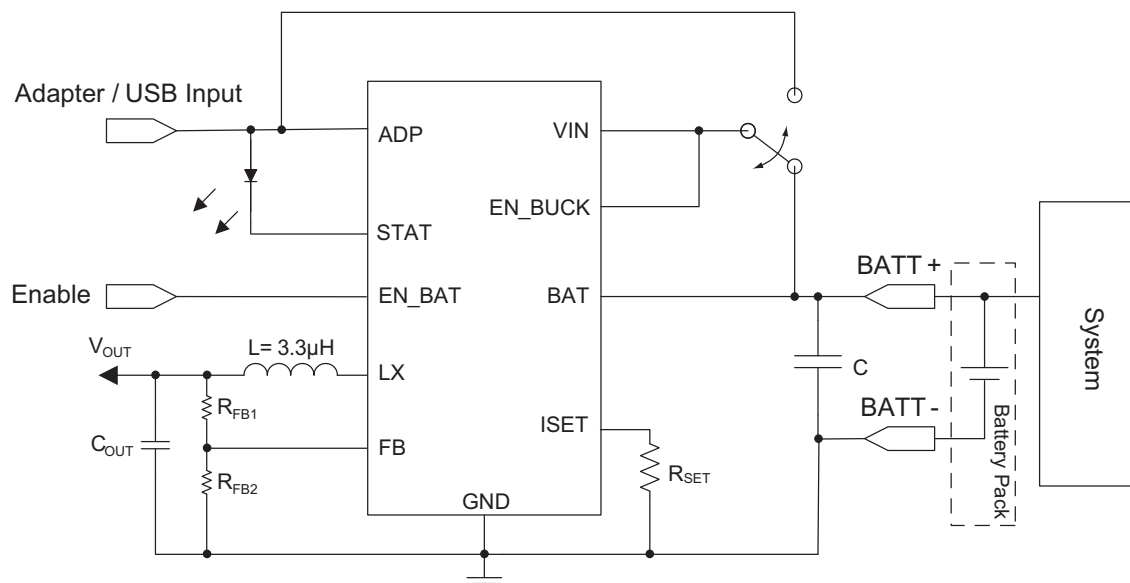

AAT2556

Battery Charger and Step-Down Converter for Portable Applications

Pin Descriptions

Pin #	Symbol	Function
1	FB	Feedback input. This pin must be connected directly to an external resistor divider. Nominal voltage is 0.6V.
2, 8, 10	GND	Ground.
3	EN_BUCK	Enable pin for the step-down converter. When connected to logic low, the step-down converter is disabled and it consumes less than 1µA of current. When connected to logic high, it resumes normal operation.
4	EN_BAT	Enable pin for the battery charger. When internally pulled down, the battery charger is disabled and it consumes less than 1µA of current. When connected to logic high, it resumes normal operation.
5	ISET	Charge current set point. Connect a resistor from this pin to ground. Refer to typical curves for resistor selection.
6	BAT	Battery charging and sensing.
7	STAT	Charge status input. Open drain status input.
9	ADP	Input for USB/adaptor charger.
11	LX	Output of the step-down converter. Connect the inductor to this pin. Internally, it is connected to the drain of both high- and low-side MOSFETs.
12	VIN	Input voltage for the step-down converter.
EP		Exposed paddle (bottom): connect to ground directly beneath the package.

Pin Configuration

**TDFN33-12
(Top View)**

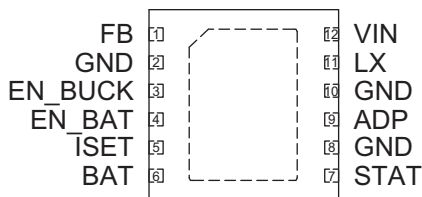

Battery Charger and Step-Down Converter for Portable Applications**Absolute Maximum Ratings¹**

Symbol	Description	Value	Units
V _{IN}	Input Voltage to GND	6.0	V
V _{ADP}	Adapter Voltage to GND	-0.3 to 7.5	V
V _{LX}	LX to GND	-0.3 to V _{IN} + 0.3	V
V _{FB}	FB to GND	-0.3 to V _{IN} + 0.3	V
V _{EN}	EN_BAT and EN_BUCK to GND	-0.3 to 6.0	V
V _X	BAT, ISET and STAT to GND	-0.3 to V _{ADP} + 0.3	V
T _J	Operating Junction Temperature Range	-40 to 150	°C
T _{LEAD}	Maximum Soldering Temperature (at leads, 10 sec)	300	°C

Thermal Information

Symbol	Description	Value	Units
P _D	Maximum Power Dissipation	2.0	W
θ _{JA}	Thermal Resistance ²	50	°C/W

1. Stresses above those listed in Absolute Maximum Ratings may cause permanent damage to the device. Functional operation at conditions other than the operating conditions specified is not implied. Only one Absolute Maximum Rating should be applied at any one time.
2. Mounted on an FR4 board.

DATA SHEET

AAT2556

Battery Charger and Step-Down Converter for Portable Applications

Electrical Characteristics¹

$V_{IN} = 3.6V$; $T_A = -40^{\circ}C$ to $+85^{\circ}C$, unless otherwise noted. Typical values are $T_A = 25^{\circ}C$.

Symbol	Description	Conditions	Min	Typ	Max	Units
Step-Down Converter						
V_{IN}	Input Voltage		2.7		5.5	V
V_{UVLO}	UVLO Threshold	V_{IN} Rising			2.7	V
		Hysteresis		200		mV
		V_{IN} Falling	1.8			V
V_{OUT}	Output Voltage Tolerance ²	$I_{OUT} = 0$ to $250mA$, $V_{IN} = 2.7V$ to $5.5V$	-3.0		3.0	%
V_{OUT}	Output Voltage Range		0.6		V_{IN}	V
I_Q	Quiescent Current	No Load		30		μA
I_{SHDN}	Shutdown Current	EN = GND			1.0	μA
I_{LIM}	P-Channel Current Limit			600		mA
$R_{DS(ON)H}$	High-Side Switch On Resistance			0.59		Ω
$R_{DS(ON)L}$	Low-Side Switch On Resistance			0.42		Ω
I_{LXLEAK}	LX Leakage Current	$V_{IN} = 5.5V$, $V_{LX} = 0$ to V_{IN}			1.0	μA
$\frac{\Delta V_{Linereg}}{\Delta V_{IN}}$	Line Regulation	$V_{IN} = 2.7V$ to $5.5V$		0.2		%/V
V_{FB}	Feedback Threshold Voltage Accuracy	$V_{IN} = 3.6V$	0.591	0.600	0.609	V
I_{FB}	FB Leakage Current	$V_{OUT} = 1.0V$			0.2	μA
F_{OSC}	Oscillator Frequency			1.5		MHz
T_S	Startup Time	From Enable to Output Regulation		100		μs
T_{SD}	Over-Temperature Shutdown Threshold			140		$^{\circ}C$
T_{HYS}	Over-Temperature Shutdown Hysteresis			15		$^{\circ}C$
$V_{EN(L)}$	Enable Threshold Low				0.6	V
$V_{EN(H)}$	Enable Threshold High		1.4			V
I_{EN}	Input Low Current	$V_{IN} = V_{EN} = 5.5V$	-1.0		1.0	μA

1. The AAT2556 is guaranteed to meet performance specifications over the $-40^{\circ}C$ to $+85^{\circ}C$ operating temperature range and is assured by design, characterization, and correlation with statistical process controls.
2. Output voltage tolerance is independent of feedback resistor network accuracy.

Battery Charger and Step-Down Converter for Portable Applications

Electrical Characteristics¹

$V_{ADP} = 5V$; $T_A = -40^{\circ}C$ to $+85^{\circ}C$, unless otherwise noted. Typical values are $T_A = 25^{\circ}C$.

Symbol	Description	Conditions	Min	Typ	Max	Units
Battery Charger						
Operation						
V_{ADP}	Adapter Voltage Range		4.0		6.5	V
V_{UVLO}	Under-Voltage Lockout (UVLO)	Rising Edge	3		4	V
	UVLO Hysteresis			150		mV
I_{OP}	Operating Current	Charge Current = 200mA		0.5	1	mA
$I_{SHUTDOWN}$	Shutdown Current	$V_{BAT} = 4.25V$, EN = GND		0.3	1	μA
$I_{LEAKAGE}$	Reverse Leakage Current from BAT Pin	$V_{BAT} = 4V$, ADP Pin Open		0.4	2	μA
Voltage Regulation						
V_{BAT_EOC}	End of Charge Accuracy		4.158	4.20	4.242	V
$\Delta V_{CH}/V_{CH}$	Output Charge Voltage Tolerance			0.5		%
V_{MIN}	Preconditioning Voltage Threshold		2.85	3.0	3.15	V
V_{RCH}	Battery Recharge Voltage Threshold	Measured from V_{BAT_EOC}		-0.1		V
Current Regulation						
I_{CH}	Charge Current Programmable Range		15		500	mA
$\Delta I_{CH}/I_{CH}$	Charge Current Regulation Tolerance			10		%
V_{SET}	ISET Pin Voltage			2		V
K_{I_A}	Current Set Factor: I_{CH}/I_{SET}			800		
Charging Devices						
$R_{DS(ON)}$	Charging Transistor On Resistance	$V_{ADP} = 5.5V$		0.9	1.1	Ω
Logic Control/Protection						
$V_{EN(H)}$	Input High Threshold		1.6			V
$V_{EN(L)}$	Input Low Threshold				0.4	V
V_{STAT}	Output Low Voltage	STAT Pin Sinks 4mA			0.4	V
I_{STAT}	STAT Pin Current Sink Capability				8	mA
V_{OVP}	Over-Voltage Protection Threshold			4.4		V
I_{TR}/I_{CHG}	Pre-Charge Current	$I_{CH} = 100mA$		10		%
I_{TERM}/I_{CHG}	Charge Termination Threshold Current			10		%

1. The AAT2556 output charge voltage is specified over the 0° to 70°C ambient temperature range; operation over the -25°C to +85°C temperature range is guaranteed by design.

Battery Charger and Step-Down Converter for Portable Applications

Typical Characteristics – Step-Down Converter

Efficiency vs. Load
($V_{OUT} = 1.8V$; $L = 3.3\mu H$)

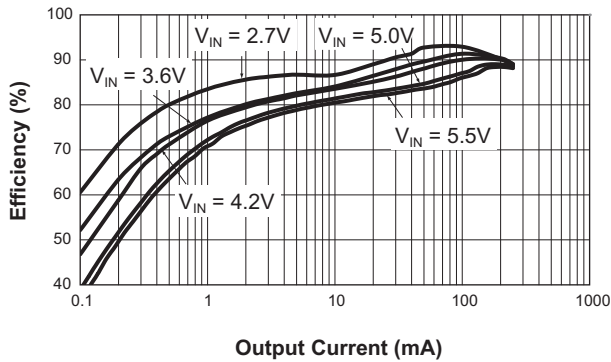

DC Load Regulation
($V_{OUT} = 1.8V$; $L = 3.3\mu H$)

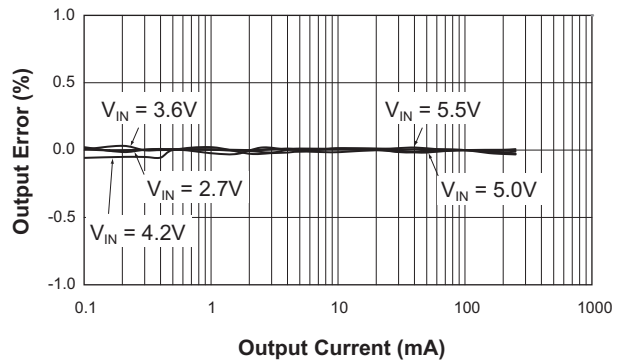

Efficiency vs. Load
($V_{OUT} = 1.2V$; $L = 1.5\mu H$)

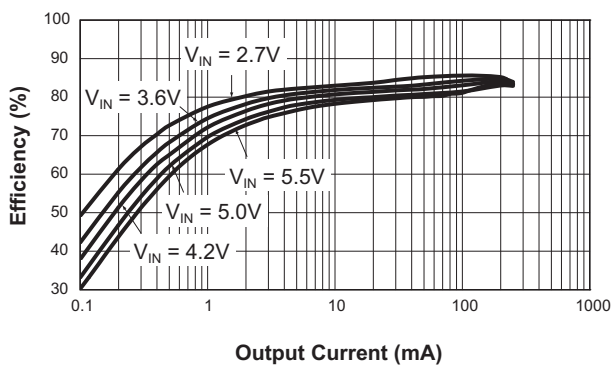

DC Load Regulation
($V_{OUT} = 1.2V$; $L = 1.5\mu H$)

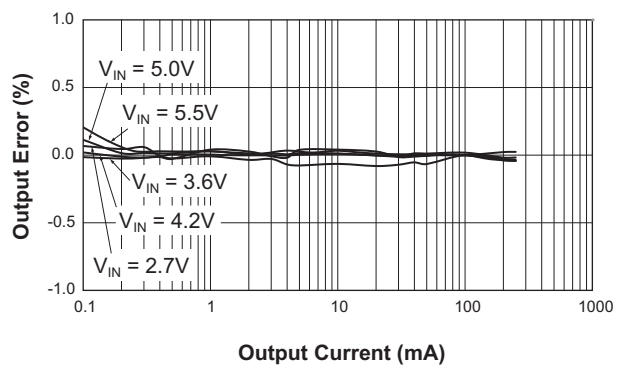

Soft Start
($V_{IN} = 3.6V$; $V_{OUT} = 1.8V$;
 $I_{OUT} = 250mA$; $C_{FF} = 100pF$)

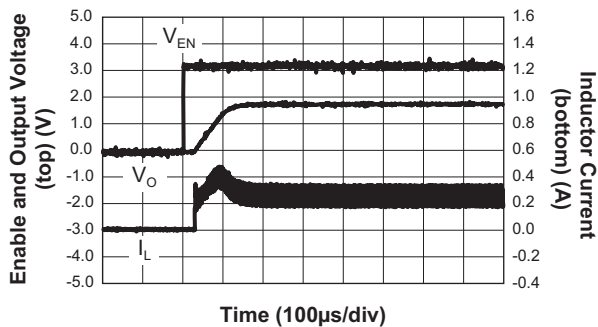

Line Regulation
($V_{OUT} = 1.8V$)

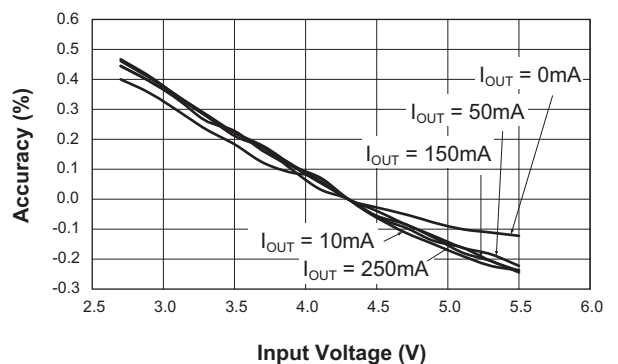

Battery Charger and Step-Down Converter for Portable Applications

Typical Characteristics – Step-Down Converter

Output Voltage Error vs. Temperature

($V_{IN} = 3.6V$; $V_{OUT} = 1.8V$; $I_{OUT} = 250mA$)

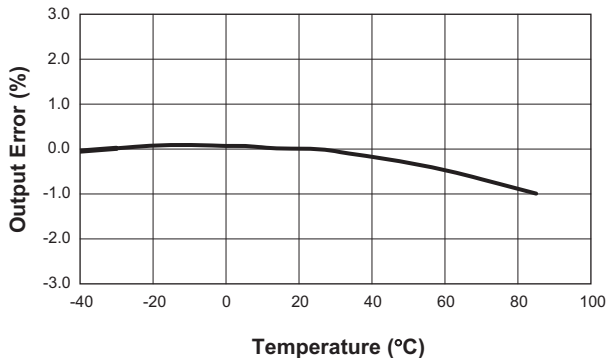

Switching Frequency Variation vs. Temperature

($V_{IN} = 3.6V$; $V_{OUT} = 1.8V$)

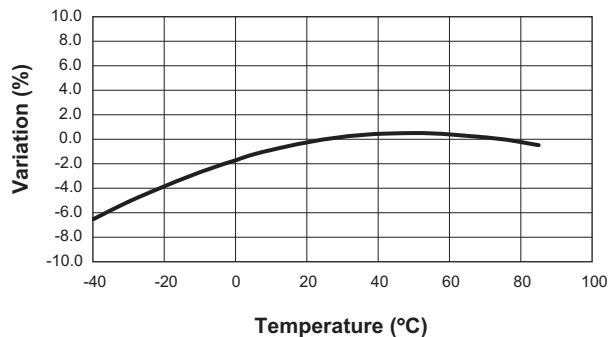

Frequency Variation vs. Input Voltage

($V_{OUT} = 1.8V$)

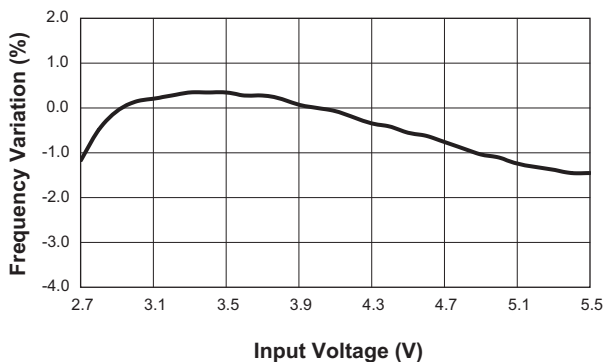

No Load Quiescent Current vs. Input Voltage

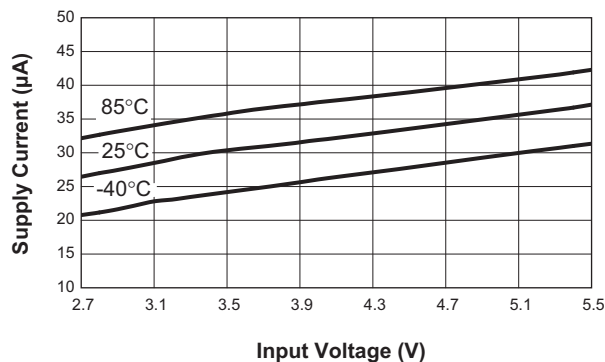

P-Channel $R_{DS(ON)}$ vs. Input Voltage

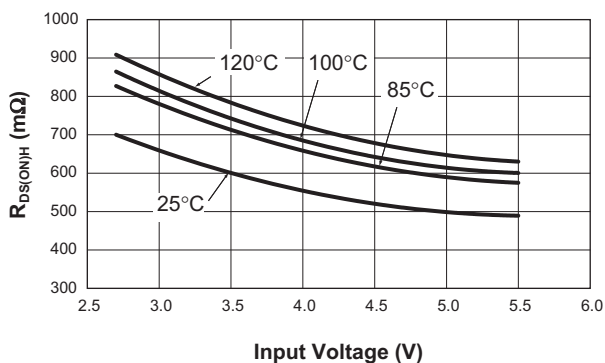

N-Channel $R_{DS(ON)}$ vs. Input Voltage

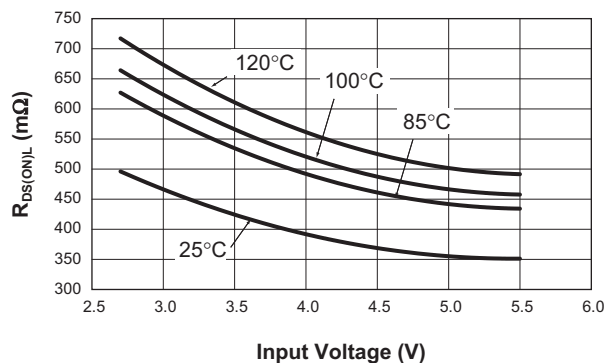

Battery Charger and Step-Down Converter for Portable Applications

Typical Characteristics – Step-Down Converter

Load Transient Response
 (10mA to 250mA; $V_{IN} = 3.6V$; $V_{OUT} = 1.8V$;
 $C_{OUT} = 4.7\mu F$; $C_{FF} = 100pF$)

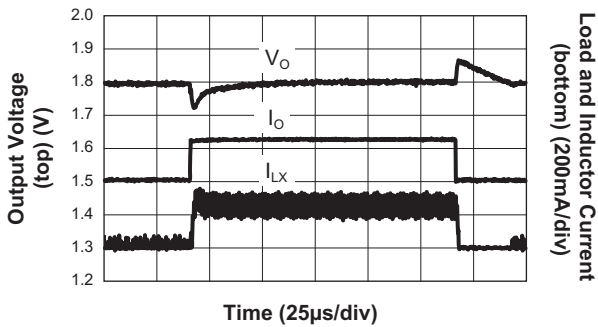

Load Transient Response
 (10mA to 250mA; $V_{IN} = 3.6V$; $V_{OUT} = 1.8V$; $C_{OUT} = 4.7\mu F$)

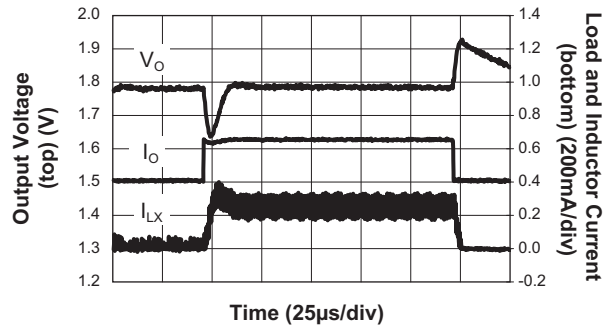

Line Response
 ($V_{OUT} = 1.8V$ @ 250mA; $C_{FF} = 100pF$)

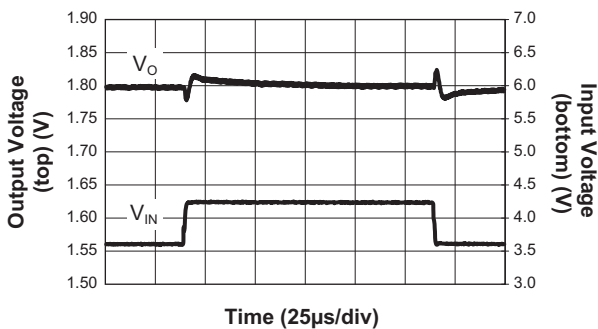

Output Ripple
 ($V_{IN} = 3.6V$; $V_{OUT} = 1.8V$; $I_{OUT} = 1mA$)

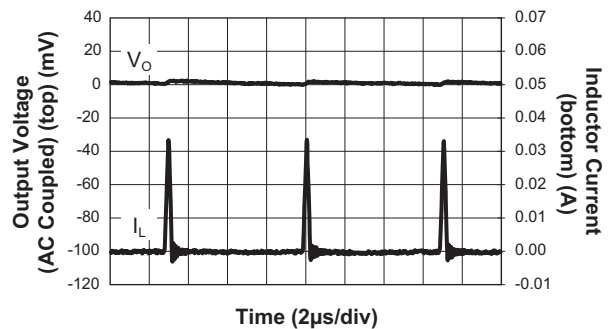

Output Ripple
 ($V_{IN} = 3.6V$; $V_{OUT} = 1.8V$; $I_{OUT} = 250mA$)

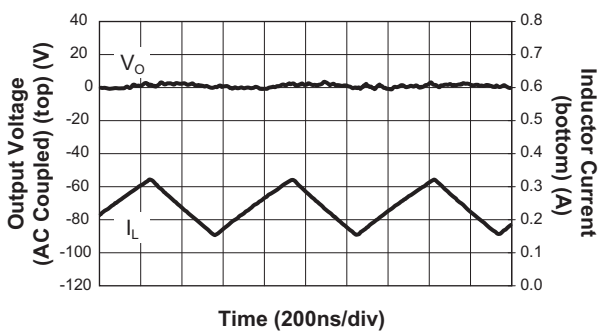

Battery Charger and Step-Down Converter for Portable Applications

Typical Characteristics – Battery Charger

Constant Charging Current vs. Set Resistor Values

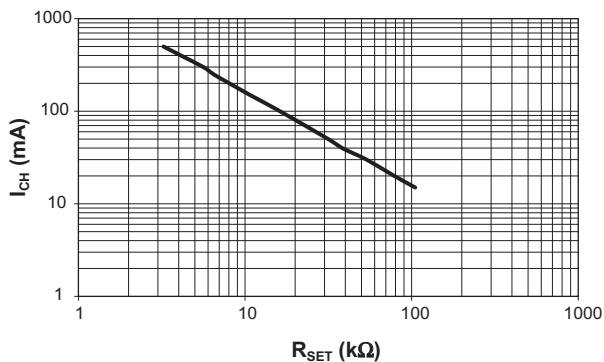

Charging Current vs. Battery Voltage
($V_{ADP} = 5V$)

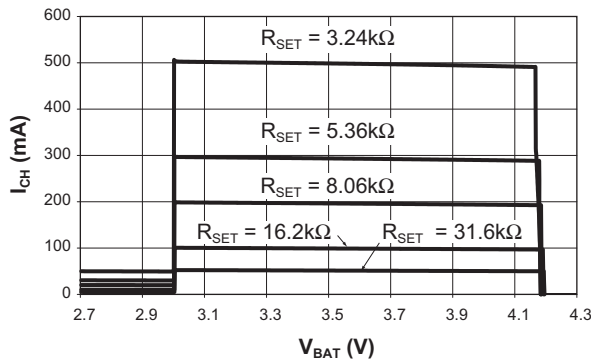

End of Charge Battery Voltage vs. Supply Voltage

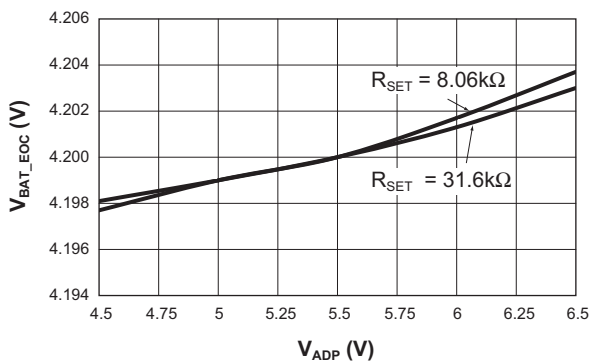

End of Charge Voltage Regulation vs. Temperature
($R_{SET} = 8.06k\Omega$)

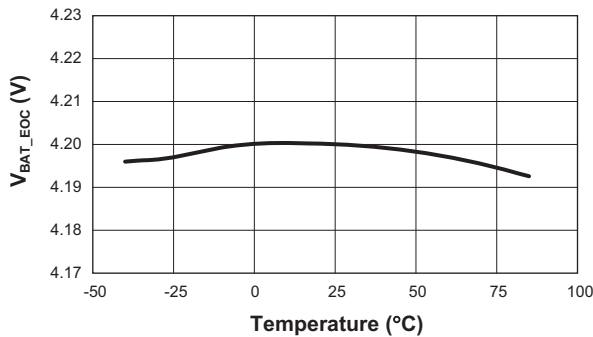

Constant Charging Current vs. Supply Voltage
($R_{SET} = 8.06k\Omega$)

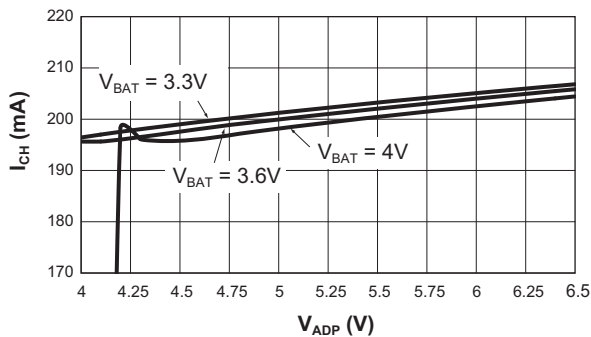

Constant Charging Current vs. Temperature
($R_{SET} = 8.06k\Omega$)

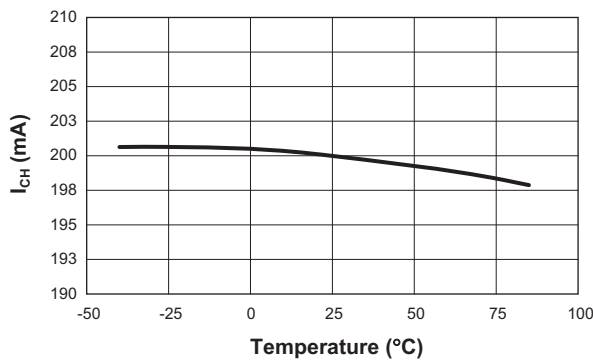

Battery Charger and Step-Down Converter for Portable Applications

Typical Characteristics – Battery Charger

Operating Current vs. Temperature
($R_{SET} = 8.06k\Omega$)

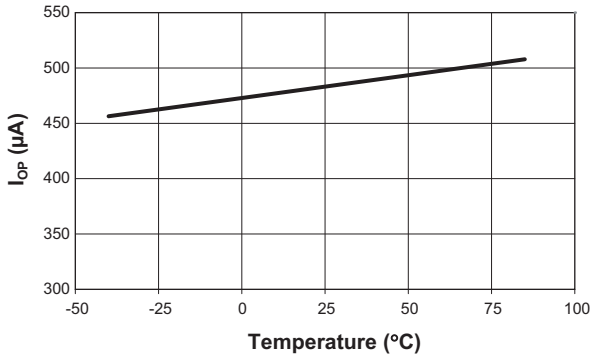

Preconditioning Threshold Voltage vs. Temperature
($R_{SET} = 8.06k\Omega$)

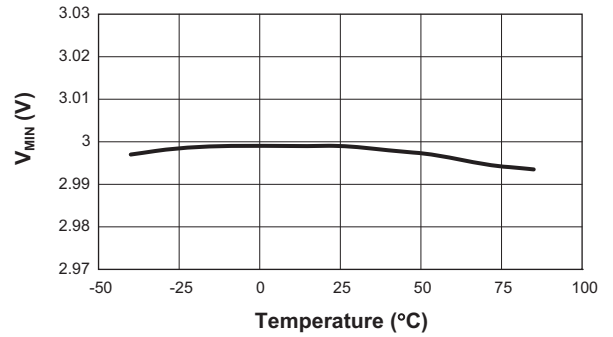

Preconditioning Charge Current vs. Temperature
($R_{SET} = 8.06k\Omega$)

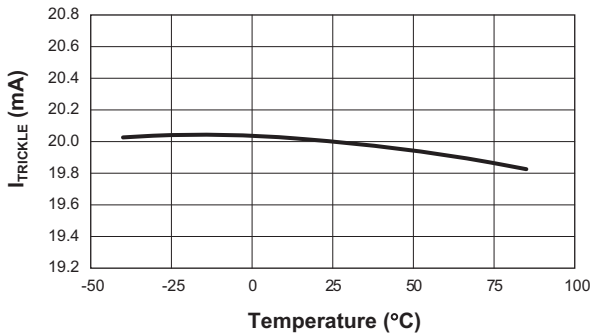

Preconditioning Charge Current vs. Supply Voltage

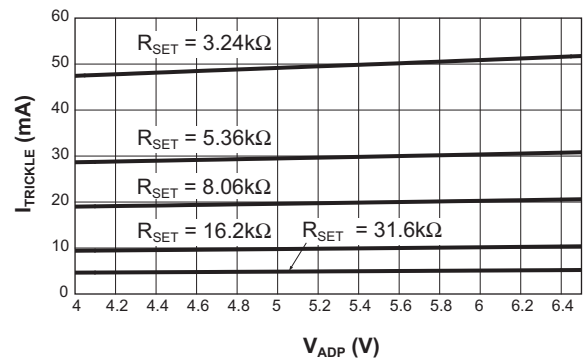

Recharging Threshold Voltage vs. Temperature
($R_{SET} = 8.06k\Omega$)

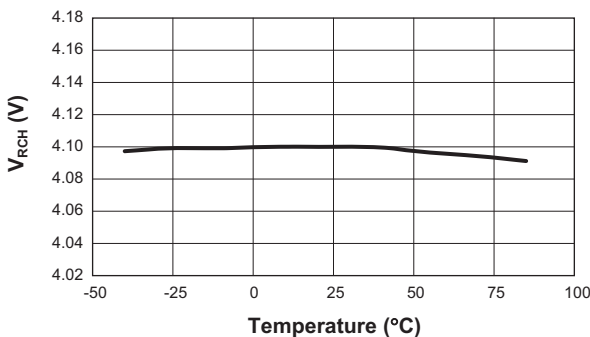

Sleep Mode Current vs. Supply Voltage
($R_{SET} = 8.06k\Omega$)

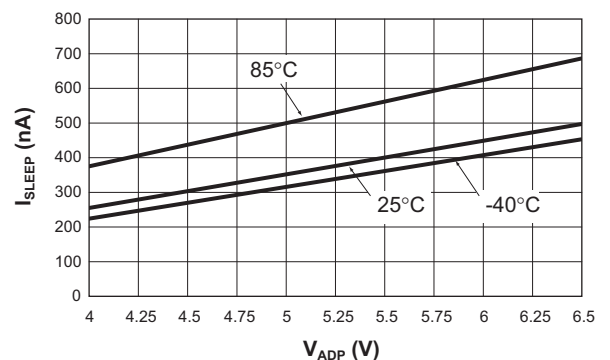

Battery Charger and Step-Down Converter for Portable Applications

Typical Characteristics – Battery Charger

$V_{EN(H)}$ vs. Supply Voltage
($R_{SET} = 8.06k\Omega$)

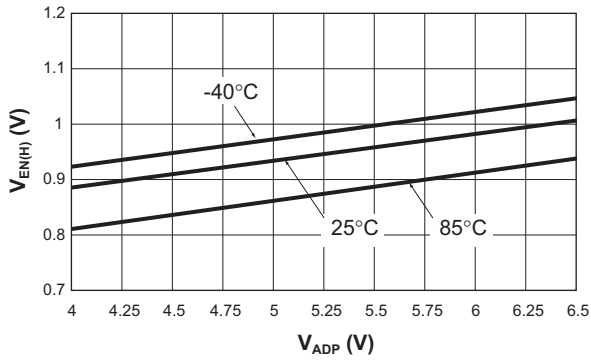

$V_{EN(L)}$ vs. Supply Voltage
($R_{SET} = 8.06k\Omega$)

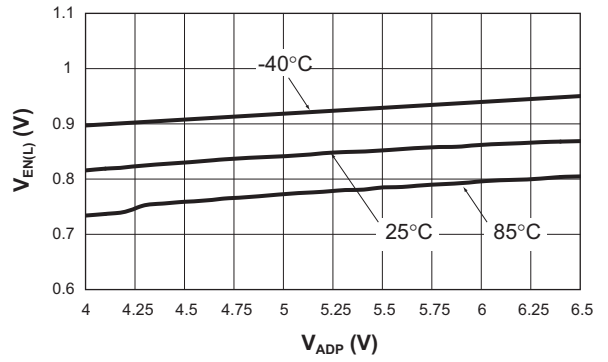

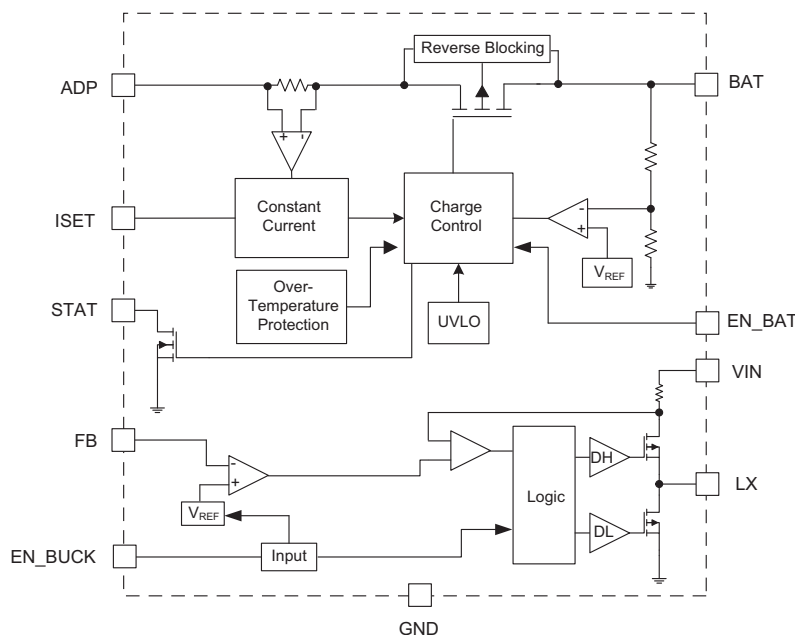
Battery Charger and Step-Down Converter for Portable Applications**Functional Block Diagram****Functional Description**

The AAT2556 is a high performance power system comprised of a 500mA lithium-ion/polymer battery charger and a 250mA step-down converter.

The battery charger is designed for single-cell lithium-ion/polymer batteries using a constant current and constant voltage algorithm. The battery charger operates from the adapter/USB input voltage range from 4V to 6.5V. The adapter/USB charging current level can be programmed up to 500mA for rapid charging applications. A status monitor output pin is provided to indicate the battery charge state by directly driving one external LED. Internal device temperature and charging state are fully monitored for fault conditions. In the event of an over-voltage or over-temperature failure, the device will automatically shut down, protecting the charging device, control system, and the battery under charge. Other features include an integrated reverse blocking diode and sense resistor.

The step-down converter operates with an input voltage of 2.7V to 5.5V. The switching frequency is 1.5MHz, minimizing the size of the inductor. Under light load conditions, the device enters power-saving mode; the switching frequency is reduced, and the converter consumes 30 μ A of current, making it ideal for battery-operated applications. The output voltage is programmable from V_{IN} to as low as 0.6V. Power devices are sized for

250mA current capability while maintaining over 90% efficiency at full load. Light load efficiency is maintained at greater than 80% down to 1mA of load current. A high-DC gain error amplifier with internal compensation controls the output. It provides excellent transient response and load/line regulation.

Under-Voltage Lockout

The AAT2556 has internal circuits for UVLO and power on reset features. If the ADP supply voltage drops below the UVLO threshold, the battery charger will suspend charging and shut down. When power is reapplied to the ADP pin or the UVLO condition recovers, the system charge control will automatically resume charging in the appropriate mode for the condition of the battery. If the input voltage of the step-down converter drops below UVLO, the internal circuit will shut down.

Protection Circuitry**Over-Voltage Protection**

An over-voltage protection event is defined as a condition where the voltage on the BAT pin exceeds the over-voltage protection threshold (V_{OVP}). If this over-voltage condition occurs, the charger control circuitry will shut down the device. The charger will resume normal charging operation after the over-voltage condition is removed.

Battery Charger and Step-Down Converter for Portable Applications

Current Limit, Over-Temperature Protection

For overload conditions, the peak input current is limited at the step-down converter. As load impedance decreases and the output voltage falls closer to zero, more power is dissipated internally, which causes the internal die temperature to rise. In this case, the thermal protection circuit completely disables switching, which protects the device from damage.

The battery charger has a thermal protection circuit which will shut down charging functions when the internal die temperature exceeds the preset thermal limit threshold. Once the internal die temperature falls below the thermal limit, normal charging operation will resume.

Control Loop

The AAT2556 contains a compact, current mode step-down DC/DC controller. The current through the P-channel MOSFET (high side) is sensed for current loop control, as well as short-circuit and overload protection. A fixed slope compensation signal is added to the sensed current to maintain stability for duty cycles greater than 50%. The peak current mode loop appears as a voltage-programmed current source in parallel with the output capacitor. The output of the voltage error amplifier programs the current mode loop for the necessary peak switch current to force a constant output voltage for all load and line conditions. Internal loop compensation terminates the transconductance voltage error amplifier output. The error amplifier reference is fixed at 0.6V.

Battery Charging Operation

Battery charging commences only after checking several conditions in order to maintain a safe charging environment. The input supply (ADP) must be above the minimum operating voltage (UVLO) and the enable pin must be high (internally pulled down). When the battery is

connected to the BAT pin, the charger checks the condition of the battery and determines which charging mode to apply. If the battery voltage is below V_{MIN} , the charger begins battery pre-conditioning by charging at 10% of the programmed constant current; e.g., if the programmed current is 150mA, then the pre-conditioning current (trickle charge) is 15mA. Pre-conditioning is purely a safety precaution for a deeply discharged cell and will also reduce the power dissipation in the internal series pass MOSFET when the input-output voltage differential is at its highest.

Pre-conditioning continues until the battery voltage reaches V_{MIN} . At this point, the charger begins constant-current charging. The current level for this mode is programmed using a single resistor from the ISET pin to ground. Programmed current can be set from a minimum 15mA up to a maximum of 500mA. Constant current charging will continue until the battery voltage reaches the voltage regulation point, V_{BAT} . When the battery voltage reaches V_{BAT} , the battery charger begins constant voltage mode. The regulation voltage is factory programmed to a nominal 4.2V ($\pm 0.5\%$) and will continue charging until the charging current has reduced to 10% of the programmed current.

After the charge cycle is complete, the pass device turns off and the device automatically goes into a power-saving sleep mode. During this time, the series pass device will block current in both directions, preventing the battery from discharging through the IC.

The battery charger will remain in sleep mode, even if the charger source is disconnected, until one of the following events occurs: the battery terminal voltage drops below the V_{RCH} threshold; the charger EN pin is recycled; or the charging source is reconnected. In all cases, the charger will monitor all parameters and resume charging in the most appropriate mode.

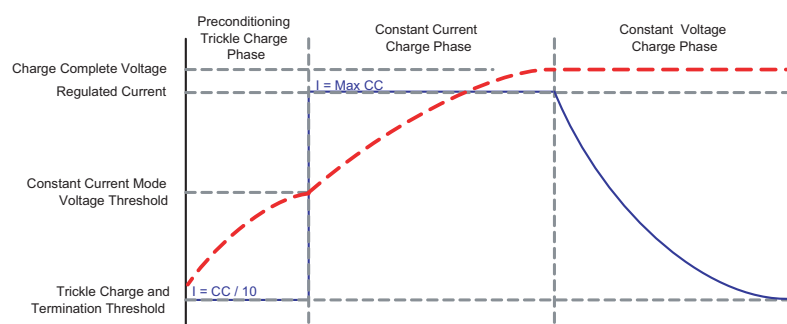
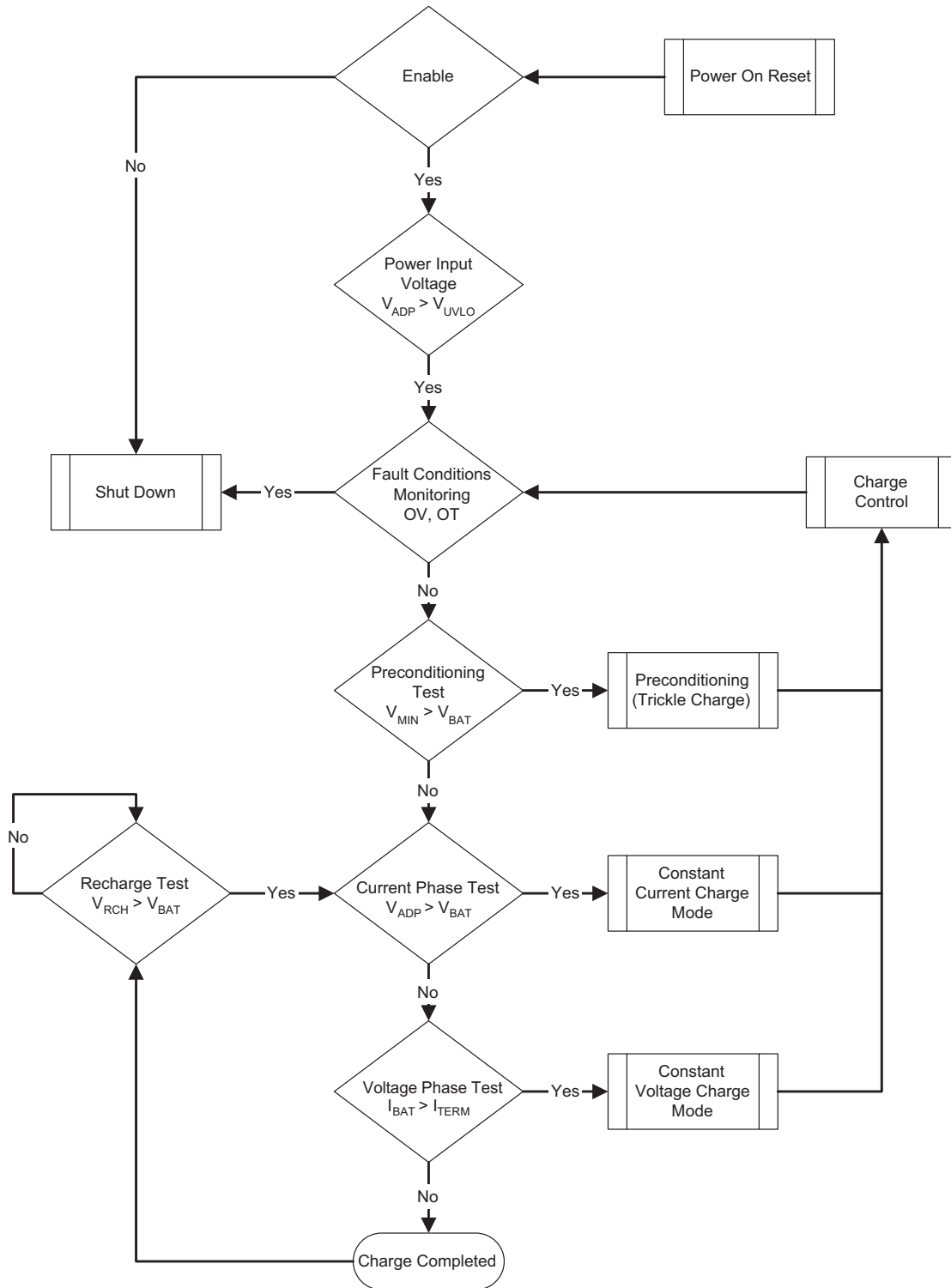

Figure 1: Current vs. Voltage Profile During Charging Phases.

Battery Charger and Step-Down Converter for Portable Applications

Battery Charging System Operation Flow Chart



Battery Charger and Step-Down Converter for Portable Applications

Application Information

Soft Start / Enable

The EN_BAT pin is internally pulled down. When pulled to a logic high level, the battery charger is enabled. When left open or pulled to a logic low level, the battery charger is shut down and forced into the sleep state. Charging will be halted regardless of the battery voltage or charging state. When it is re-enabled, the charge control circuit will automatically reset and resume charging functions with the appropriate charging mode based on the battery charge state and measured cell voltage from the BAT pin.

The step-down converter features a soft start that limits the inrush current and eliminates output voltage overshoot during startup. The circuit is designed to increase the inductor current limit in discrete steps when the input voltage or enable input is applied. Typical start up time is 100µs.

Pulling EN_BUCK to logic low forces the converter in a low power, non-switching state, and it consumes less than 1µA of quiescent current. Connecting it to logic high enables the converter and resumes normal operation.

Adapter or USB Power Input

Constant current charge levels up to 500mA may be programmed by the user when powered from a sufficient input power source. The battery charger will operate from the adapter input over a 4.0V to 6.5V range. The constant current fast charge current for the adapter input is set by the R_{SET} resistor connected between ISET and ground. Refer to Table 1 for recommended R_{SET} values for a desired constant current charge level.

Programming Charge Current

The fast charge constant current charge level is user programmed with a set resistor placed between the ISET pin and ground. The accuracy of the fast charge, as well as the preconditioning trickle charge current, is dominated by the tolerance of the set resistor used. For this reason, a 1% tolerance metal film resistor is recommended for the set resistor function. Fast charge constant current levels from 15mA to 500mA may be set by selecting the appropriate resistor value from Table 1.

Normal I _{CHARGE} (mA)	Set Resistor Value R ₂ (kΩ)
500	3.24
400	4.12
300	5.36
250	6.49
200	8.06
150	10.7
100	16.2
50	31.6
40	38.3
30	53.6
20	78.7
15	105

Table 1: R_{SET} Values.

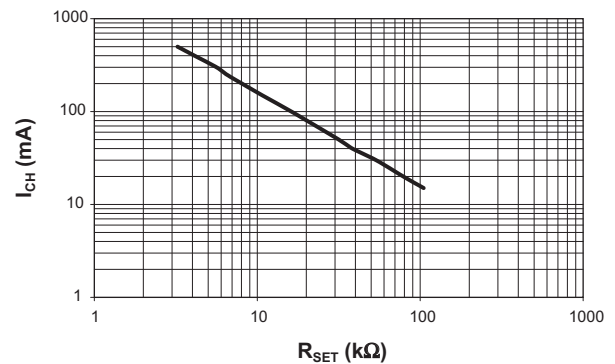

Figure 2: Constant Charging Current vs. Set Resistor Values.

Charge Status Output

The AAT2556 provides battery charge status via a status pin. This pin is internally connected to an N-channel open drain MOSFET, which can be used to drive an external LED. The status pin can indicate several conditions, as shown in Table 2.

Event Description	Status
No battery charging activity	OFF
Battery charging via adapter or USB port	ON
Charging completed	OFF

Table 2: LED Status Indicator.

Battery Charger and Step-Down Converter for Portable Applications

The LED should be biased with as little current as necessary to create reasonable illumination; therefore, a ballast resistor should be placed between the LED cathode and the STAT pin. LED current consumption will add to the overall thermal power budget for the device package, hence it is good to keep the LED drive current to a minimum. 2mA should be sufficient to drive most low-cost green or red LEDs. It is not recommended to exceed 8mA for driving an individual status LED.

The required ballast resistor values can be estimated using the following formulas:

$$R_1 = \frac{V_{ADP} - V_{F(LED)}}{I_{LED}}$$

Example:

$$R_1 = \frac{5.5V - 2.0V}{2mA} = 1.75k\Omega$$

Note: Red LED forward voltage (V_F) is typically 2.0V @ 2mA.

Thermal Considerations

The AAT2556 is offered in a TDFN33-12 package which can provide up to 2W of power dissipation when it is properly bonded to a printed circuit board and has a maximum thermal resistance of 50°C/W. Many considerations should be taken into account when designing the printed circuit board layout, as well as the placement of the charger IC package in proximity to other heat generating devices in a given application design. The ambient temperature around the IC will also have an effect on the thermal limits of a battery charging application. The maximum limits that can be expected for a given ambient condition can be estimated by the following discussion.

First, the maximum power dissipation for a given situation should be calculated:

$$P_{D(MAX)} = \frac{(T_{J(MAX)} - T_A)}{\theta_{JA}}$$

Where:

- $P_{D(MAX)}$ = Maximum Power Dissipation (W)
- θ_{JA} = Package Thermal Resistance (°C/W)
- $T_{J(MAX)}$ = Maximum Device Junction Temperature (°C)
[135°C]
- T_A = Ambient Temperature (°C)

Figure 3 shows the relationship of maximum power dissipation and ambient temperature of the AAT2556.

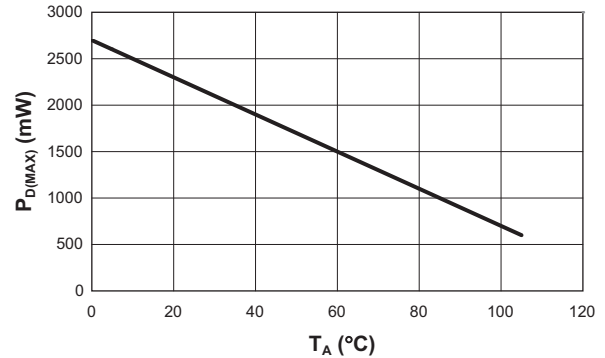

Figure 3: Maximum Power Dissipation.

Next, the power dissipation of the battery charger can be calculated by the following equation:

$$P_D = [(V_{ADP} - V_{BAT}) \cdot I_{CH} + (V_{ADP} \cdot I_{OP})]$$

Where:

- P_D = Total Power Dissipation by the Device
- V_{ADP} = ADP/USB Voltage
- V_{BAT} = Battery Voltage as Seen at the BAT Pin
- I_{CH} = -Constant Charge Current Programmed for the Application
- I_{OP} = -Quiescent Current Consumed by the Charger IC for Normal Operation [0.5mA]

By substitution, we can derive the maximum charge current before reaching the thermal limit condition (thermal cycling). The maximum charge current is the key factor when designing battery charger applications.

$$I_{CH(MAX)} = \frac{(P_{D(MAX)} - V_{IN} \cdot I_{OP})}{V_{IN} - V_{BAT}}$$

$$I_{CH(MAX)} = \frac{\frac{(T_{J(MAX)} - T_A)}{\theta_{JA}} - V_{IN} \cdot I_{OP}}{V_{IN} - V_{BAT}}$$

In general, the worst condition is the greatest voltage drop across the IC, when battery voltage is charged up to the preconditioning voltage threshold. Figure 4 shows the maximum charge current in different ambient temperatures.

Battery Charger and Step-Down Converter for Portable Applications

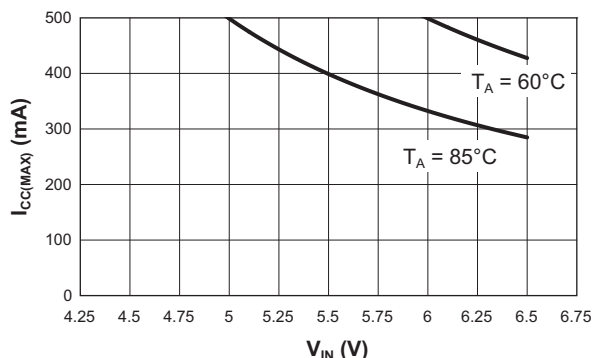

Figure 4: Maximum Charging Current Before Thermal Cycling Becomes Active.

There are three types of losses associated with the step-down converter: switching losses, conduction losses, and quiescent current losses. Conduction losses are associated with the $R_{DS(ON)}$ characteristics of the power output switching devices. Switching losses are dominated by the gate charge of the power output switching devices. At full load, assuming continuous conduction mode (CCM), a simplified form of the losses is given by:

$$P_{TOTAL} = \frac{I_O^2 \cdot (R_{DS(ON)(H)} \cdot V_O + R_{DS(ON)(L)} \cdot [V_{IN} - V_O])}{V_{IN}} + (t_{sw} \cdot F_S \cdot I_O + I_Q) \cdot V_{IN}$$

I_Q is the step-down converter quiescent current. The term t_{sw} is used to estimate the full load step-down converter switching losses.

For the condition where the step-down converter is in dropout at 100% duty cycle, the total device dissipation reduces to:

$$P_{TOTAL} = I_O^2 \cdot R_{DS(ON)(H)} + I_Q \cdot V_{IN}$$

Since $R_{DS(ON)}$, quiescent current, and switching losses all vary with input voltage, the total losses should be investigated over the complete input voltage range.

Given the total losses, the maximum junction temperature can be derived from the θ_{JA} for the TDFN33-12 package which is 50°C/W.

$$T_{J(MAX)} = P_{TOTAL} \cdot \theta_{JA} + T_{AMB}$$

Capacitor Selection

Battery Charger Input Capacitor (C1)

In general, it is good design practice to place a decoupling capacitor between the ADP pin and GND. An input capacitor in the range of 1 μ F to 22 μ F is recommended. If the source supply is unregulated, it may be necessary to increase the capacitance to keep the input voltage above the under-voltage lockout threshold during device enable and when battery charging is initiated. If the adapter input is to be used in a system with an external power supply source, such as a typical AC-to-DC wall adapter, then a C_{IN} capacitor in the range of 10 μ F should be used. A larger input capacitor in this application will minimize switching or power transient effects when the power supply is "hot plugged" in.

Step-Down Converter Input Capacitor (C3)

Select a 4.7 μ F to 10 μ F X7R or X5R ceramic capacitor for the input. To estimate the required input capacitor size, determine the acceptable input ripple level (V_{PP}) and solve for C_{IN} . The calculated value varies with input voltage and is a maximum when V_{IN} is double the output voltage.

$$C_{IN} = \frac{\frac{V_O}{V_{IN}} \cdot \left(1 - \frac{V_O}{V_{IN}}\right)}{\left(\frac{V_{PP}}{I_O} - ESR\right) \cdot F_S}$$

$$\frac{V_O}{V_{IN}} \cdot \left(1 - \frac{V_O}{V_{IN}}\right) = \frac{1}{4} \text{ for } V_{IN} = 2 \cdot V_O$$

$$C_{IN(MIN)} = \frac{1}{\left(\frac{V_{PP}}{I_O} - ESR\right) \cdot 4 \cdot F_S}$$

Always examine the ceramic capacitor DC voltage coefficient characteristics when selecting the proper value. For example, the capacitance of a 10 μ F, 6.3V, X5R ceramic capacitor with 5.0V DC applied is actually about 6 μ F.

The maximum input capacitor RMS current is:

$$\sqrt{\frac{V_O}{V_{IN}} \cdot \left(1 - \frac{V_O}{V_{IN}}\right)} = \sqrt{D \cdot (1 - D)} = \sqrt{0.5^2} = \frac{1}{2}$$

Battery Charger and Step-Down Converter for Portable Applications

The input capacitor RMS ripple current varies with the input and output voltage and will always be less than or equal to half of the total DC load current.

$$I_{\text{RMS}} = I_{\text{O}} \cdot \sqrt{\frac{V_{\text{O}}}{V_{\text{IN}}} \cdot \left(1 - \frac{V_{\text{O}}}{V_{\text{IN}}}\right)}$$

for $V_{\text{IN}} = 2 \cdot V_{\text{O}}$

$$I_{\text{RMS(MAX)}} = \frac{I_{\text{O}}}{2}$$

The term $\frac{V_{\text{O}}}{V_{\text{IN}}} \cdot \left(1 - \frac{V_{\text{O}}}{V_{\text{IN}}}\right)$ appears in both the input voltage ripple and input capacitor RMS current equations and is a maximum when V_{O} is twice V_{IN} . This is why the input voltage ripple and the input capacitor RMS current ripple are a maximum at 50% duty cycle.

The input capacitor provides a low impedance loop for the edges of pulsed current drawn by the step-down converter. Low ESR/ESL X7R and X5R ceramic capacitors are ideal for this function. To minimize stray inductance, the capacitor should be placed as closely as possible to the IC. This keeps the high frequency content of the input current localized, minimizing EMI and input voltage ripple.

The proper placement of the input capacitor (C3) can be seen in the evaluation board layout in Figure 6.

A laboratory test set-up typically consists of two long wires running from the bench power supply to the evaluation board input voltage pins. The inductance of these wires, along with the low-ESR ceramic input capacitor, can create a high Q network that may affect converter performance. This problem often becomes apparent in the form of excessive ringing in the output voltage during load transients. Errors in the loop phase and gain measurements can also result.

Since the inductance of a short PCB trace feeding the input voltage is significantly lower than the power leads from the bench power supply, most applications do not exhibit this problem.

In applications where the input power source lead inductance cannot be reduced to a level that does not affect the converter performance, a high ESR tantalum or aluminum electrolytic capacitor should be placed in parallel with the low ESR, ESL bypass ceramic capacitor. This dampens the high Q network and stabilizes the system.

Battery Charger Output Capacitor (C2)

The AAT2556 only requires a 1 μ F ceramic capacitor on the BAT pin to maintain circuit stability. This value should

be increased to 10 μ F or more if the battery connection is made any distance from the charger output. If the AAT2556 is to be used in applications where the battery can be removed from the charger, such as with desktop charging cradles, an output capacitor greater than 10 μ F may be required to prevent the device from cycling on and off when no battery is present.

Step-Down Converter Output Capacitor (C4)

The output capacitor limits the output ripple and provides holdup during large load transitions. A 4.7 μ F to 10 μ F X5R or X7R ceramic capacitor typically provides sufficient bulk capacitance to stabilize the output during large load transitions and has the ESR and ESL characteristics necessary for low output ripple. For enhanced transient response and low temperature operation applications, a 10 μ F (X5R, X7R) ceramic capacitor is recommended to stabilize extreme pulsed load conditions.

The output voltage droop due to a load transient is dominated by the capacitance of the ceramic output capacitor. During a step increase in load current, the ceramic output capacitor alone supplies the load current until the loop responds. Within two or three switching cycles, the loop responds and the inductor current increases to match the load current demand. The relationship of the output voltage droop during the three switching cycles to the output capacitance can be estimated by:

$$C_{\text{OUT}} = \frac{3 \cdot \Delta I_{\text{LOAD}}}{V_{\text{DROOP}} \cdot F_{\text{S}}}$$

Once the average inductor current increases to the DC load level, the output voltage recovers. The above equation establishes a limit on the minimum value for the output capacitor with respect to load transients.

The internal voltage loop compensation also limits the minimum output capacitor value to 4.7 μ F. This is due to its effect on the loop crossover frequency (bandwidth), phase margin, and gain margin. Increased output capacitance will reduce the crossover frequency with greater phase margin.

The maximum output capacitor RMS ripple current is given by:

$$I_{\text{RMS(MAX)}} = \frac{1}{2 \cdot \sqrt{3}} \cdot \frac{V_{\text{OUT}} \cdot (V_{\text{IN(MAX)}} - V_{\text{OUT}})}{L \cdot F_{\text{S}} \cdot V_{\text{IN(MAX)}}$$

Dissipation due to the RMS current in the ceramic output capacitor ESR is typically minimal, resulting in less than a few degrees rise in hot-spot temperature.

Battery Charger and Step-Down Converter for Portable Applications

Inductor Selection

The step-down converter uses peak current mode control with slope compensation to maintain stability for duty cycles greater than 50%. The output inductor value must be selected so the inductor current down slope meets the internal slope compensation requirements. The internal slope compensation for the AAT2556 is 0.45A/μsec. This equates to a slope compensation that is 75% of the inductor current down slope for a 1.8V output and 3.0μH inductor.

$$m = \frac{0.75 \cdot V_o}{L} = \frac{0.75 \cdot 1.8V}{3.0\mu H} = 0.45 \frac{A}{\mu sec}$$

$$L = \frac{0.75 \cdot V_o}{m} = \frac{0.75 \cdot V_o}{0.45A \frac{A}{\mu sec}} \approx 1.67 \frac{\mu sec}{A} \cdot V_o$$

$$= 1.67 \frac{\mu sec}{A} \cdot 3.0V = 5.0\mu H$$

For most designs, the step-down converter operates with an inductor value of 1μH to 4.7μH. Table 3 displays inductor values for the AAT2556 with different output voltage options.

Manufacturer's specifications list both the inductor DC current rating, which is a thermal limitation, and the peak current rating, which is determined by the saturation characteristics. The inductor should not show any appreciable saturation under normal load conditions. Some inductors may meet the peak and average current ratings yet result in excessive losses due to a high DCR. Always consider the losses associated with the DCR and its effect on the total converter efficiency when selecting an inductor.

The 3.0μH CDRH2D09 series inductor selected from Sumida has a 150mΩ DCR and a 470mA DC current rating. At full load, the inductor DC loss is 9.375mW which gives a 2.08% loss in efficiency for a 250mA, 1.8V output.

Output Voltage (V)	L1 (μH)
1.0	1.5
1.2	2.2
1.5	2.7
1.8	3.0/3.3
2.5	3.9/4.2
3.0	4.7
3.3	5.6

Table 3: Inductor Values.

Adjustable Output Resistor Selection

Resistors R3 and R4 of Figure 5 program the output to regulate at a voltage higher than 0.6V. To limit the bias current required for the external feedback resistor string while maintaining good noise immunity, the suggested value for R4 is 59kΩ. Decreased resistor values are necessary to maintain noise immunity on the FB pin, resulting in increased quiescent current. Table 4 summarizes the resistor values for various output voltages.

$$R3 = \left(\frac{V_{OUT}}{V_{REF}} - 1 \right) \cdot R4 = \left(\frac{3.3V}{0.6V} - 1 \right) \cdot 59k\Omega = 267k\Omega$$

With enhanced transient response for extreme pulsed load application, an external feed-forward capacitor (C5 in Figure 5) can be added.

V _{OUT} (V)	R4 = 59kΩ	R4 = 221kΩ
	R3 (kΩ)	R3 (kΩ)
0.8	19.6	75
0.9	29.4	113
1.0	39.2	150
1.1	49.9	187
1.2	59.0	221
1.3	68.1	261
1.4	78.7	301
1.5	88.7	332
1.8	118	442
1.85	124	464
2.0	137	523
2.5	187	715
3.3	267	1000

Table 4: Adjustable Resistor Values For Step-Down Converter.

Battery Charger and Step-Down Converter for Portable Applications**Printed Circuit Board
Layout Considerations**

For the best results, it is recommended to physically place the battery pack as close as possible to the AAT2556 BAT pin. To minimize voltage drops on the PCB, keep the high current carrying traces adequately wide. Refer to the AAT2556 evaluation board for a good layout example (see Figures 6 and 7). The following guidelines should be used to help ensure a proper layout.

1. The input capacitors (C1, C3) should connect as closely as possible to ADP (Pin 9) and VIN (Pin 12).
2. C4 and L1 should be connected as closely as possible. The connection of L1 to the LX pin should be as short as possible. Do not make the node small by using narrow trace. The trace should be kept wide, direct, and short.
3. The feedback pin (Pin 1) should be separate from any power trace and connect as closely as possible to the load point. Sensing along a high-current load trace will degrade DC load regulation. Feedback resistors should be placed as closely as possible to the FB pin (Pin 1) to minimize the length of the high impedance feedback trace. If possible, they should also be placed away from the LX (switching node) and inductor to improve noise immunity.
4. The resistance of the trace from the load return to PGND (Pin 10) and GND (Pin 2) should be kept to a minimum. This will help to minimize any error in DC regulation due to differences in the potential of the internal signal ground and the power ground.
5. A high density, small footprint layout can be achieved using an inexpensive, miniature, non-shielded, high DCR inductor.

Battery Charger and Step-Down Converter for Portable Applications

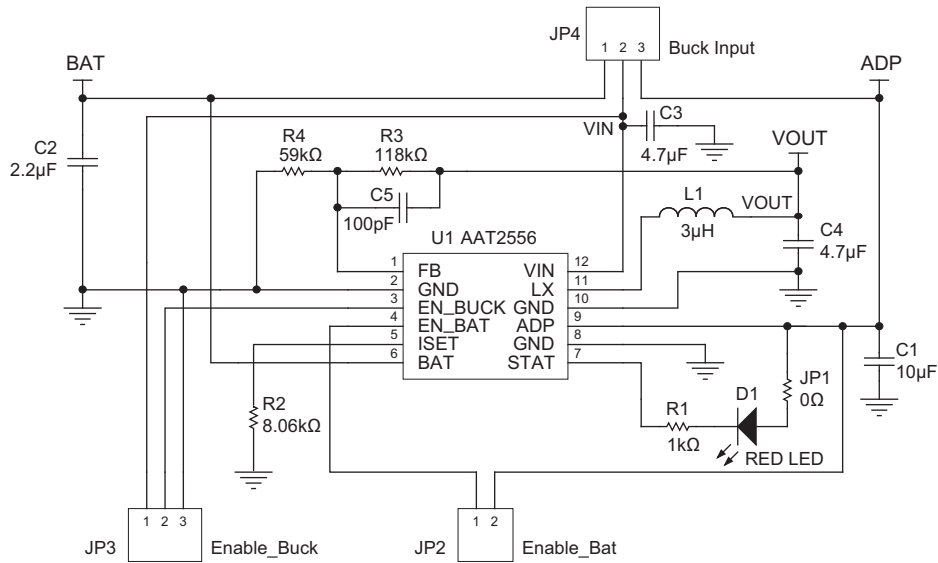

Figure 5: AAT2556 Evaluation Board Schematic.

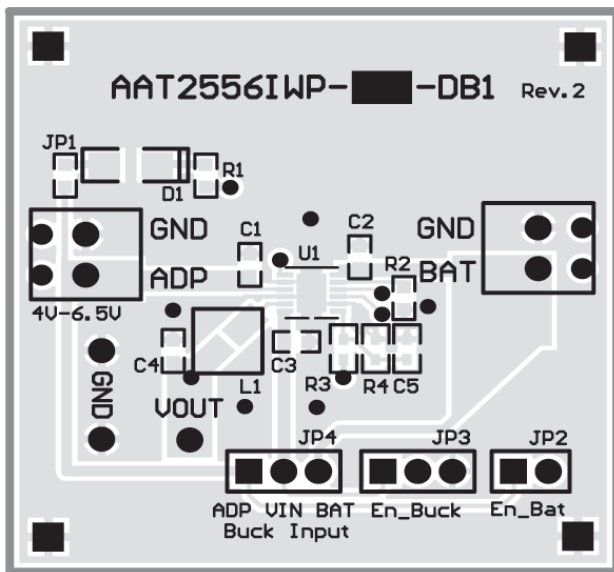

Figure 6: AAT2556 Evaluation Board Top Side Layout.

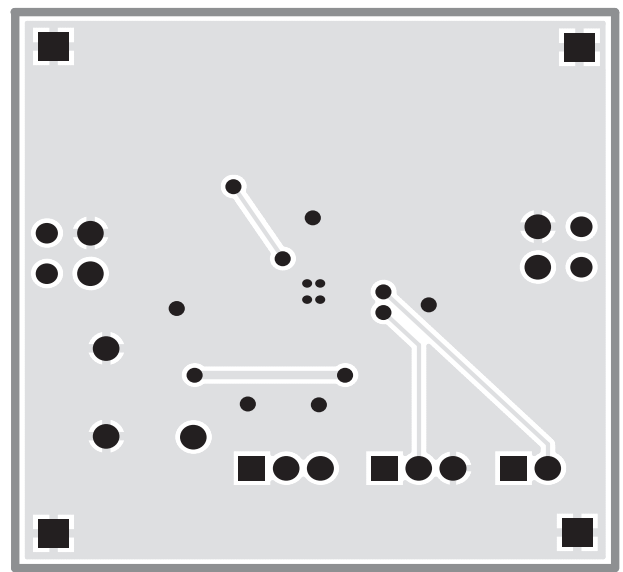

Figure 7: AAT2556 Evaluation Board Bottom Side Layout.

AAT2556**Battery Charger and Step-Down Converter for Portable Applications**

Component	Part Number	Description	Manufacturer
U1	AAT2556IWP-T1	Battery Charger and Step-Down Converter for Portable Applications; TDFN33-12 Package	Skyworks
C1	ECJ-1VB0J106M	Cer 10 μ F 10V 20% X5R 0603	Panasonic - ECG
C2	GRM185B30J225KE25D	Cer 2.2 μ F 6.3V 10% X7R 0603	Murata
C3, C4	GRM188R60J475KE19B	Cer 4.7 μ F 6.3V 10% X7R 0603	Murata
C5	GRM1886R1H101JZ01J	Cer 100pF 50V 5% R2H 0603	Murata
L1	CDRH2D09-3R0	Shielded SMD, 3.0 μ H, 150m Ω , 3x3x1mm	Sumida
R1	Chip Resistor	1K Ω , 5%, 1/4W; 0603	Vishay
R2	Chip Resistor	8.06K Ω , 1%, 1/4W; 0603	Vishay
R3	Chip Resistor	118K Ω , 1%, 1/4W; 0603	Vishay
R4	Chip Resistor	59K Ω , 1%, 1/4W; 0603	Vishay
JP1	Chip Resistor	0 Ω , 5%, 1/4W; 0603	Vishay
JP2, JP3, JP4	PRPN401PAEN	Connecting Header, 2mm Zip	Sullins Electronics
D1	CMD15-21SRC/TR8	Red LED; 1206	Chicago Miniature Lamp

Table 5: AAT2556 Evaluation Board Component Listing.

Battery Charger and Step-Down Converter for Portable Applications**Step-Down Converter Design Example****Specifications**

$V_O = 1.8V$ @ 250mA, Pulsed Load $\Delta I_{LOAD} = 200mA$

$V_{IN} = 2.7V$ to $4.2V$ (3.6V nominal)

$F_S = 1.5MHz$

$T_{AMB} = 85^\circ C$

1.8V Output Inductor

$$L1 = 1.67 \frac{\mu\text{SEC}}{\text{A}} \cdot V_{O2} = 1.67 \frac{\mu\text{SEC}}{\text{A}} \cdot 1.8V = 3\mu\text{H} \text{ (use } 3.0\mu\text{H; see Table 3)}$$

For Sumida inductor CDRH2D09-3R0, $3.0\mu\text{H}$, DCR = $150\text{m}\Omega$.

$$\Delta I_{L1} = \frac{V_O}{L1 \cdot F_S} \cdot \left(1 - \frac{V_O}{V_{IN}}\right) = \frac{1.8V}{3.0\mu\text{H} \cdot 1.5\text{MHz}} \cdot \left(1 - \frac{1.8V}{4.2V}\right) = 228\text{mA}$$

$$I_{PKL1} = I_O + \frac{\Delta I_{L1}}{2} = 250\text{mA} + 114\text{mA} = 364\text{mA}$$

$$P_{L1} = I_O^2 \cdot \text{DCR} = 250\text{mA}^2 \cdot 150\text{m}\Omega = 9.375\text{mW}$$

1.8V Output Capacitor

$$V_{\text{DROOP}} = 0.1V$$

$$C_{\text{OUT}} = \frac{3 \cdot \Delta I_{\text{LOAD}}}{V_{\text{DROOP}} \cdot F_S} = \frac{3 \cdot 0.2A}{0.1V \cdot 1.5\text{MHz}} = 4\mu\text{F}; \text{ use } 4.7\mu\text{F}$$

$$I_{\text{RMS}} = \frac{1}{2 \cdot \sqrt{3}} \cdot \frac{(V_O) \cdot (V_{\text{IN}(\text{MAX})} - V_O)}{L1 \cdot F_S \cdot V_{\text{IN}(\text{MAX})}} = \frac{1}{2 \cdot \sqrt{3}} \cdot \frac{1.8V \cdot (4.2V - 1.8V)}{3.0\mu\text{H} \cdot 1.5\text{MHz} \cdot 4.2V} = 66\text{mA}_{\text{RMS}}$$

$$P_{\text{esr}} = \text{esr} \cdot I_{\text{RMS}}^2 = 5\text{m}\Omega \cdot (66\text{mA})^2 = 21.8\mu\text{W}$$

Battery Charger and Step-Down Converter for Portable Applications**Input Capacitor**Input Ripple $V_{pp} = 25\text{mV}$

$$C_{IN} = \frac{1}{\left(\frac{V_{PP}}{I_O} - \text{ESR}\right) \cdot 4 \cdot F_S} = \frac{1}{\left(\frac{25\text{mV}}{0.2\text{A}} - 5\text{m}\Omega\right) \cdot 4 \cdot 1.5\text{MHz}} = 1.38\mu\text{F} \text{ (use } 4.7\mu\text{F)}$$

$$I_{\text{RMS}} = \frac{I_O}{2} = 0.1\text{Arms}$$

$$P = \text{esr} \cdot I_{\text{RMS}}^2 = 5\text{m}\Omega \cdot (0.1\text{A})^2 = 0.05\text{mW}$$

AAT2556 Losses

$$P_{\text{TOTAL}} = \frac{I_O^2 \cdot (R_{\text{DSON(H)}} \cdot V_O + R_{\text{DSON(L)}} \cdot [V_{\text{IN}} - V_O])}{V_{\text{IN}}} + (t_{\text{sw}} \cdot F_S \cdot I_O + I_Q) \cdot V_{\text{IN}}$$

$$= \frac{0.2^2 \cdot (0.59\Omega \cdot 1.8\text{V} + 0.42\Omega \cdot [4.2\text{V} - 1.8\text{V}])}{4.2\text{V}} + (5\text{ns} \cdot 1.5\text{MHz} \cdot 0.2\text{A} + 30\mu\text{A}) \cdot 4.2\text{V} = 26.14\text{mW}$$

$$T_{\text{J(MAX)}} = T_{\text{AMB}} + \Theta_{\text{JA}} \cdot P_{\text{LOSS}} = 85^\circ\text{C} + (50^\circ\text{C/W}) \cdot 26.14\text{mW} = 86.3^\circ\text{C}$$

Battery Charger and Step-Down Converter for Portable Applications

Output Voltage V_{OUT} (V)	R4 = 59k Ω R3 (k Ω)	R4 = 221k Ω ¹ R3 (k Ω)	L1 (μ H)
0.6 ²	—	—	1.5
0.8	19.6	75	1.5
0.9	29.4	113	1.5
1.0	39.2	150	1.5
1.1	49.9	187	1.5
1.2	59.0	221	1.5
1.3	68.1	261	1.5
1.4	78.7	301	2.2
1.5	88.7	332	2.7
1.8	118	442	3.0/3.3
1.85	124	464	3.0/3.3
2.0	137	523	3.0/3.3
2.5	187	715	3.9/4.2
3.3	267	1000	5.6

Table 6: Step-Down Converter Component Values.

Manufacturer	Part Number	Inductance (μ H)	Max DC Current (mA)	DCR (m Ω)	Size (mm) LxWxH	Type
Sumida	CDRH2D09-1R5	1.5	730	88	3.0x3.0x1.0	Shielded
Sumida	CDRH2D09-2R2	2.2	600	115	3.0x3.0x1.0	Shielded
Sumida	CDRH2D09-2R5	2.5	530	135	3.0x3.0x1.0	Shielded
Sumida	CDRH2D09-3R0	3	470	150	3.0x3.0x1.0	Shielded
Sumida	CDRH2D09-3R9	3.9	450	180	3.0x3.0x1.0	Shielded
Sumida	CDRH2D09-4R7	4.7	410	230	3.0x3.0x1.0	Shielded
Sumida	CDRH2D09-5R6	5.6	370	260	3.0x3.0x1.0	Shielded
Sumida	CDRH2D11-1R5	1.5	900	54	3.2x3.2x1.2	Shielded
Sumida	CDRH2D11-2R2	2.2	780	78	3.2x3.2x1.2	Shielded
Sumida	CDRH2D11-3R3	3.3	600	98	3.2x3.2x1.2	Shielded
Sumida	CDRH2D11-4R7	4.7	500	135	3.2x3.2x1.2	Shielded
Taiyo Yuden	NR3010	1.5	1200	80	3.0x3.0x1.0	Shielded
Taiyo Yuden	NR3010	2.2	1100	95	3.0x3.0x1.0	Shielded
Taiyo Yuden	NR3010	3.3	870	140	3.0x3.0x1.0	Shielded
Taiyo Yuden	NR3010	4.7	750	190	3.0x3.0x1.0	Shielded
FDK	MIPWT3226D-1R5	1.5	1200	90	3.2x2.6x0.8	Chip shielded
FDK	MIPWT3226D-2R2	2.2	1100	100	3.2x2.6x0.8	Chip shielded
FDK	MIPWT3226D-3R0	3	1000	120	3.2x2.6x0.8	Chip shielded
FDK	MIPWT3226D-4R2	4.2	900	140	3.2x2.6x0.8	Chip shielded

Table 7: Suggested Inductors and Suppliers.

Manufacturer	Part Number	Value (μ F)	Voltage Rating	Temp. Co.	Case Size
Murata	GRM118R60J475KE19B	4.7	6.3	X5R	0603
Murata	GRM188R60J106ME47D	10	6.3	X5R	0603

Table 8: Surface Mount Capacitors.

1. For reduced quiescent current, R4 = 221k Ω .

2. R4 is opened, R3 is shorted.

AAT2556

Battery Charger and Step-Down Converter for Portable Applications

Ordering Information

Package	Marking ¹	Part Number (Tape and Reel) ²
TDFN33-12	SPXY	AAT2556IWP-CA-T1



Skyworks Green™ products are compliant with all applicable legislation and are halogen-free.

For additional information, refer to *Skyworks Definition of Green™*, document number SQ04-0074.

Legend	
Voltage	Code
Adjustable (0.6V)	A
0.9	B
1.2	E
1.5	G
1.8	I
1.9	Y
2.5	N
2.6	O
2.7	P
2.8	Q
2.85	R
2.9	S
3.0	T
3.3	W
4.2	C

1. XYY = assembly and date code.

2. Sample stock is generally held on part numbers listed in **BOLD**.

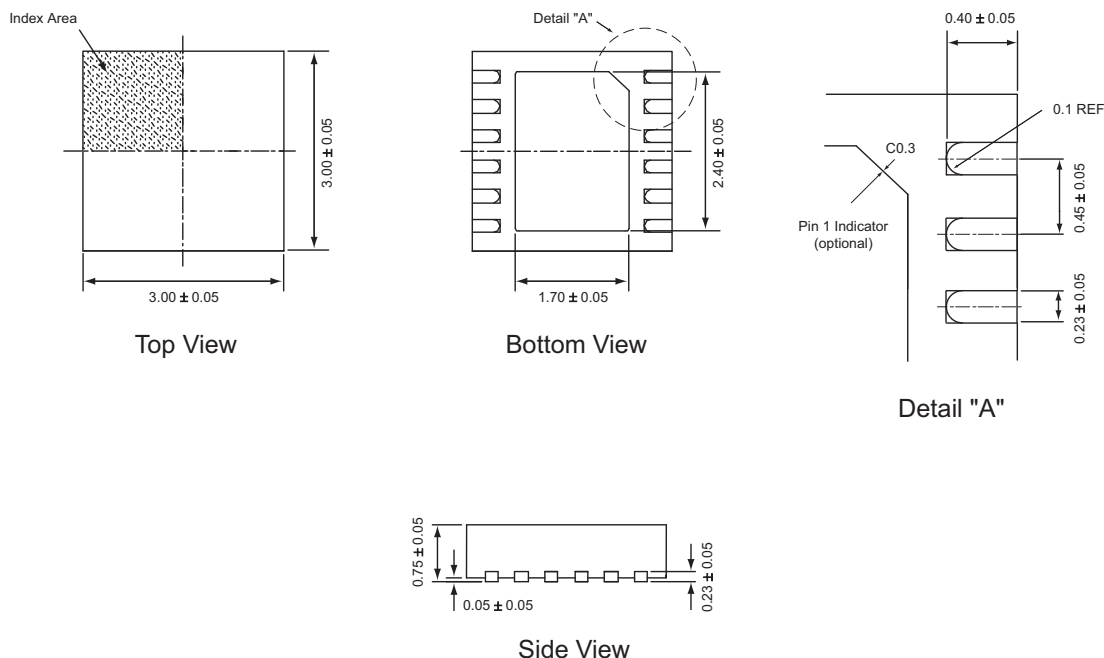
Battery Charger and Step-Down Converter for Portable Applications**Package Information****TDFN33-12¹**

All dimensions in millimeters

1. The leadless package family, which includes QFN, TQFN, DFN, TDFN and STDFN, has exposed copper (unplated) at the end of the lead terminals due to the manufacturing process. A solder fillet at the exposed copper edge cannot be guaranteed and is not required to ensure a proper bottom solder connection.

Copyright © 2012, 2013 Skyworks Solutions, Inc. All Rights Reserved.

Information in this document is provided in connection with Skyworks Solutions, Inc. ("Skyworks") products or services. These materials, including the information contained herein, are provided by Skyworks as a service to its customers and may be used for informational purposes only by the customer. Skyworks assumes no responsibility for errors or omissions in these materials or the information contained herein. Skyworks may change its documentation, products, services, specifications or product descriptions at any time, without notice. Skyworks makes no commitment to update the materials or information and shall have no responsibility whatsoever for conflicts, incompatibilities, or other difficulties arising from any future changes.

No license, whether express, implied, by estoppel or otherwise, is granted to any intellectual property rights by this document. Skyworks assumes no liability for any materials, products or information provided hereunder, including the sale, distribution, reproduction or use of Skyworks products, information or materials, except as may be provided in Skyworks Terms and Conditions of Sale.

THE MATERIALS, PRODUCTS AND INFORMATION ARE PROVIDED "AS IS" WITHOUT WARRANTY OF ANY KIND, WHETHER EXPRESS, IMPLIED, STATUTORY, OR OTHERWISE, INCLUDING FITNESS FOR A PARTICULAR PURPOSE OR USE, MERCHANTABILITY, PERFORMANCE, QUALITY OR NON-INFRINGEMENT OF ANY INTELLECTUAL PROPERTY RIGHT; ALL SUCH WARRANTIES ARE HEREBY EXPRESSLY DISCLAIMED. SKYWORKS DOES NOT WARRANT THE ACCURACY OR COMPLETENESS OF THE INFORMATION, TEXT, GRAPHICS OR OTHER ITEMS CONTAINED WITHIN THESE MATERIALS. SKYWORKS SHALL NOT BE LIABLE FOR ANY DAMAGES, INCLUDING BUT NOT LIMITED TO ANY SPECIAL, INDIRECT, INCIDENTAL, STATUTORY, OR CONSEQUENTIAL DAMAGES, INCLUDING WITHOUT LIMITATION, LOST REVENUES OR LOST PROFITS THAT MAY RESULT FROM THE USE OF THE MATERIALS OR INFORMATION, WHETHER OR NOT THE RECIPIENT OF MATERIALS HAS BEEN ADVISED OF THE POSSIBILITY OF SUCH DAMAGE.

Skyworks products are not intended for use in medical, lifesaving or life-sustaining applications, or other equipment in which the failure of the Skyworks products could lead to personal injury, death, physical or environmental damage. Skyworks customers using or selling Skyworks products for use in such applications do so at their own risk and agree to fully indemnify Skyworks for any damages resulting from such improper use or sale.

Customers are responsible for their products and applications using Skyworks products, which may deviate from published specifications as a result of design defects, errors, or operation of products outside of published parameters or design specifications. Customers should include design and operating safeguards to minimize these and other risks. Skyworks assumes no liability for applications assistance, customer product design, or damage to any equipment resulting from the use of Skyworks products outside of stated published specifications or parameters.

Skyworks, the Skyworks symbol, and "Breakthrough Simplicity" are trademarks or registered trademarks of Skyworks Solutions, Inc., in the United States and other countries. Third-party brands and names are for identification purposes only, and are the property of their respective owners. Additional information, including relevant terms and conditions, posted at www.skyworksinc.com, are incorporated by reference.