



SANYO Semiconductors

DATA SHEET

LV8112V — Bi-CMOS IC For Polygon Mirror Motor 3-phase Brushless Motor Driver

Overview

The LV8112V is a 3-phase brushless motor driver for polygon mirror motor driving of LBP.

A circuit needed to drive of polygon mirror motor can be composed of a single-chip. Also, the output transistor is made DMOS by using BiDC process, and by adopting the synchronous rectification method, the lower power consumption (Heat generation) is achieved.

Features

- 3-phase bipolar drive
- Direct PWM drive + synchronous rectification
- $I_O \text{ max1} = 2.5\text{A}$
- $I_O \text{ max1} = 3.0\text{A}$ ($t \leq 0.1\text{ms}$)
- Output current control circuit
- PLL speed control circuit
- Phase lock detection output (with mask function)
- Compatible with Hall FG
- Provides a 5V regulator output
- Full complement of on-chip protection circuits, including lock protection, current limiter, under-voltage protection, and thermal shutdown protection circuits
- Circuit to switch slowing down method while stopped (Free run or Short-circuit brake)
- Constraint protection detection signal switching circuit (FG or LD)
- Forward / Reverse switching circuit
- Hall bias pin (Bias current cut in a stopped state)
- SDCC (Speed Detection Current Control) function

Specifications

Maximum Ratings at $T_a = 25^\circ\text{C}$

Parameter	Symbol	Conditions	Ratings	Unit
Supply voltage	$V_{CC} \text{ max}$	$V_{CC} \text{ pin}$	37	V
	$V_G \text{ max}$	$V_G \text{ pin}$	42	V
Output current	$I_O \text{ max1}$	*1	2.5	A
	$I_O \text{ max2}$	$t \leq 0.1\text{ms}$ *1	3.0	A
Allowable Power dissipation	$P_d \text{ max}$	Mounted on a specified board *2	1.7	W
Operation temperature	T_{opr}		-25 to +80	$^\circ\text{C}$
Storage temperature	T_{stg}		-55 to +150	$^\circ\text{C}$
Junction temperature	$T_j \text{ max}$		150	$^\circ\text{C}$

*1. $T_j \text{ max} = 150^\circ\text{C}$ must not be exceeded.

*2. Specified board: 114.3mm × 76.1mm × 1.6mm, glass epoxy board.

■ Any and all SANYO Semiconductor Co.,Ltd. products described or contained herein are, with regard to "standard application", intended for the use as general electronics equipment (home appliances, AV equipment, communication device, office equipment, industrial equipment etc.). The products mentioned herein shall not be intended for use for any "special application" (medical equipment whose purpose is to sustain life, aerospace instrument, nuclear control device, burning appliances, transportation machine, traffic signal system, safety equipment etc.) that shall require extremely high level of reliability and can directly threaten human lives in case of failure or malfunction of the product or may cause harm to human bodies, nor shall they grant any guarantee thereof. If you should intend to use our products for applications outside the standard applications of our customer who is considering such use and/or outside the scope of our intended standard applications, please consult with us prior to the intended use. If there is no consultation or inquiry before the intended use, our customer shall be solely responsible for the use.

■ Specifications of any and all SANYO Semiconductor Co.,Ltd. products described or contained herein stipulate the performance, characteristics, and functions of the described products in the independent state, and are not guarantees of the performance, characteristics, and functions of the described products as mounted in the customer's products or equipment. To verify symptoms and states that cannot be evaluated in an independent device, the customer should always evaluate and test devices mounted in the customer's products or equipment.

LV8112V

Allowable Operating Ranges at Ta = 25°C

Parameter	Symbol	Conditions	Ratings	Unit
Supply voltage range	V _{CC}		10 to 35	V
5V constant voltage output current	I _{REG}		0 to -30	mA
LD pin applied voltage	V _{LD}		0 to 5	V
LD pin output current	I _{LD}		0 to 15	mA
FG pin applied voltage	V _{FG}		0 to 5	V
FG pin output current	I _{FG}		0 to 15	mA
HB pin applied voltage	V _{HB}		0 to 5	V
HB pin output current	I _{HB}		0 to -30	mA

Electrical Characteristics at Ta = 25°C, V_{CC} = 24V

Parameter	Symbol	Conditions	Ratings			Unit
			min	typ	max	
Current drain	I _{CC1}			5.5	6.5	mA
	I _{CC2}	In a stop state		1.0	1.5	mA
5V Constant Voltage Output						
Output voltage	V _{REG}		4.65	5.0	5.35	V
Line regulation	ΔV _{REG1}	V _{CC} = 10 to 35V		20	100	mV
Load regulation	ΔV _{REG2}	I _O = -5 to -20mA		25	60	mV
Temperature coefficient	ΔV _{REG3}	Design target value *		0		mV/°C
Output Block						
Output ON resistance	R _{ON}	I _O = 1A, Sum of the lower and upper side outputs		1.5	1.9	Ω
Output leakage current	I _{Oleak}	Design target value *			10	μA
Lower side Diode forward voltage	V _{D1}	I _D = -1A		1.0	1.35	V
Upper side Diode forward voltage	V _{D2}	I _D = 1A		1.0	1.35	V
Charge Pump Output (VG pin)						
Output voltage	V _{GOUT}			V _{CC} +4.9		V
CP1 pin						
Output ON resistance (High level)	V _{OH} (CP1)	I _{CP1} = -2mA		500	700	Ω
Output ON resistance (Low level)	V _{OL} (CP1)	I _{CP1} = 2mA		300	400	Ω
Hall Amplifier Block						
Input bias current	I _{HB} (HA)		-2	-0.5		μA
Common mode input voltage range	V _{ICM}		0.5		V _{REG} -2.0	V
Hall input sensitivity			80			mVp-p
Hysteresis	ΔV _{IN} (HA)		15	24	42	mV
Input voltage L → H	V _{SLH}			12		mV
Input voltage H → L	V _{SHL}			-12		mV
Hall Bias (HB pin) P-channel Output						
Output voltage ON resistance	V _{OL} (HB)	I _{HB} = -20mA		20	30	Ω
Output leakage current	I _L (HB)	V _O = 0V			10	μA
FG Amplifier Schmitt Block (IN1)						
Input amplifier gain	G _{FG}	Design target value *		5		times
Input hysteresis (H → L)	V _{SHL} (FGS)	Input referred, Design target value *		0		mV
Input hysteresis (L → H)	V _{SLH} (FGS)	Input referred, Design target value *		10		mV
hysteresis	V _{FGL}	Input referred, Design target value *		10		mV
FGFIL pin						
High level output voltage	V _{OH} (FGFIL)		2.7	3.0	3.3	V
Low level output voltage	V _{OL} (FGFIL)		0.75	0.85	0.95	V
External capacitor charge current	I _{CHG1}	V _{CHG1} = 1.5V	-5	-4	-3	μA
External capacitor discharge current	I _{CHG2}	V _{CHG2} = 1.5V	3	4	5	μA
Amplitude	V(FGFIL)		1.95	2.15	2.35	Vp-p

* Design target value, Do not measurement.

Continued on next page.

LV8112V

Continued from preceding page.

Parameter	Symbol	Conditions	Ratings			Unit
			min	typ	max	
FG Output						
Output ON resistance	$V_{OL}(FG)$	$I_{FG} = 7mA$		20	30	Ω
Output leakage current	$I_L(FG)$	$V_O = 5V$			10	μA
PWM Oscillator						
High level output voltage	$V_{OH}(PWM)$		2.95	3.2	3.45	V
Low level output voltage	$V_{OL}(PWM)$		1.3	1.5	1.7	V
External capacitor charge current	$I_{CHG}(PWM)$	$V_{PWM} = 2V$	-90	-70	-50	μA
Oscillation frequency	$f(PWM)$	$C = 150pF$	180	225	270	kHz
Amplitude	$V(PWM)$		1.5	1.7	1.9	Vp-p
Recommended operation frequency range	f_{OPR}		15		300	kHz
CSD Oscillation Circuit						
High level output voltage	$V_{OH}(CSD)$		2.7	3.0	3.3	V
Low level output voltage	$V_{OL}(CSD)$		0.8	1.0	1.2	V
Amplitude	$V(CSD)$		1.75	2.0	2.25	Vp-p
External capacitor charge current	$I_{CHG1}(CSD)$	$V_{CHG1} = 2.0V$	-14	-10	-6	μA
External Capacitor Discharge Current	$I_{CHG2}(CSD)$	$V_{CHG2} = 2.0V$	8	11	14	μA
Oscillation frequency	$f(CSD)$	$C = 0.068\mu F$, Design target value *	30	40	50	Hz
Phase comparing output						
Output ON resistance (high level)	V_{PDH}	$I_{OH} = -100\mu A$		500	700	Ω
Output ON resistance (low level)	V_{PDL}	$I_{OL} = 100\mu A$		500	700	Ω
Phase Lock Detection Output						
Output ON resistance	$V_{OL}(LD)$	$I_{LD} = 10mA$		20	30	Ω
Output leakage current	$I_L(LD)$	$V_O = 5V$			10	μA
Error Amplifier Block						
Input offset voltage	$V_{IO}(ER)$	Design target value *	-10		+10	mV
Input bias current	$I_B(ER)$		-1		+1	μA
High level output voltage	$V_{OH}(ER)$	$I_{OH} = -100\mu A$	EI+0.7	EI+0.85	EI+1.0	V
Low level output voltage	$V_{OL}(ER)$	$I_{OL} = 100\mu A$	EI-1.75	EI-1.6	EI-1.45	V
DC bias level	$V_B(ER)$		-5%	VREG/2	5%	V
Current Control Circuit						
Drive gain	GDF	While phase locked	0.5	0.55	0.6	times
Current Limiter Circuit (pins RF and RFS)						
Limiter voltage	V_{RF}		0.465	0.515	0.565	V
Under-voltage Protection						
Operation voltage	VSD		8.3	8.7	9.1	V
Hysteresis	ΔVSD		0.2	0.35	0.5	V
CLD Circuit						
External capacitor charge current	I_{CLD}	$V_{CLD} = 0V$	-4.5	-3.0	-1.5	μA
Operation voltage	$V_H(CLD)$		3.25	3.5	3.75	V
Thermal Shutdown Operation						
Thermal shutdown operation temperature	TSD	Design target value (Junction temperature)	150	175		$^{\circ}C$.
Hysteresis	ΔTSD	Design target value (Junction temperature)		30		$^{\circ}C$
CLK pin						
External input frequency	$f_i(CLK)$		0.1		10	kHz
High level input voltage	$V_{IH}(CLK)$		2.0		VREG	V
Low level input voltage	$V_{IL}(CLK)$		0		1.0	V
Input open voltage	$V_{IO}(CLK)$		VREG-0.5		VREG	V
Hysteresis	$V_{IS}(CLK)$		0.2	0.3	0.4	V
High level input current	$I_{IH}(CLK)$	$V_{CLK} = VREG$	-10	0	+10	μA
Low level input current	$I_{IL}(CLK)$	$V_{CLK} = 0V$	-110	-85	-60	μA

* Design target value, Do not measurement.

Continued on next page.

LV8112V

Continued from preceding page.

Parameter	Symbol	Conditions	Ratings			Unit
			min	typ	max	
CSDSEL pin						
High level input voltage	$V_{IH}(CSD)$		2.0		VREG	V
Low level input voltage	$V_{IL}(CSD)$		0		1.0	V
Input open voltage	$V_{IO}(CSD)$		VREG-0.5		VREG	V
High level input current	$I_{IH}(CSD)$	$V_{CSD} = VREG$	-10	0	+10	μA
Low level input current	$I_{IL}(CSD)$	$V_{CSD} = 0V$	-110	-85	-60	μA
S/S pin						
High level input voltage	$V_{IH}(SS)$		2.0		VREG	V
Low level input voltage	$V_{IL}(SS)$		0		1.0	V
Input open voltage	$V_{IO}(SS)$		VREG-0.5		VREG	V
Hysteresis	$V_{IS}(SS)$		0.2	0.3	0.4	V
High level input current	$I_{IH}(SS)$	$V_{S/S} = VREG$	-10	0	+10	μA
Low level input current	$I_{IL}(SS)$	$V_{S/S} = 0V$	-110	-85	-60	μA
BRSEL pin						
High level input voltage	$V_{IH}(BRSEL)$		2.0		VREG	V
Low level input voltage	$V_{IL}(BRSEL)$		0		1.0	V
Input open voltage	$V_{IO}(BRSEL)$		VREG-0.5		VREG	V
High level input current	$I_{IH}(BRSEL)$	$V_{BRSEL} = VREG$	-10	0	+10	μA
Low level input current	$I_{IL}(BRSEL)$	$V_{BRSEL} = 0V$	-110	-85	-60	μA
F/R pin						
High level input voltage	$V_{IH}(FR)$		2.0		VREG	V
Low level input voltage	$V_{IL}(FR)$		0		1.0	V
Input open voltage	$V_{IO}(FR)$		VREG-0.5		VREG	V
High level input current	$I_{IH}(FR)$	$V_{F/R} = VREG$	-10	0	+10	μA
Low level input current	$I_{IL}(FR)$	$V_{F/R} = 0V$	-110	-85	-60	μA

LV8112V

Package Dimensions

unit : mm (typ)
3333

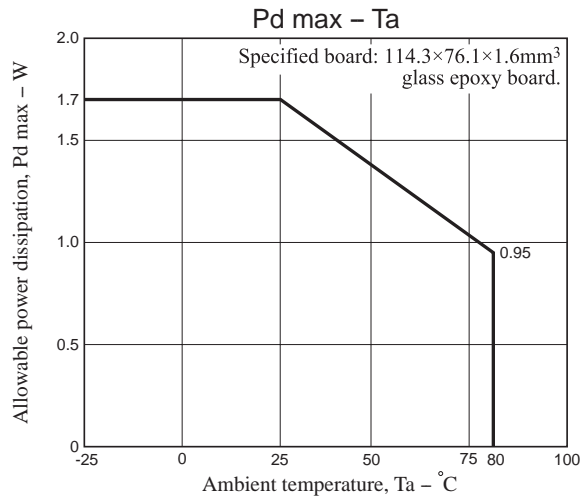
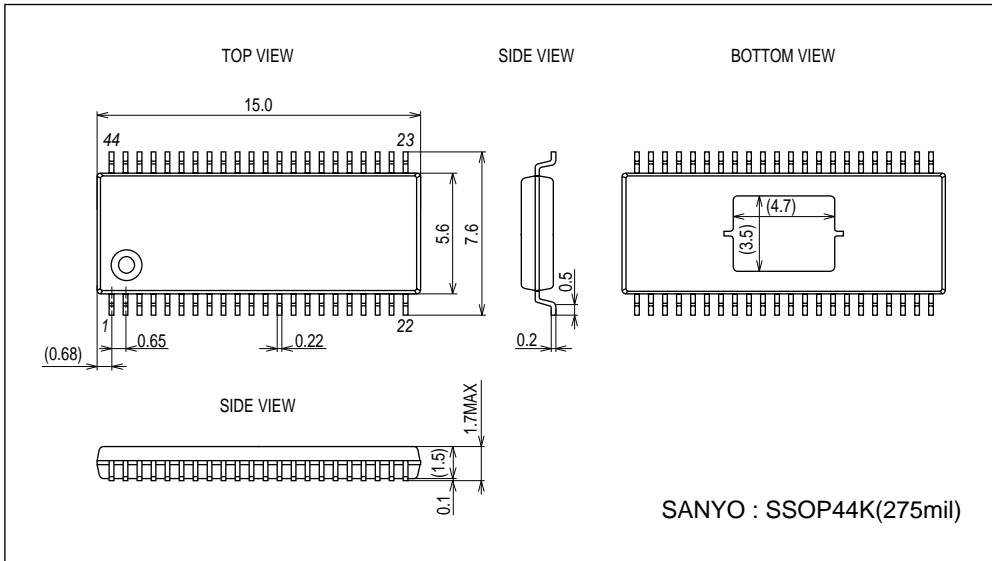

Pin Assignment

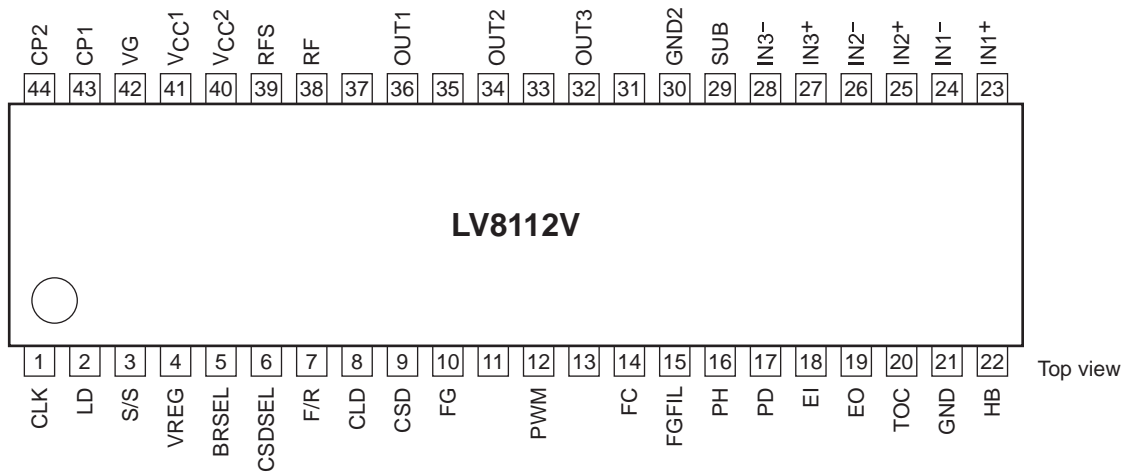

LV8112V

Block Diagram and Application Circuit Example

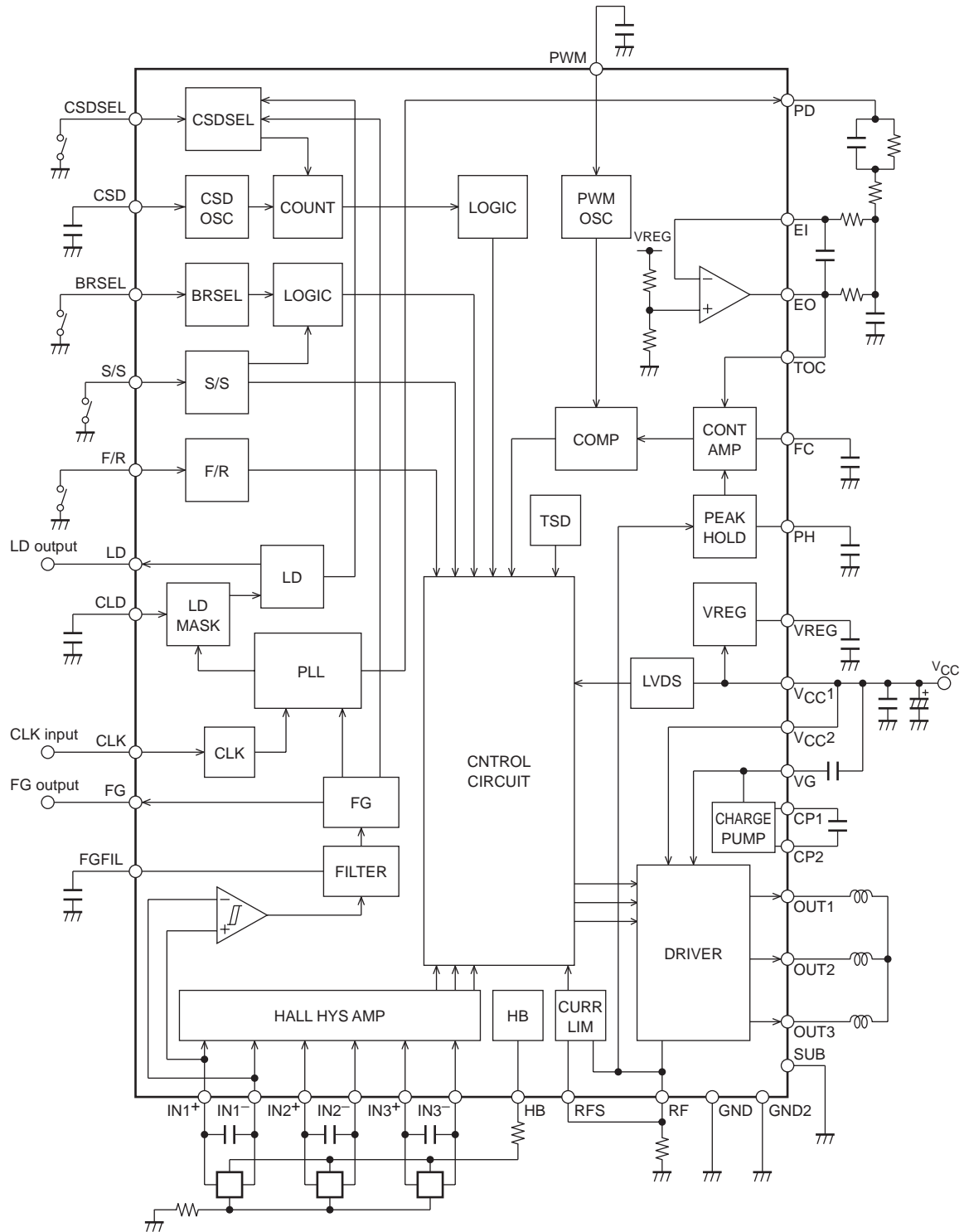

LV8112V

Pin Function

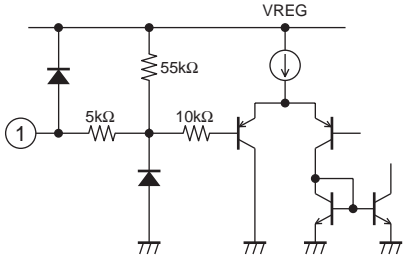
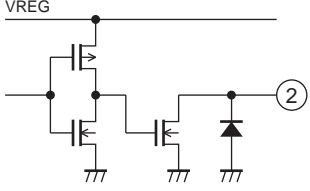
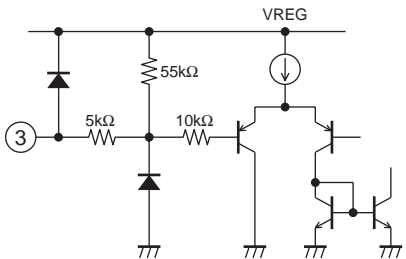
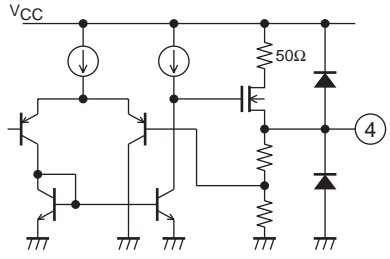
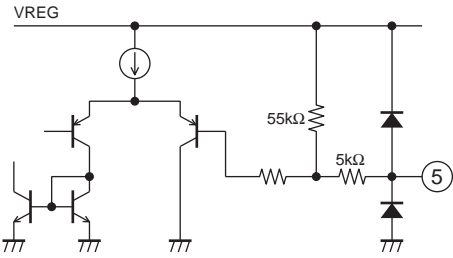
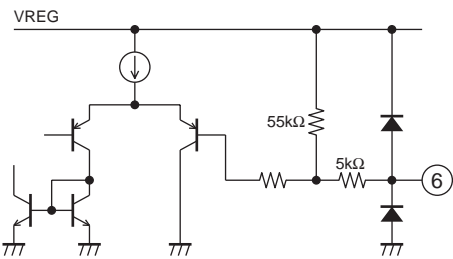
Pin No.	Pin name	Function	Equivalent circuit
1	CLK	Clock input pin (10kHz maximum)	 <p>The equivalent circuit for the CLK pin (pin 1) shows a pull-up resistor of 55kΩ connected to the VREG supply. The pin is also connected to a 5kΩ resistor and a diode to ground. The signal path includes a 10kΩ resistor and a transistor driver circuit connected to the VREG supply.</p>
2	LD	Phase lock detection output pin. Goes ON during PLL-phase lock. Open drain output.	 <p>The equivalent circuit for the LD pin (pin 2) shows an open-drain output configuration. It features a pull-up resistor connected to the VREG supply and a transistor driver circuit connected to ground.</p>
3	S/S	Start/Stop input pin. START with a low-level input. STOP with a high-level input or open input	 <p>The equivalent circuit for the S/S pin (pin 3) is identical to the CLK pin, featuring a 55kΩ pull-up resistor to VREG, a 5kΩ resistor, a diode to ground, and a 10kΩ resistor leading to the transistor driver circuit.</p>
4	VREG	5V regulator output pin. (the control circuit power supply) Connect a capacitor between this pin and GND for stabilization.	 <p>The equivalent circuit for the VREG pin (pin 4) shows a 5V regulator output stage. It includes a 50Ω resistor, a diode to ground, and a transistor driver circuit connected to the VCC supply.</p>
5	BRSEL	Brake selection pin. By low level, short-circuit braking when the S/S pin is in a stopped state. (Brake for the inspection process)	 <p>The equivalent circuit for the BRSEL pin (pin 5) shows a pull-up resistor of 55kΩ connected to the VREG supply. The pin is also connected to a 5kΩ resistor and a diode to ground. The signal path includes a transistor driver circuit connected to the VREG supply.</p>
6	CSDSEL	Motor constraint protection detection signal selection pin. Select FG with low, and LD with high or in an open state.	 <p>The equivalent circuit for the CSDSEL pin (pin 6) is identical to the BRSEL pin, featuring a 55kΩ pull-up resistor to VREG, a 5kΩ resistor, a diode to ground, and a transistor driver circuit.</p>

Continued on next page.

LV8112V

Continued from preceding page.

Pin No.	Pin name	Function	Equivalent circuit
7	F/R	Pin to select Forward / Reverse. (Pin to select SDCC function)	
8	CLD	Pin to set phase lock signal mask time. Connect a capacitor between this pin and GND. If there is no need for masking, this pin must be left open.	
9	CSD	Pin for both the constraint protection circuit operation time and the initial reset pulse setting. Connect a capacitor between this pin and GND. If the motor constraint protection circuit is not used, a capacitor and a resistor must be connected in parallel between the CSD pin and GND.	
10	FG	FG Schmitt output pin. Open drain output.	
12	PWM	Pin to set the oscillation frequency of PWM. Connect a capacitor between this pin and GND.	
14	FC	Frequency characteristics correction pin of the current limiter circuit. Connect a capacitor between this pin and GND.	

Continued on next page.

LV8112V

Continued from preceding page.

Pin No.	Pin name	Function	Equivalent circuit
15	FGFIL	FG filter pin. When the noise of the FG signal is a problem, connect a capacitor between this pin and GND for stabilization.	
16	PH	Pin to stabilize the RF waveform. Connect a capacitor between this pin and GND.	
17	PD	Phase comparison output pin. The phase error is output by the duty changing of the pulse.	
18	EI	Error amplifier input pin.	
19	EO	Error amplifier output pin.	
20	TOC	Torque command voltage input pin. Normally, this pin must be connected with the EO pin.	
21	GND	Ground pin of the control circuit block.	

Continued on next page.

LV8112V

Continued from preceding page.

Pin No.	Pin name	Function	Equivalent circuit
22	HB	Hall element bias current pin. Goes ON when the S/S pin is in a start state. Goes OFF when the S/S pin is in a stopped state.	
23 24 25 26 27 28	IN1+ IN1- IN2+ IN2- IN3+ IN3-	Hall amplifier input pin. A high level state of logic is recognized when IN+ > IN-. In reverse case is a low-level state. The input amplitude of 100mVp-p or more (differential) is desirable in the Hall sensor inputs. If noise on the Hall inputs is a problem, that noise must be excluded by inserting capacitors across the inputs.	
29	SUB	Frame ground pin. This pin is connected with the GND2 pin.	
30	GND2	Ground pin of the output circuit block.	
32 34 36	OUT3 OUT2 OUT1	Output pin. As for PWM, Duty control is executed on the upper-side FET.	
38	RF	Source pin of output MOSFET (lower-side). Connect a low resistance (Rf) between this pin and GND.	
39	RFS	Output current detection pin. Connect to RF pin.	
40	VCC2	Power supply pin. Connect a capacitor between this pin and GND for stabilization.	
41	VCC1	Power supply pin for control.	
42 43 44	VG CP1 CP2	Charge pump output pin (Power supply for the upper side FET gate). Connect a capacitor between this pin and VCC. Pin to connect a capacitor for charge pump. Connect a capacitor between CP1 and CP2.	

LV8112V

3-phase Logic Truth Table (IN = "H" indicates the state where $IN^+ > IN^-$)

F/R = H			F/R = L			Output		
IN1	IN2	IN3	IN1	IN2	IN3	OUT1	OUT2	OUT3
H	L	H	L	H	L	L	H	M
H	L	L	L	H	H	L	M	H
H	H	L	L	L	H	M	L	H
L	H	L	H	L	H	H	L	M
L	H	H	H	L	L	H	M	L
L	L	H	H	H	L	M	H	L

S/S Pin

Input state	Mode
High or Open	Stop
Low	Start

BRSEL Pin

Input state	While stopped
High or Open	Free run
Low	Short-circuit brake

CSDSEL Pin

Input state	Mode
High or Open	LD standard
Low	FG standard

SDCC Select

Input state	Mode
F/R = High or Open	Function ON
F/R = Low	Function OFF

LV8112V Description

1. Speed Control Circuit

This IC can realize a high efficiency, low-jitter, a stable rotation by adopting the PLL speed control method.

This the PLL circuit compares the phase difference of the edge between the CLK signal and the FG signal and controls by using the output of error. The FG servo frequency under control becomes congruent with the CLK frequency.

$$f_{FG} (\text{Servo}) = f_{CLK}$$

2. Output Drive Circuit

This IC adopts the direct PWM drive method to reduce power loss in the output. The output transistor is always saturated while the transistor is on and adjusts the driving force of the motor by changing the duty that the output transistor is on.

The PWM switching of the output is performed by the upper-side output transistor.

Also, this IC has a parasitic diode of the output DMOS as a regeneration route when the PWM switching is off.

But, this IC is cut down the fever than the diode regeneration by performing synchronous rectification.

3. Current Limiter Circuit

This IC limits the (peak) current at the value

$$I = V_{RF} / R_f \quad (V_{RF} = 0.515V \text{ (typical)}, R_f : \text{current detection resistor}).$$

The current limitation operation consists of reducing the PWM output on duty to suppress the current.

To prevent malfunction of the current limitation operation when the reverse recovery current of diode is detected, the operation has a delay (approximately 300ns). In case of a coil resistance of motor is small or small inductance, since the current change at start-up is fast, there is a possibility that the current more than specified current is flowed by this delay.

It is necessary to set the current increases by the delay.

4. Power Saving Circuit

This IC becomes the power saving state of decreasing the consumption current in the stop state. The bias current of the majority circuits is cut in the power saving state. Also, 5V regulator output is output in the power saving state.

5. Reference Clock

Note that externally-applied clock signal has no noise of chattering. The input circuit has a hysteresis.

But, if noise is a problem, that noise must be excluded by inserting capacitors across the inputs.

If clock input goes to the no input state when the IC is in the start state, the drive is turned off after a few rotation of motor if the motor constrained protection circuit does operate. (Clock disconnection protection)

6. PWM Frequency

The PWM frequency is determined by using a capacitor C (F) connected to the PWM pin.

$$f_{\text{PWM}} \approx 1 / (29500 \times C) \cdots 150\text{pF or more}$$

$$f_{\text{PWM}} \approx 1 / (32000 \times C) \cdots 100\text{pF or more, less than 150pF}$$

The frequency is oscillated at about 225kHz when a capacitor of 150pF is connected.

The GND of a capacitor must be placed as close to the control block GND (GND pin) of the IC as possible to reduce influence of the output.

7. Hall Effect Sensor Input Signals

The signal input of the amplitude of hysteresis of 42mV max or more is required in the Hall effect sensor inputs.

Also, an input amplitude of over 100mVp-p is desirable in the Hall effect sensor inputs in view of influence of noise.

If the output waveform (when the phase changes) is distorted by noise, that noise must be excluded by inputting capacitors across the inputs.

8. FG Signals

The Hall signal of IN1 is used as the FG signal in the IC. If noise is a problem, the noise of the FG signal can be excluded by inserting a capacitor between the FGFIL pin and GND.

Note that normal operation becomes impossible if the value of the capacitor is overlarge. Also, note that the trouble of noise occurs easily when the position of GND of a capacitor is incorrect.

9. Constraint Protection Circuit

This IC has an on-chip constraint protection circuit to protect the IC and the motor in motor constraint mode. when the CSDSEL pin is set to the high level or open input, if the LD output remains high (unlocked statement) for a fixed period in the start state, this circuit operates. In the low level setting case, if the FG signal is not switched for a fixed period in the start state, this circuit is operates. Also, the upper-side output transistor is turned off while the constraint protection circuit is operating. This time is set by the capacitance of the capacitor attached to the CSD pin.

$$\text{The set time (in seconds) is } 102 \times C (\mu\text{F})$$

When a capacitor of 0.068μF is attached, the protection time becomes about 7.0 seconds.

The set time must be set well in advance for the motor start-up time. When the motor is decelerated by switching the clock frequency, this protection circuit is not operated. To clear the motor constrained state, the S/S pin is switched into a stop state or the power must be turned off and reapplied. Since the CSD pin also functions as the power-on reset pin, if the CSD pin were connected directly to ground, the logic circuit goes to the reset state and the speed cannot be controlled.

Therefore, if the motor constraint protection circuit is not used, a resistor of about 220kΩ and a capacitor of about 4700pF must be connected in parallel between the CSD pin and GND.

10. Phase Lock Signals

(1) Phase lock range

This IC has no the speed system counter. The speed error range in the phase lock state is indeterminable only by the characteristics of the IC. (because the accelerations of the change in FG frequency influences.)

When it is necessary to specify for the speed error as a motor, the value obtained while the motor is actually operating must be measured. Since the speed error occurs easily when the accelerations of FG is large, the speed error will be the largest when the IC goes into the lock state during start-up or the unlocked state by switching the clock.

(2) Phase lock signal mask functions

When the IC goes into the lock state during start-up or the unlocked state by switching the clock, the low signal for a short-time by using the hunting when the IC goes into the locked state is masked. Therefore, the lock signal is output in stable state. But, the mask time duration causes the delay of the lock signal output. The mask time is set by the capacitance of the capacitor attached between the CLD pin and GND.

$$\text{The mask time (seconds) is } 1.8 \times C (\mu\text{F})$$

When a capacitor of 0.1μF is attached, the mask time becomes about 180ms.

If the signals should be masked completely, the mask time must be set well in advance.

When there is no need for masking, the CLD pin must be left open.

11. Power Supply Stabilization

Since this IC is used in applications that draw large output currents and adopts the drive method by switching, the power-Supply line is subject to fluctuations. Therefore, capacitors with capacitances adequate to stabilize the power-supply voltage must be connected between the V_{CC} pin and GND. The ground-side a capacitor must be connected as close to the GND2 pin of power GND as possible. If it is impossible to connect a capacitor (electrolytic capacitor) near the pin, the ceramic capacitor of about 0.1μF must be connected as close to the pin as possible.

If diodes are inserted in the power-supply line to prevent IC destruction due to reverse power supply connection, Since this makes the power-supply voltage even more subject to fluctuations, even larger capacitors will be required.

12. VREG Stabilization

To stabilize the VREG voltage that is the power supply of the control circuit, connect a capacitor of 0.1μF or more. GND of the capacitor must be attached as close to the control block GND (GND1 pin) of the IC as possible.

13. Error Amplifier

External components of the error amplifier block must be placed as close to the IC as possible to reduce influence of noise.

Also, these components must be placed as separate from the motor as possible.

14. IC Reverse Metal

To improve heat radiation, the metal part on the reverse of IC is stuck fast to the substrate by using highly-conduction solder.

15. SDCC (Speed Detection Current Control) function

The SDCC circuit controls the speed detection current. It limits the current to 87.5% of the specified current to reduce acceleration of the motor when the rotation of the motor exceeds 95% of its target speed. This enables stabilized phase lock pull-in and minimizes the variation in startup time.

The SDCC function is disabled by setting F/R low. It is enabled by setting F/R high or open.

Notes: If the selected state of SDCC does not match the rotational direction of the motor, it is necessary to solve the problem by changing the HALL bias.

- SANYO Semiconductor Co.,Ltd. assumes no responsibility for equipment failures that result from using products at values that exceed, even momentarily, rated values (such as maximum ratings, operating condition ranges, or other parameters) listed in products specifications of any and all SANYO Semiconductor Co.,Ltd. products described or contained herein.
- SANYO Semiconductor Co.,Ltd. strives to supply high-quality high-reliability products, however, any and all semiconductor products fail or malfunction with some probability. It is possible that these probabilistic failures or malfunction could give rise to accidents or events that could endanger human lives, trouble that could give rise to smoke or fire, or accidents that could cause damage to other property. When designing equipment, adopt safety measures so that these kinds of accidents or events cannot occur. Such measures include but are not limited to protective circuits and error prevention circuits for safe design, redundant design, and structural design.
- In the event that any or all SANYO Semiconductor Co.,Ltd. products described or contained herein are controlled under any of applicable local export control laws and regulations, such products may require the export license from the authorities concerned in accordance with the above law.
- No part of this publication may be reproduced or transmitted in any form or by any means, electronic or mechanical, including photocopying and recording, or any information storage or retrieval system, or otherwise, without the prior written consent of SANYO Semiconductor Co.,Ltd.
- Any and all information described or contained herein are subject to change without notice due to product/technology improvement, etc. When designing equipment, refer to the "Delivery Specification" for the SANYO Semiconductor Co.,Ltd. product that you intend to use.
- Information (including circuit diagrams and circuit parameters) herein is for example only; it is not guaranteed for volume production.
- Upon using the technical information or products described herein, neither warranty nor license shall be granted with regard to intellectual property rights or any other rights of SANYO Semiconductor Co.,Ltd. or any third party. SANYO Semiconductor Co.,Ltd. shall not be liable for any claim or suits with regard to a third party's intellectual property rights which has resulted from the use of the technical information and products mentioned above.

This catalog provides information as of January, 2010. Specifications and information herein are subject to change without notice.