

Multilayer Diplexers

For 2.4/5.0 GHz W-LAN

DPX Series

Type: **DPX205950DT-9126A1 (2.0×1.25×0.6mm max.)**
 DPX205950DT-9026A1 (2.0×1.25×0.6mm max.)
 DPX205850DT-4043A1 (2.0×1.25×0.95mm)
 DPX205950DT-9008A1 (2.0×1.25×0.95mm)
 DPX205950DT-9108A1 (2.0×1.25×0.95mm)

Issue date: December 2010

- All specifications are subject to change without notice.
 - Conformity to RoHS Directive: This means that, in conformity with EU Directive 2002/95/EC, lead, cadmium, mercury, hexavalent chromium, and specific bromine-based flame retardants, PBB and PBDE, have not been used, except for exempted applications.
-

Multilayer Chip Diplexers For 2.4/5GHz W-LAN

Conformity to RoHS Directive

DPX Series DPX205950DT-9126A1

SHAPES AND DIMENSIONS

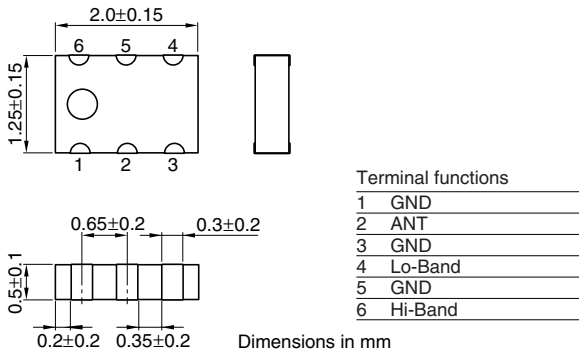

RECOMMENDED PC BOARD PATTERNS

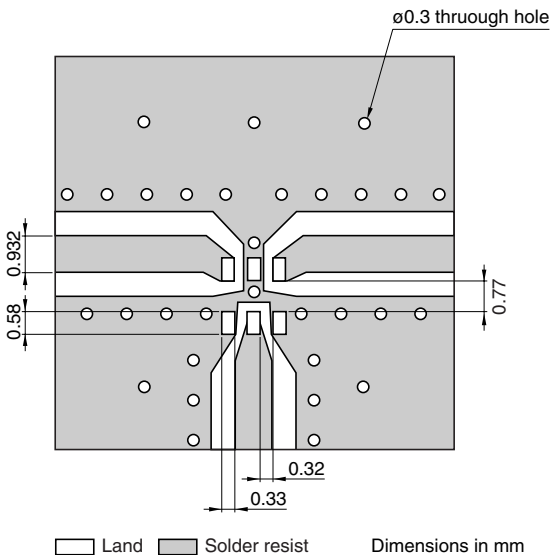

ELECTRICAL CHARACTERISTICS

Item	Port	Frequency range		Minimum value	Typical value	Maximum value
Insertion loss	Lo-band	[2400 to 2500MHz]	(dB)	—	0.3	0.5
	Hi-band	[4900 to 5950MHz]	(dB)	—	0.37	0.65
Return loss	ANT	[2400 to 2500MHz]	(dB)	10.0	18.4	—
	ANT	[4900 to 5950MHz]	(dB)	10.0	17.1	—
	Lo	[2400 to 2500MHz]	(dB)	10.0	17.1	—
	Hi	[4900 to 5950MHz]	(dB)	10.0	15.9	—
	Lo-band	[4800 to 5000MHz]	(dB)	20.0	36.0	—
Attenuation	Lo-band	[7200 to 7500MHz]	(dB)	20.0	31.6	—
	Hi-band	[824 to 915MHz]	(dB)	20.0	26.9	—
	Hi-band	[1800 to 2500MHz]	(dB)	20.0	27.6	—
	Hi-band	[9800 to 11900MHz]	(dB)	15.0	20.9	—
Isolation		[DC.2500MHz]	(dB)	20.0	25.6	—
		[4900 to 5950MHz]	(dB)	20.0	23.8	—
Temperature range	Operating		(°C)	-40	—	+85
	Storage		(°C)	-40	—	+85

• Ta: +25°C

• Conformity to RoHS Directive: This means that, in conformity with EU Directive 2002/95/EC, lead, cadmium, mercury, hexavalent chromium, and specific bromine-based flame retardants, PBB and PBDE, have not been used, except for exempted applications.

• All specifications are subject to change without notice.

FREQUENCY CHARACTERISTICS

Lo-BAND PORT S31

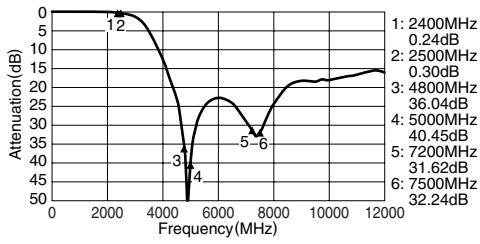

Hi-BAND PORT S21

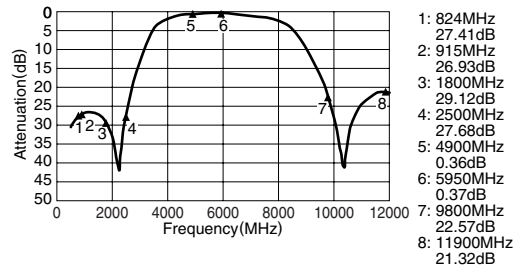

COMMON PORT RETURN LOSS S11

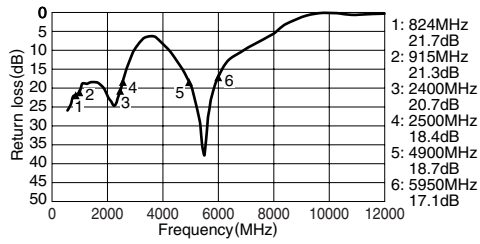

ISOLATION S23

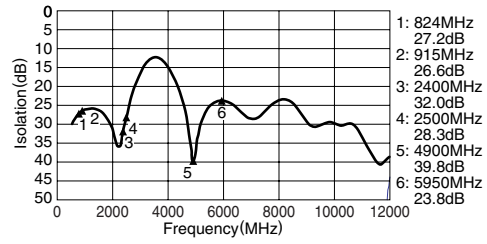

Lo-BAND PORT RETURN LOSS S33

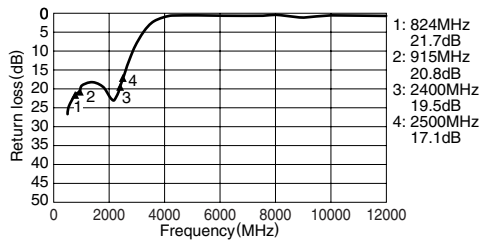

Hi-PORT RETURN LOSS S22

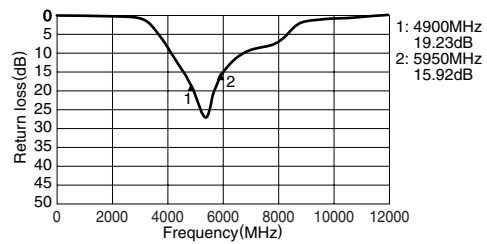

• All specifications are subject to change without notice.

Multilayer Chip Diplexers For 2.4/5GHz W-LAN

Conformity to RoHS Directive

DPX Series DPX205950DT-9026A1

SHAPES AND DIMENSIONS

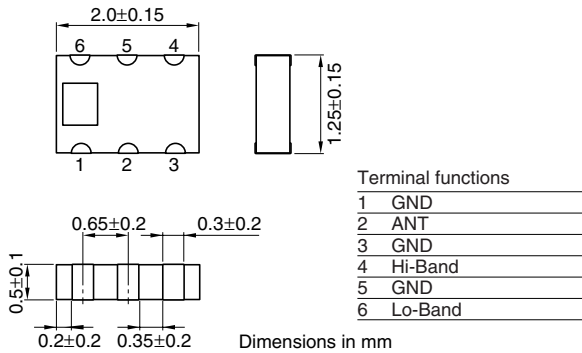

RECOMMENDED PC BOARD PATTERNS

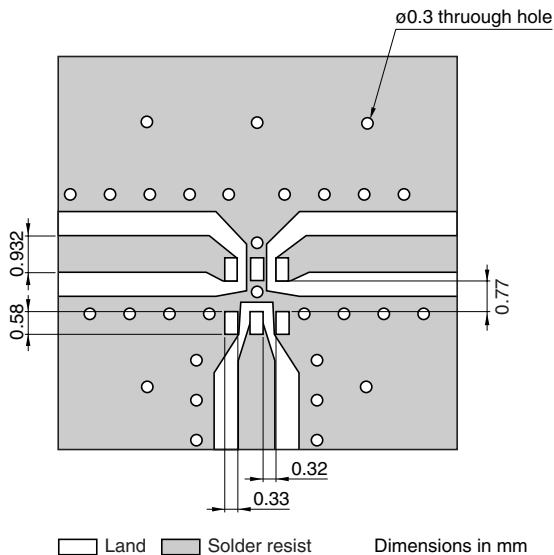

ELECTRICAL CHARACTERISTICS

Item	Port	Frequency range	Minimum value	Typical value	Maximum value
Insertion loss	Lo-band	[2400 to 2500MHz]	(dB) —	0.39	0.50
	Hi-band	[4900 to 5950MHz]	(dB) —	0.39	0.65
Return loss	ANT	[2400 to 2500MHz]	(dB) 10	16.5	—
		[4900 to 5950MHz]	(dB) 10	17.2	—
	Lo	[2400 to 2500MHz]	(dB) 10	15.5	—
		Hi	[4900 to 5950MHz]	(dB) 10	17.0
Attenuation	Lo-band	[4800 to 5000MHz]	(dB) 20	34.7	—
		[7200 to 7500MHz]	(dB) 20	25.2	—
	Hi-band	[824 to 915MHz]	(dB) 20	26.9	—
Isolation		[1800 to 2500MHz]	(dB) 20	26.2	—
		[9800 to 11900MHz]	(dB) 15	20.6	—
		[DC to 2500MHz]	(dB) 20	25.6	—
Temperature range		[4900 to 5950MHz]	(dB) 20	25.0	—
		Operating	(°C) -40	—	+85
		Storage	(°C) -40	—	+85

• Ta: +25°C

• Conformity to RoHS Directive: This means that, in conformity with EU Directive 2002/95/EC, lead, cadmium, mercury, hexavalent chromium, and specific bromine-based flame retardants, PBB and PBDE, have not been used, except for exempted applications.

• All specifications are subject to change without notice.

FREQUENCY CHARACTERISTICS

Lo-BAND PORT S21

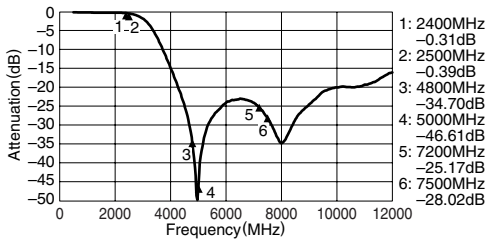

Hi-BAND PORT S31

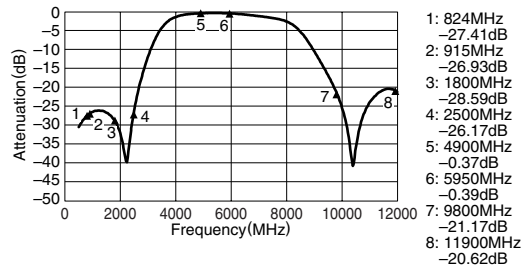

COMMON PORT RETURN LOSS S11

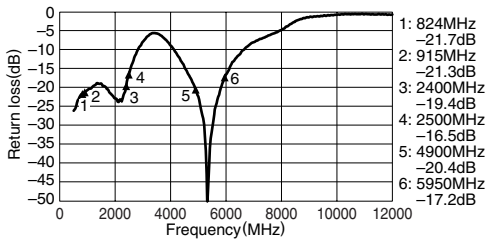

ISOLATION S23

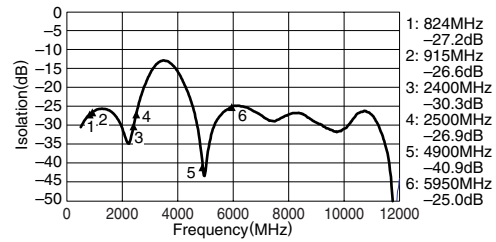

Lo-BAND PORT RETURN LOSS S22

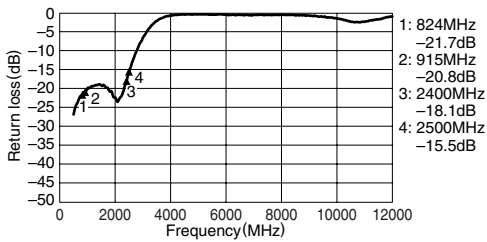

Hi-PORT RETURN LOSS S33

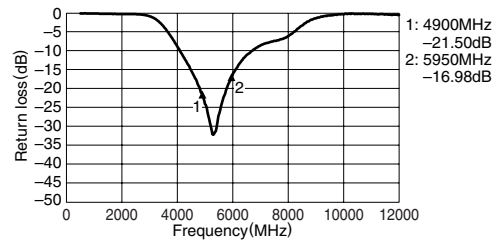

• All specifications are subject to change without notice.

Multilayer Chip Diplexers

For 2.4/5GHz W-LAN

Conformity to RoHS Directive

DPX Series DPX205850DT-4043A1

SHAPES AND DIMENSIONS

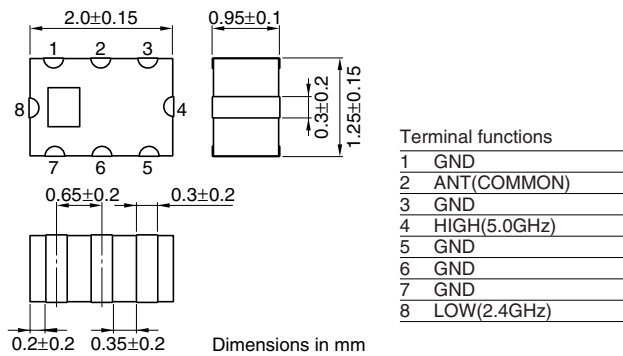

RECOMMENDED PC BOARD PATTERNS

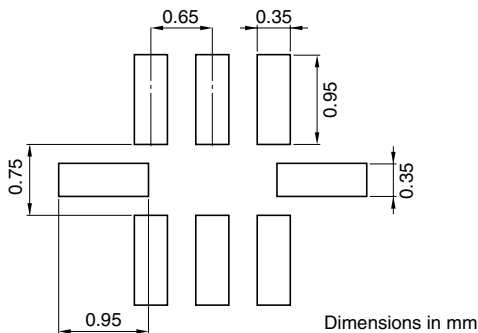

ELECTRICAL CHARACTERISTICS

Item	Port	Frequency range	Minimum value	Typical value	Maximum value
Insertion loss	ANT-LOW	[2400 to 2500MHz]	(dB) —	0.28	0.50
	ANT-HIGH	[4900 to 5850MHz]	(dB) —	0.45	0.75
Attenuation	ANT-LOW	[4900 to 5850MHz]	(dB) 17.0	22.9	—
	ANT-HIGH	[2400 to 2500MHz]	(dB) 21.0	33.0	—
Return loss	ANT	[2400 to 2500MHz]	(dB) 12.0	17.5	—
	ANT	[4900 to 5850MHz]	(dB) 11.0	16.7	—
	LOW	[2400 to 2500MHz]	(dB) 12.0	18.9	—
	HIGH	[4900 to 5850MHz]	(dB) 11.0	16.2	—
Power capacity			(W) —	—	3
Temperature range		Operating	(°C) -40	—	+85
		Storage	(°C) -40	—	+85

• Ta: 25±5°C

• Conformity to RoHS Directive: This means that, in conformity with EU Directive 2002/95/EC, lead, cadmium, mercury, hexavalent chromium, and specific bromine-based flame retardants, PBB and PBDE, have not been used, except for exempted applications.

• All specifications are subject to change without notice.

FREQUENCY CHARACTERISTICS

Lo-BAND PORT S21

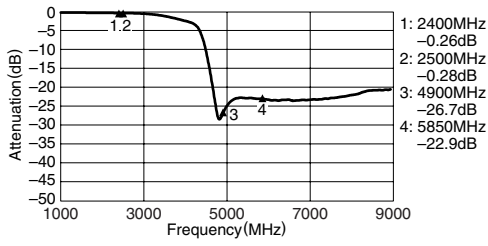

Hi-BAND PORT S31

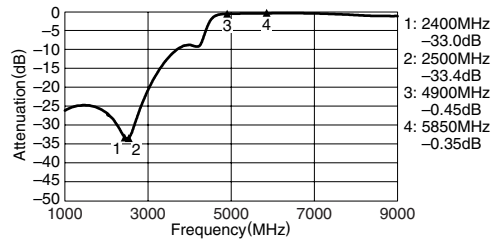

COMMON PORT RETURN LOSS S11

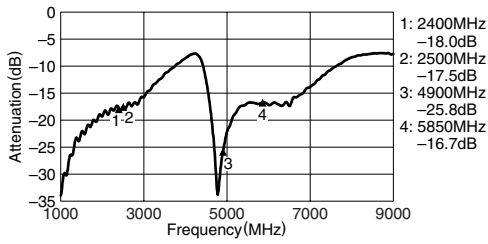

ISOLATION S23

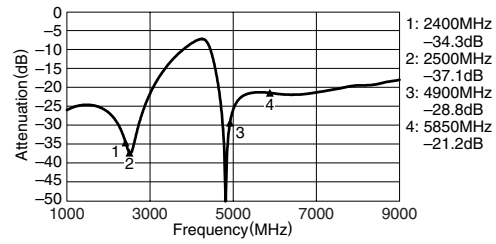

Lo-BAND PORT RETURN LOSS S22

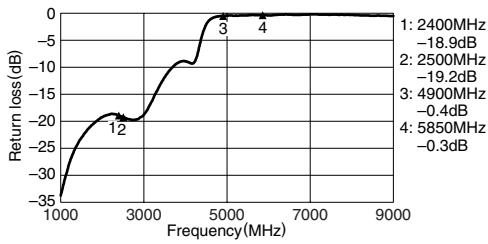

Hi-PORT RETURN LOSS S33

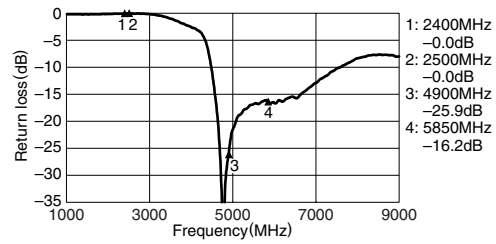

• All specifications are subject to change without notice.

Multilayer Chip Diplexers For 2.4/5GHz W-LAN

Conformity to RoHS Directive

DPX Series DPX205950DT-9008A1

SHAPES AND DIMENSIONS

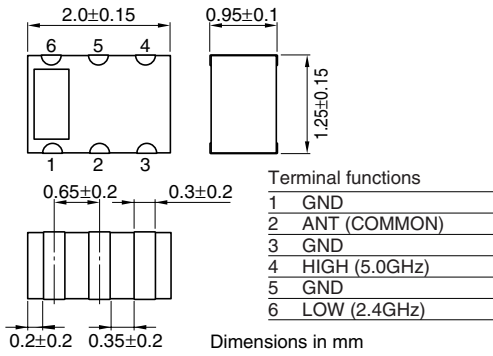

CIRCUIT DIAGRAM

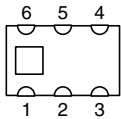

RECOMMENDED PC BOARD PATTERNS

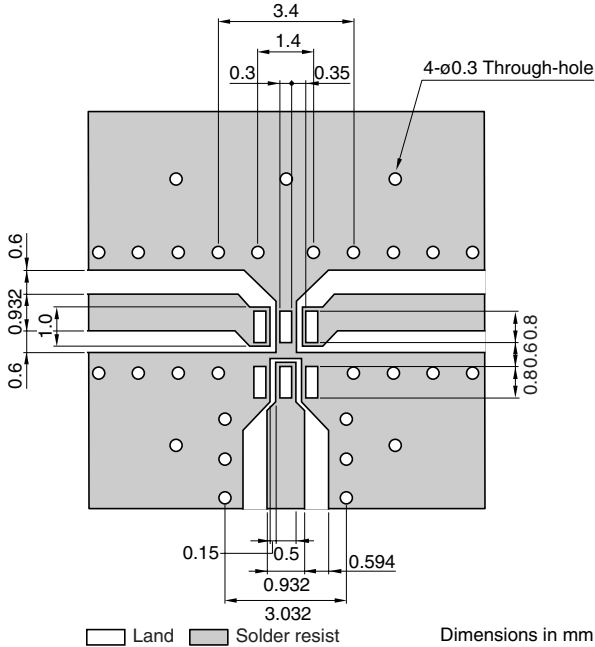

Line width be designed to match 50Ω characteristic impedance depending on PCB material and thickness.

• Conformity to RoHS Directive: This means that, in conformity with EU Directive 2002/95/EC, lead, cadmium, mercury, hexavalent chromium, and specific bromine-based flame retardants, PBB and PBDE, have not been used, except for exempted applications.

• All specifications are subject to change without notice.

ELECTRICAL CHARACTERISTICS

Item	Port	Frequency range	Minimum value	Typical value	Maximum value
Insertion loss	ANT-LOW	[25±5°C]	2300 to 2500MHz (dB)	—	0.65
		[-40 to +85°C]	2300 to 2500MHz (dB)	—	0.8
	ANT-HIGH	[25±5°C]	4900 to 5950MHz (dB)	—	1.4
Attenuation	ANT-LOW	4600 to 5000MHz (dB)	20	—	—
		6900 to 7500MHz (dB)	20	—	—
	ANT-HIGH	2300 to 2500MHz (dB)	20	—	—
Return loss	ANT	2300 to 2500MHz (dB)	10	—	—
	ANT	4900 to 5950MHz (dB)	9	—	—
	LOW	2400 to 2500MHz (dB)	10	—	—
	HIGH	4900 to 5950MHz (dB)	9	—	—
Temperature range	Operating	(°C)	-40	—	+85
	Storage	(°C)	-40	—	+85

• Ta: +25°C

FREQUENCY CHARACTERISTICS

ANT-LOW

S11

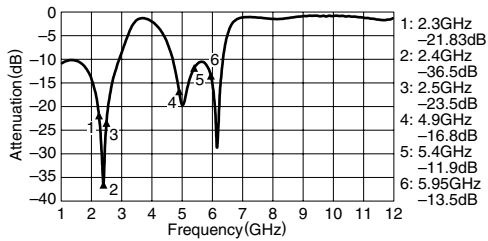

S21

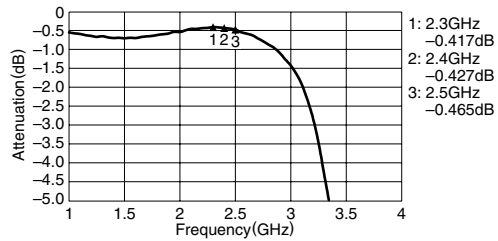

S21

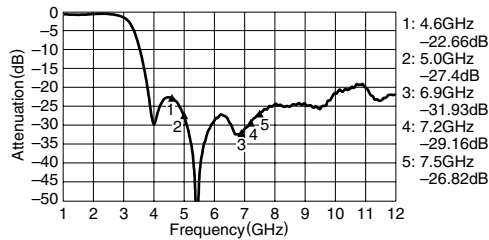

S22

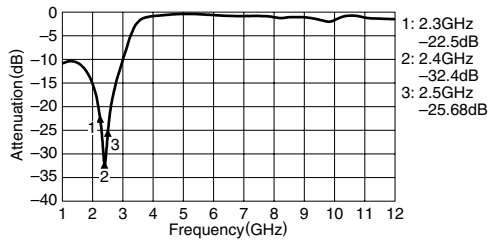

ANT-HIGH

S11

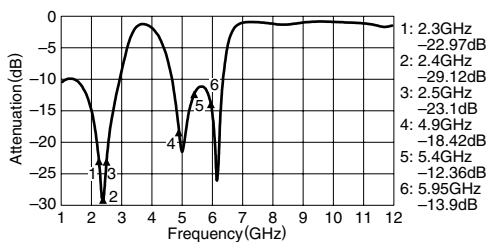

S21

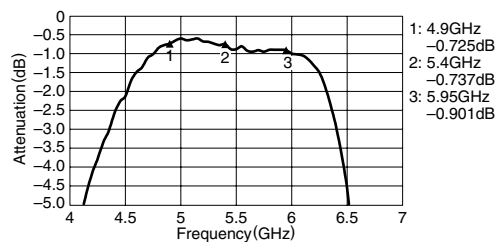

S21

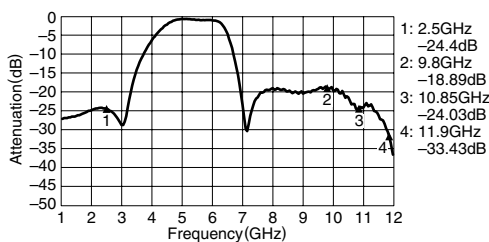

S22

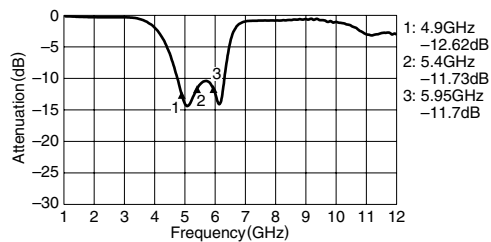

• All specifications are subject to change without notice.

Multilayer Chip Diplexers For 2.4/5GHz W-LAN

Conformity to RoHS Directive

DPX Series DPX205950DT-9108A1

SHAPES AND DIMENSIONS

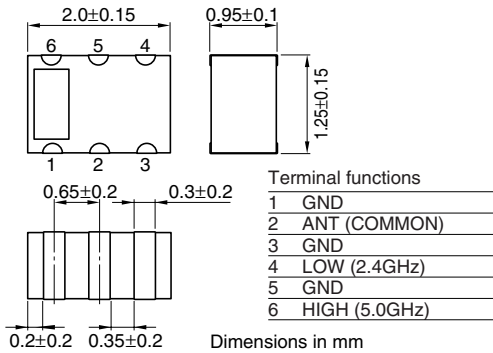

CIRCUIT DIAGRAM

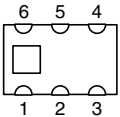

RECOMMENDED PC BOARD PATTERNS

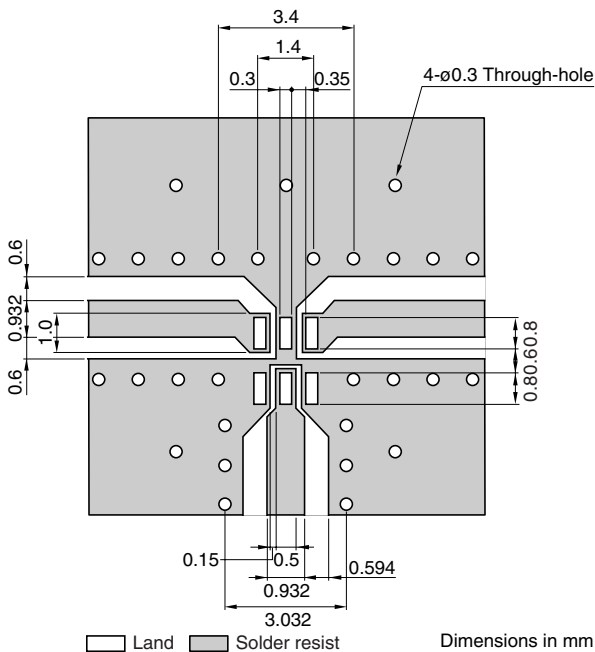

Line width be designed to match 50Ω characteristic impedance depending on PCB material and thickness.

- Conformity to RoHS Directive: This means that, in conformity with EU Directive 2002/95/EC, lead, cadmium, mercury, hexavalent chromium, and specific bromine-based flame retardants, PBB and PBDE, have not been used, except for exempted applications.

- All specifications are subject to change without notice.

ELECTRICAL CHARACTERISTICS

Item	Port	Frequency range	Minimum value	Typical value	Maximum value	
Insertion loss	ANT-LOW	[25±5°C]	2300 to 2500MHz	(dB) —	—	0.65
		[-40 to +85°C]	2300 to 2500MHz	(dB) —	—	0.8
	ANT-HIGH	[25±5°C]	4900 to 5950MHz	(dB) —	—	1.4
						1.6
Attenuation	ANT-LOW	4600 to 5000MHz	(dB) 20	—	—	
		6900 to 7500MHz	(dB) 20	—	—	
	ANT-HIGH	2300 to 2500MHz	(dB) 20	—	—	
		9800 to 11900MHz	(dB) 13	—	—	
Return loss	ANT	2300 to 2500MHz	(dB) 10	—	—	
	ANT	4900 to 5950MHz	(dB) 9	—	—	
	LOW	2400 to 2500MHz	(dB) 10	—	—	
	HIGH	4900 to 5950MHz	(dB) 9	—	—	
Temperature range	Operating	(°C)	-40	—	+85	
	Storage	(°C)	-40	—	+85	

• Ta: +25°C

FREQUENCY CHARACTERISTICS

ANT-LOW

S11

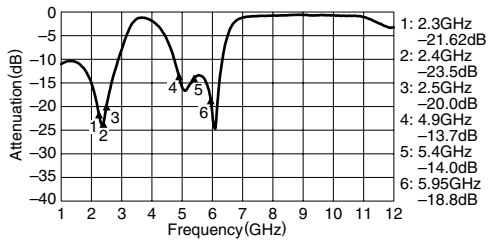

S21

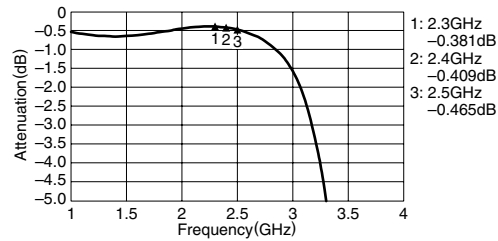

S21

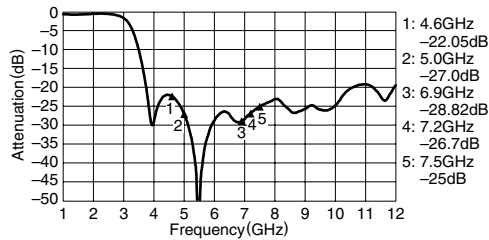

S22

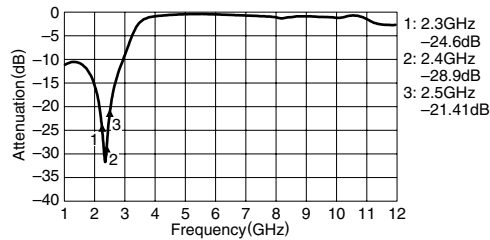

ANT-HIGH

S11

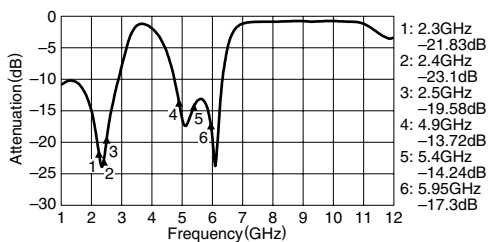

S21

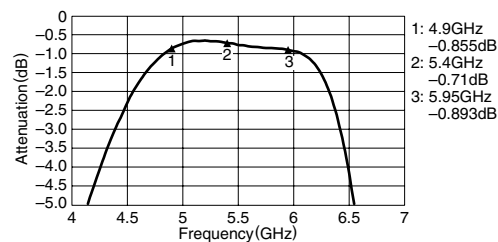

S21

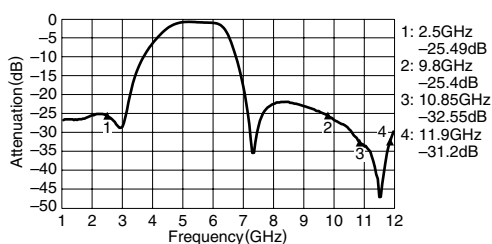

S22

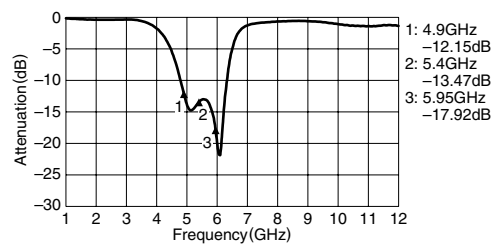

• All specifications are subject to change without notice.