

### Devices Connected/Referenced

AD8318	1 MHz to 8 GHz, 70 dB, Logarithmic Detector/Controller
AD7887	2.7 V to 5.25 V, Micropower, 2-Channel, 125 kSPS, 12-Bit ADC in 8-Lead MSOP
ADR421	Precision, Low Noise, 2.5 V Reference

## Software-Calibrated, 1 MHz to 8 GHz, 60 dB RF Power Measurement System Using a Logarithmic Detector

### EVALUATION AND DESIGN SUPPORT

#### Circuit Evaluation Boards

[CN-0150 Circuit Evaluation Board \(EVAL-CN0150A-SDPZ\) System Demonstration Platform \(EVAL-SDP-CB1Z\)](#)

#### Design and Integration Files

[Schematics](#), [Layout Files](#), [Bill of Materials](#)

### CIRCUIT FUNCTION AND BENEFITS

This circuit measures RF power at any frequency from 1 MHz to 8 GHz over a range of approximately 60 dB. The measurement result is provided as a digital code at the output of a 12-bit ADC with serial interface and integrated reference. The output of the RF detector has a glueless interface to the ADC and uses most of the ADC's input range without further adjustment.

A simple two-point system calibration is performed in the digital domain.

The AD8318 maintains accurate log conformance for signals of 1 MHz to 6 GHz and provides useful operation to 8 GHz. The device provides a typical output voltage temperature stability of  $\pm 0.5$  dB.

The AD7887 ADC can be configured for either dual or single channel operation via the on-chip control register. There is a default single-channel mode that allows the AD7887 to be operated as a read-only ADC, thereby simplifying the control logic.

Typical data is shown for the two devices operating over a  $-40^{\circ}\text{C}$  to  $+85^{\circ}\text{C}$  temperature range.

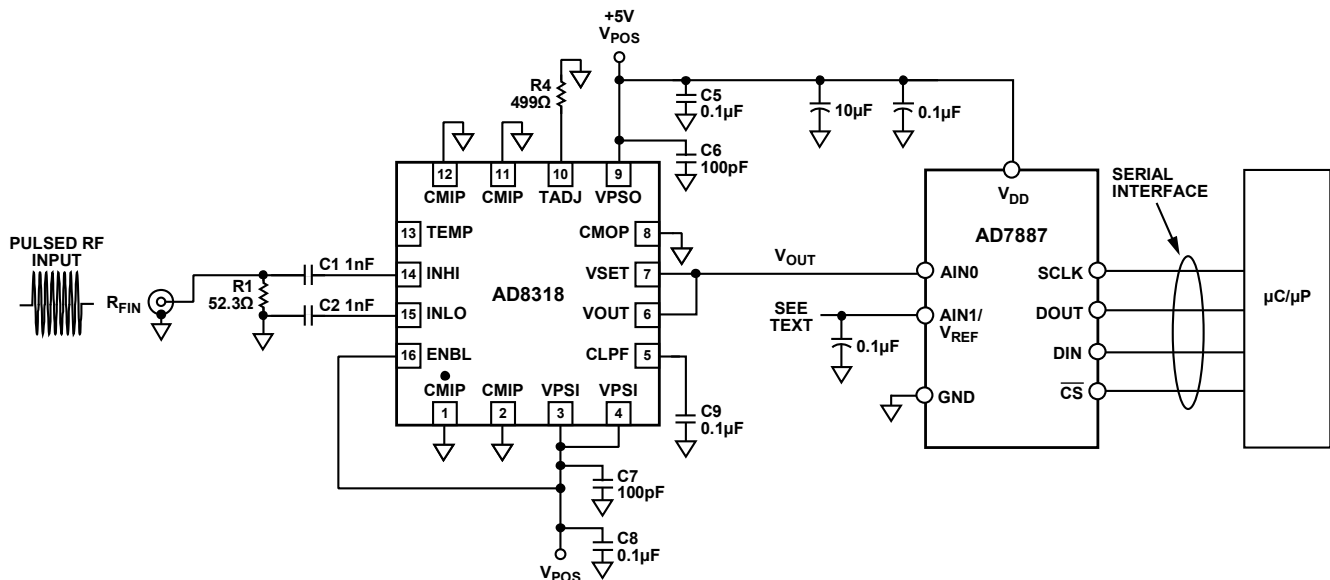

Figure 1. Software-Calibrated RF Measurement System (Simplified Schematic: All Connections Not Shown)

#### Rev. C

Circuits from the Lab™ circuits from Analog Devices have been designed and built by Analog Devices engineers. Standard engineering practices have been employed in the design and construction of each circuit, and their function and performance have been tested and verified in a lab environment at room temperature. However, you are solely responsible for testing the circuit and determining its suitability and applicability for your use and application. Accordingly, in no event shall Analog Devices be liable for direct, indirect, special, incidental, consequential or punitive damages due to any cause whatsoever connected to the use of any Circuits from the Lab circuits. (Continued on last page)

**CIRCUIT DESCRIPTION**

The RF signal being measured is applied to the AD8318. The device is configured in its so-called measurement mode, with the VSET and VOUT pins connected together. In this mode, the output voltage vs. the input signal level is linear-in-dB (nominally -24 mV/dB) and has a typical output voltage range of 0.5 V to 2.1 V.

The AD8318 output is connected directly to the AD7887, 12-bit ADC. The ADC uses its internal reference and is configured for a 0 V to 2.5 V input, resulting in an LSB size of 610 μV. With the RF detector providing a nominal -24 mV/dB, the digital resolution is 39.3 LSBs/dB. With this much resolution, there is little value in trying to scale the 0.5 V to 2.1 V signal from the RF detector to exactly fit the 0 V to 2.5 V range of the ADC.

The transfer function of the detector can be approximated by the equation

$$V_{OUT} = SLOPE \times (P_{IN} - INTERCEPT)$$

where SLOPE is in mV/dB (-24 mV/dB nominal); INTERCEPT is the x-axis intercept with a unit of dBm (20 dBm nominal); and P<sub>IN</sub> is the input power expressed in dBm. A typical plot of detector output voltage vs. input power is shown in Figure 2.

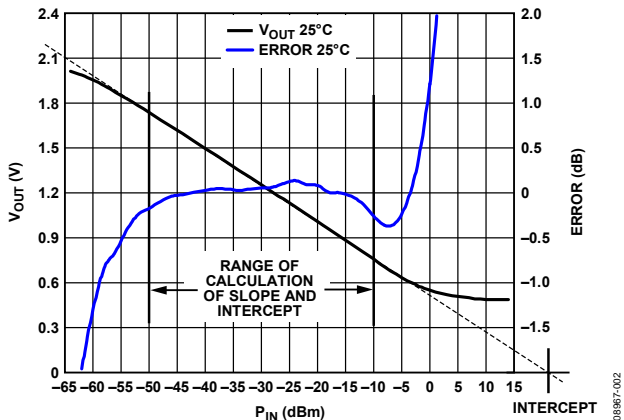

Figure 2. Typical Output Voltage vs. Input Signal Level for the AD8318

At the output of the ADC, the equation can be written as

$$CODE\_OUT = SLOPE\_ADC \times (PIN - INTERCEPT)$$

where SLOPE\_ADC is in codes/dB and PIN and INTERCEPT are in dBm. Figure 3 shows a typical detector power sweep in terms of input power and observed ADC codes.

Because the slope and intercept of the system vary from device to device, a system level calibration is required. A calibration is performed by applying two known signal levels close to the endpoints of the AD8318 linear input range and measuring the corresponding output codes from the ADC. The calibration points chosen should be well within the linear operating range of the device (-10 dBm and -50 dBm in this case).

Using the two known input power levels, PIN\_1 and PIN\_2, and the corresponding observed ADC codes, CODE\_1 and CODE\_2, SLOPE\_ADC, and INTERCEPT can be calculated using the following equations:

$$SLOPE\_ADC = (CODE\_2 - CODE\_1)/(PIN\_2 - PIN\_1)$$

$$INTERCEPT = PIN\_2 - (CODE\_2/SLOPE\_ADC)$$

Once SLOPE\_ADC and INTERCEPT are calculated and stored (in nonvolatile RAM) during factory calibration, they can be used to calculate an unknown input power level, PIN, when the equipment is in operation in the field using the equation

$$PIN = (CODE\_OUT/SLOPE\_ADC) + INTERCEPT$$

Figure 3 through Figure 8 show how the system transfer function deviates from this straight line equation, particularly at the endpoints of the transfer function. This deviation is expressed in dB using the equation

$$Error (dB) = Measured Input Power - True Input Power = (CODE\_OUT/SLOPE\_ADC) + INTERCEPT - PIN\_TRUE$$

where:

CODE\_OUT is the ADC output code.

SLOPE\_ADC is the stored ADC slope in codes/dB.

INTERCEPT is the stored intercept.

PIN\_TRUE is the exact (and unknown) input level.

The plots shown in Figure 3 through Figure 8 show the typical system performance that can be obtained using the AD8318 and AD7887BR in an RF power measurement system. The graphs depict the RF input power in dBm vs. the ADC output code and output error in dB (scaled on the axes on the right side of the plots). They were generated from data taken with various input power levels, frequencies, and temperatures and with both internal and external ADC voltage references. The charts show improved system performance and lower temperature drift with the use of a low drift external ADC voltage reference. (See the Common Variations section for more details about the use of an external reference.

A complete design support package for this circuit note can be found at [www.analog.com/CN0150-DesignSupport](http://www.analog.com/CN0150-DesignSupport).

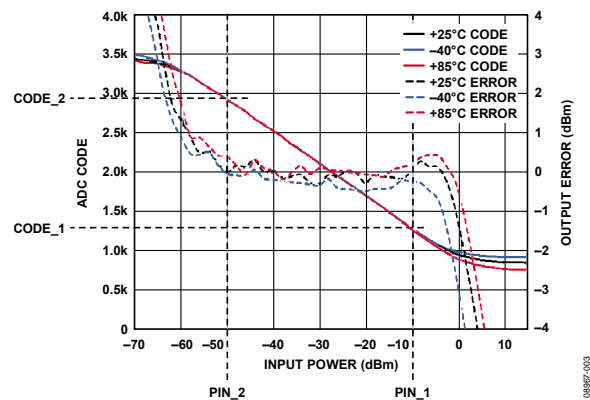

Figure 3. Input = 900 MHz, ADC Using an Internal 2.5 V Reference

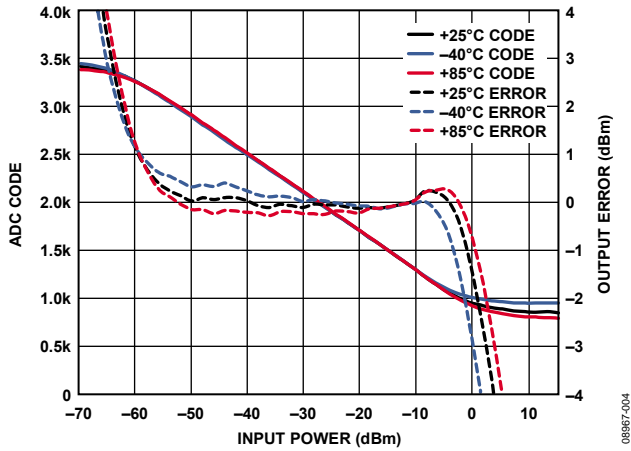

Figure 4. Input = 900 MHz, ADC Using an External 2.5 V Reference

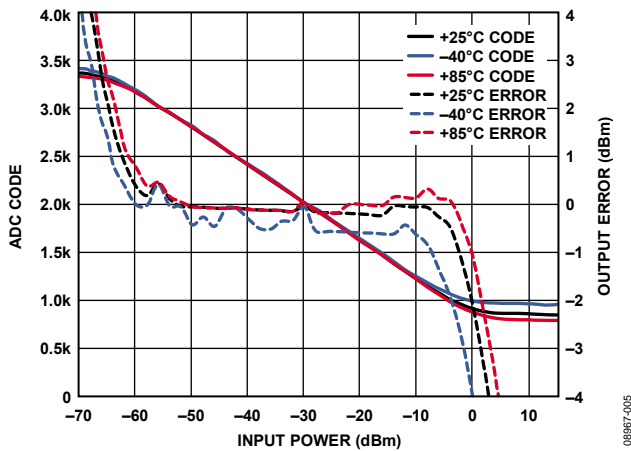

Figure 5. Input = 1.9 GHz, ADC Using an Internal 2.5 V Reference

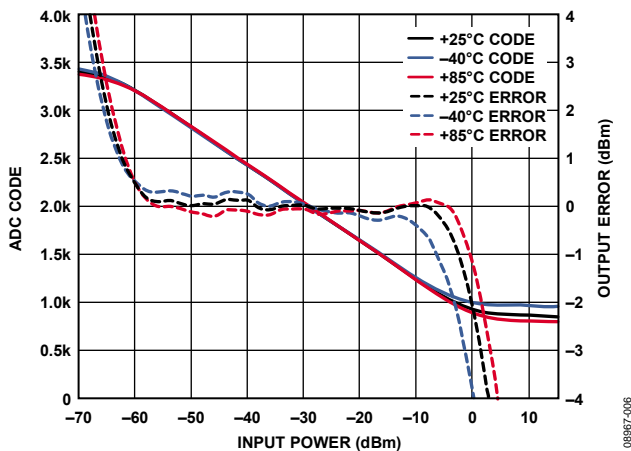

Figure 6. Input = 1.9 GHz, ADC Using an External 2.5 V Reference

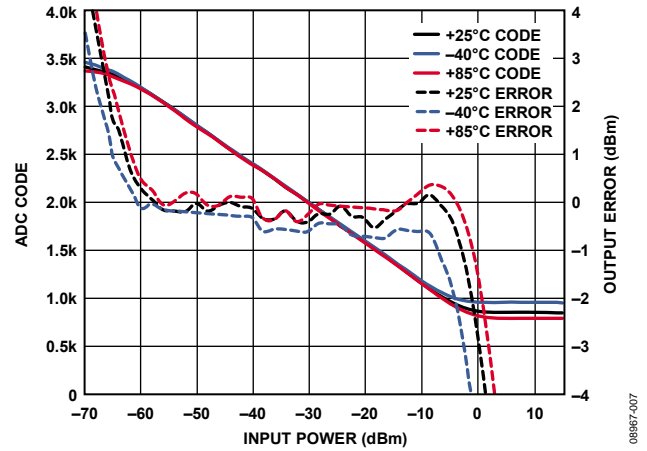

Figure 7. Input = 2.2 GHz, ADC Using an Internal 2.5 V Reference

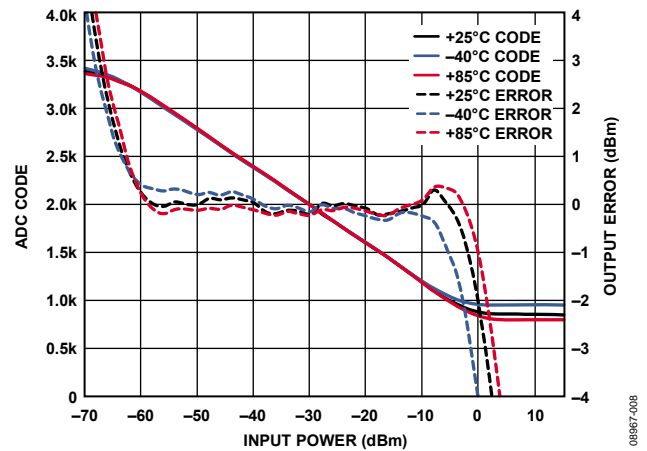

Figure 8. Input = 2.2 GHz, ADC Using an External 2.5 V Reference

### COMMON VARIATIONS

The [AD7887](#) is a 2-channel, 12-bit ADC with an SPI interface. The second input channel of this device can be connected to the [AD8318](#) TEMP pin. This provides a convenient measure of the ambient temperature around the [AD8318](#). Like the [AD8318](#) power measurement output, the TEMP voltage output should also be calibrated.

If the end application requires only a single channel, the 12-bit [AD7495](#) can be used. In multichannel applications that require multiple ADCs and DAC channels, the [AD7294](#) can be used. In addition to providing four 12-bit DAC outputs, this subsystem chip includes four uncommitted ADC channels, two high-side current sense inputs, and three temperature sensors. Current and temperature measurements are digitally converted and available to read over the I<sup>2</sup>C-compatible interface.

The temperature stability of the circuit can be improved using an external ADC reference. The [AD7887](#) internal 2.5 V reference has a 50 ppm/°C drift, which is approximately 15 mV over a 125°C range. Because the detector has a slope of -24 mV/dB, the ADC reference drift contributes approximately ±0.3 dB to the temperature drift error budget. The [AD8318](#) temperature drift is approximately ±0.5 dB over a similar temperature range. (This varies with frequency. See the [AD8318](#) data sheet for more details.)

If an external voltage reference is to be used, the [ADR421](#) 2.5 V reference is recommended. Its 1 ppm/°C temperature drift results in a reference voltage variation of only 312  $\mu$ V from -40°C to +85°C. This has a negligible effect on the overall temperature stability of the system.

If a less dynamic range is required, the [AD8317](#) (55 dB) or [AD8319](#) (45 dB) log detector can be used. If a true rms responding power measurement is required, the [AD8363](#) (50 dB) or [ADL5902](#) (65 dB) can be used.

## CIRCUIT EVALUATION AND TEST

This circuit uses the [EVAL-CN0150A-SDPZ](#) circuit board and the [EVAL-SDP-CB1Z System Demonstration Platform \(SDP\)](#) evaluation board. The two boards have 120-pin mating connectors, allowing for the quick setup and evaluation of the circuit's performance. The [EVAL-CN0150A-SDPZ](#) board contains the circuit to be evaluated, as described in this note, and the SDP evaluation board is used with the CN0150A evaluation software to capture the data from the [EVAL-CN0150A-SDPZ](#) circuit board.

### Equipment Needed

- PC with a USB port and Windows® XP or Windows Vista® (32-bit), or Windows 7 (32-bit)
- [EVAL-CN0150A-SDPZ](#) Circuit Evaluation Board
- [EVAL-SDP-CB1Z SDP](#) Evaluation Board
- CN0150A Evaluation Software
- Power supply: 6 V or 6 V wall wart
- Environmental chamber
- RF signal source
- Coaxial RF cable with SMA connectors

### Getting Started

Load the evaluation software by placing the CN0150A evaluation software CD in the CD drive of the PC. Using **My Computer**, locate the drive that contains the evaluation software CD and open the readme file. Follow the instructions contained in the readme file for installing and using the evaluation software.

### Functional Block Diagram

See Figure 1 of this circuit note for the circuit block diagram and the [EVAL-CN150A-SDPZ-SCH-Rev0.pdf](#) file for the circuit schematics. This file is contained in the [CN0150 Design Support Package](#).

### Setup

Connect the 120-pin connector on the [EVAL-CN0150A-SDPZ](#) circuit board to the CON A connector on the [EVAL-SDP-CB1Z](#) evaluation (SDP) board. Use nylon hardware to firmly secure the two boards, using the holes provided at the ends of the 120-pin connectors. Using an appropriate RF cable, connect the RF signal source to the [EVAL-CN0150A-SDPZ](#) board via the SMA RF input connector. With power to the supply off, connect a 6 V power supply to the +6V and GND pins on the board. If available, a

6 V wall wart can be connected to the barrel connector on the board and used in place of the 6 V power supply. Connect the USB cable supplied with the SDP board to the USB port on the PC. Note: Do not connect the USB cable to the mini USB connector on the SDP board at this time.

### Test

Apply power to the 6 V supply (or wall wart) connected to [EVAL-CN0150A-SDPZ](#) circuit board. Launch the evaluation software and connect the USB cable from the PC to the USB mini connector on the SDP board.

Once USB communications are established, the SDP board can now be used to send, receive, and capture serial data from the [EVAL-CN0150A-SDPZ](#) board.

The data in this circuit note were generated using a Rohde & Schwarz SMT-03 RF signal source and an Agilent E3631A power supply. The signal source was set to the frequencies indicated in the graphs, and the input power was stepped and data recorded in 1 dB increments.

Temperature testing was performed using a Test Equity Model 107 environmental chamber. The [EVAL-CN0150A-SDPZ](#) evaluation board was placed in the chamber via a slot in the test chamber door, with the SDP evaluation board extending outside.

Information and details regarding how to use the evaluation software for data capture can be found in the CN0150A evaluation software readme file.

Information regarding the SDP board can be found in the [SDP User Guide](#).

## LEARN MORE

CN0150 Design Support Package:

<http://www.analog.com/CN0150-DesignSupport>

SDP User Guide

MT-031 Tutorial, *Grounding Data Converters and Solving the Mystery of "AGND" and "DGND,"* Analog Devices.

MT-077 Tutorial, *Log Amp Basics,* Analog Devices.

MT-078 Tutorial, *High Speed Log Amps,* Analog Devices.

MT-101 Tutorial, *Decoupling Techniques,* Analog Devices.

Whitlow, Dana. *Design and Operation of Automatic Gain Control Loops for Receivers in Modern Communications Systems.* Chapter 8. Analog Devices Wireless Seminar. 2006.

### Data Sheets and Evaluation Boards

CN-0150 Circuit Evaluation Board ([EVAL-CN0150A-SDPZ](#))

System Demonstration Platform ([EVAL-SDP-CB1Z](#))

[AD7887 Data Sheet](#)

[AD7887 Evaluation Board](#)

[AD8318 Data Sheet](#)

[AD8318 Evaluation Board](#)

[ADR421 Data Sheet](#)

**REVISION HISTORY****2/12—Rev. B to Rev. C**

Changed 70 dB to 60 dB in Circuit Note Title ..... 1

**3/11—Rev. A to Rev. B**

Added Evaluation and Design Support Section ..... 1

Added Circuit Evaluation and Test Section ..... 4

**8/10— Rev. 0 to Rev. A**

Changes to the Circuit Function and Benefits Section ..... 1

Changes to the Circuit Description Section ..... 2

Changes to the Common Variations Section ..... 4

**4/10—Revision 0: Initial Version**

I<sup>2</sup>C refers to a communications protocol originally developed by Philips Semiconductors (now NXP Semiconductors).

(Continued from first page) Circuits from the Lab circuits are intended only for use with Analog Devices products and are the intellectual property of Analog Devices or its licensors. While you may use the Circuits from the Lab circuits in the design of your product, no other license is granted by implication or otherwise under any patents or other intellectual property by application or use of the Circuits from the Lab circuits. Information furnished by Analog Devices is believed to be accurate and reliable. However, Circuits from the Lab circuits are supplied "as is" and without warranties of any kind, express, implied, or statutory including, but not limited to, any implied warranty of merchantability, noninfringement or fitness for a particular purpose and no responsibility is assumed by Analog Devices for their use, nor for any infringements of patents or other rights of third parties that may result from their use. Analog Devices reserves the right to change any Circuits from the Lab circuits at any time without notice but is under no obligation to do so.

©2010–2012 Analog Devices, Inc. All rights reserved. Trademarks and registered trademarks are the property of their respective owners.  
CN08967-0-2/12(C)



[www.analog.com](http://www.analog.com)