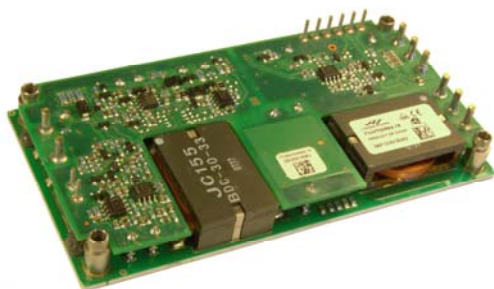


**FNW700R Series Power Modules; DC-DC Converters**  
**36-75Vdc Input; 28Vdc, 700W Output**

---



### Applications

- RF Power Amplifier
- Wireless Networks
- Switching Networks

### Options

- Output OCP/OVP auto restart
- Shorter pins
- Unthreaded heatsink holes

### Description

The FNW700R series of dc-dc converters are a new generation of isolated DC/DC power modules providing up to 700W output power in an industry standard full size brick footprint, which makes it an ideal choice for high voltage and high power applications. Threaded-through holes are provided to allow easy mounting or addition of a heatsink for high-temperature applications. The output is fully isolated from the input, allowing versatile polarity configurations and grounding connections

### Features

- High power density: 127 W/in<sup>3</sup>
- Industry standard pin-out
- Low output ripple and noise
- Industry standard Full brick footprint  
116.6mm x 60.7mm x 12.7mm  
(4.6" x 2.4" x 0.5")
- Remote Sense
- 2:1 input voltage range
- Single tightly regulated main output
- Constant switching frequency
- Latch after fault shutdown
- Over temperature protection auto restart
- Loosely regulated auxiliary output
- Power good signal
- Output voltage adjustment trim (+10%/-40%)
- Wide operating case temperature range (-40°C to 100°C)
- CE mark meets 73/23/EEC and 93/68/EEC directives<sup>§</sup>
- UL60950-1/CSA<sup>†</sup> C22.2 No. 60950-1-03 Certified (cCSA<sub>US</sub>) and VDE<sup>‡</sup> 0805:2001-12 (EN60950-1) Licensed
- ISO\*\* 9001 and ISO 14001 certified manufacturing facilities

<sup>§</sup> This product is intended for integration into end use equipment only

<sup>†</sup> CSA is a registered trademark of Canadian Standards Association.

<sup>‡</sup> VDE is a trademark of Verband Deutscher Elektrotechniker e.V.

\*\* ISO is a registered trademark of the International Organization of Standards

## Absolute Maximum Ratings

Stresses in excess of the absolute maximum ratings can cause permanent damage to the device. These are absolute stress ratings only, functional operation of the device is not implied at these or any other conditions in excess of those given in the operations sections of the data sheet. Exposure to absolute maximum ratings for extended periods can adversely affect the device reliability.

Parameter	Device	Symbol	Min	Max	Unit
Input Voltage (Continuous)	All	$V_{IN}$	-0.3	80	$V_{dc}$
Operating Ambient Temperature (See Thermal Considerations section) Note: When the operating ambient temperature is within 55C~85C, the application of the module refers to the derating curves of Figure 15 and Figure 16.	All	$T_A$	-40	85	$^{\circ}C$
Operating Case Temperature (See Thermal Considerations section)	All	$T_C$	-40	100	$^{\circ}C$
Storage Temperature	All	$T_{stg}$	-55	125	$^{\circ}C$
I/O Isolation Voltage, input to case	All	—	—	1500	$V_{dc}$
Output to case	All	—	—	500	$V_{dc}$

## Electrical Specifications

Unless otherwise indicated, specifications apply over all operating input voltage, resistive load, and temperature conditions.

Parameter	Device	Symbol	Min	Typ	Max	Unit
Operating Input Voltage	All	$V_{IN}$	36	48	75	$V_{dc}$
Maximum Input Current ( $V_{IN}=36V$ to $75V$ , $I_O=I_{O,max}$ )	All	$I_{IN,max}$			23	$A_{dc}$
Inrush Transient	All	$I^2t$			2	$A^2s$
Input Reflected Ripple Current, peak-to-peak (5Hz to 20MHz, 12 $\mu$ H source impedance; $V_{IN}=0V$ to 75V, $I_O=I_{O,max}$ ; see Figure 10)	All				40	$mA_{p-p}$
Input Ripple Rejection (120Hz)	All			60		dB

### **CAUTION: This power module is not internally fused. An input line fuse must always be used.**

This power module can be used in a wide variety of applications, ranging from simple standalone operation to being an integrated part of complex power architecture. To preserve maximum flexibility, internal fusing is not included. Always use an input line fuse, to achieve maximum safety and system protection. The safety agencies require a fast-acting fuse with a maximum rating of 30A (see Safety Considerations section). Based on the information provided in this data sheet on inrush energy and maximum dc input current, the same type of fuse with a lower rating can be used. Refer to the fuse manufacturer's data sheet for further information.

**Electrical Specifications** (continued)

Parameter	Device	Symbol	Min	Typ	Max	Unit
Output Voltage Set-point ( $V_{IN}=V_{IN,nom}$ , $I_O=I_{O,max}$ , $T_c=25^\circ\text{C}$ )	All	$V_{O,set}$	27.5	28	28.5	V <sub>dc</sub>
Output Voltage (Over all operating input voltage, resistive load, and temperature conditions until end of life)	All	$V_O$	27.15	—	28.85	V <sub>dc</sub>
Output Regulation						
Line ( $V_{IN}=V_{IN,min}$ to $V_{IN,max}$ )	All		—	0.05	0.2	% $V_O$
Load ( $I_O=I_{O,min}$ to $I_{O,max}$ )	All		—	0.05	0.2	% $V_O$
Temperature ( $T_c = -40^\circ\text{C}$ to $+100^\circ\text{C}$ )	All		—	100	300	mV
Output Ripple and Noise on nominal output ( $V_{IN}=V_{IN,nom}$ and $I_O=I_{O,min}$ to $I_{O,max}$ )						
RMS (5Hz to 20MHz bandwidth)	All		—		80	mV <sub>rms</sub>
Peak-to-Peak (5Hz to 20MHz bandwidth)	All		—		300	mV <sub>pk-pk</sub>
External Capacitance Note: use a minimum 470uF output capacitor. If the ambient temperature is less than $-20^\circ\text{C}$ , use more than 3 of recommended minimum capacitors.	All	$C_{O,max}$	470	1000	5000	$\mu\text{F}$
Output Current	All	$I_O$	2		25	A <sub>dc</sub>
Output Current Limit Inception	All	$I_{O,lim}$	26	29	32	A <sub>dc</sub>
Efficiency $V_{IN}=V_{IN,nom}$ , $T_c=25^\circ\text{C}$ $I_O=I_{O,max}$ , $V_O=V_{O,set}$	All	$\eta$	—	90	—	%
Switching Frequency		$f_{sw}$	—	300	—	kHz
Dynamic Load Response  ( $\Delta I_O/\Delta t=1\text{A}/10\mu\text{s}$ ; $V_{in}=V_{in,nom}$ ; $T_c=25^\circ\text{C}$ ; Tested with a 470 $\mu\text{F}$ aluminum and a 10 $\mu\text{F}$ ceramic capacitor across the load.)						
Load Change from $I_O=50\%$ to $75\%$ of $I_{O,max}$ : Peak Deviation	All	$V_{pk}$	—	3	—	% $V_{O,set}$
Settling Time ( $V_O<10\%$ peak deviation)		$t_s$	—	2	—	ms
Load Change from $I_O=75\%$ to $50\%$ of $I_{O,max}$ : Peak Deviation		$V_{pk}$	—	3	—	% $V_{O,set}$
Settling Time ( $V_O<10\%$ peak deviation)		$t_s$	—	2	—	ms

**Isolation Specifications**

Parameter	Symbol	Min	Typ	Max	Unit
Isolation Capacitance	$C_{iso}$	—	1500	—	pF
Isolation Resistance	$R_{iso}$	10	—	—	M $\Omega$

**General Specifications**

Parameter	Device	Symbol	Min	Typ	Max	Unit
Calculated Reliability based upon Telcordia SR-332 Issue 2: Method I Case 3 ( $I_O=80\%I_{O,max}$ , $T_A=40^\circ\text{C}$ , airflow = 200 lfm, 90% confidence)	All	FIT		405.4		$10^9$ /Hours
		MTBF		2,466,797		Hours
Weight	All		—	150 (5.3)	—	g (oz.)

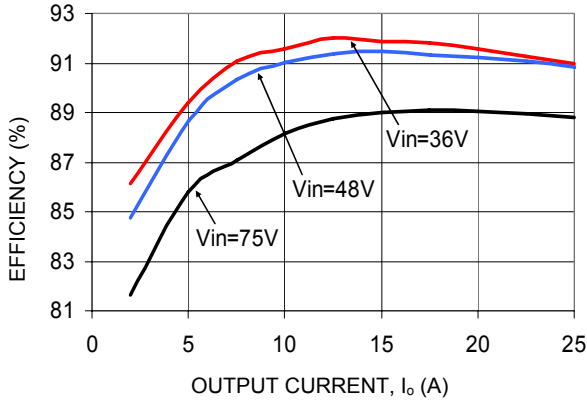
## Feature Specifications

Unless otherwise indicated, specifications apply over all operating input voltage, resistive load, and temperature conditions. See Feature Descriptions for additional information.

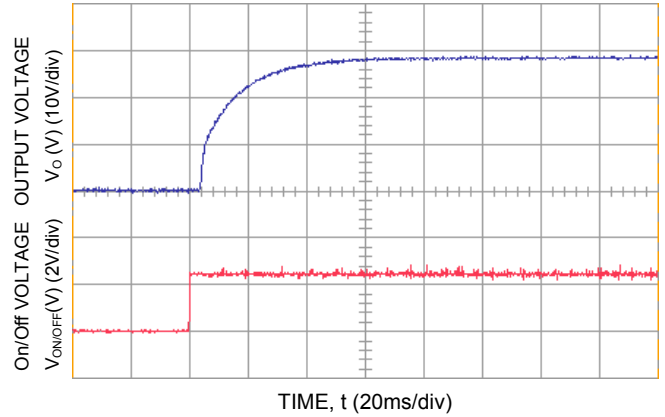
Parameter	Device	Symbol	Min	Typ	Max	Unit
Remote On/Off Signal Interface ( $V_{IN}=V_{IN, min}$ to $V_{IN, max}$ ; open collector or equivalent), Refer to remote on/off description and Figure 11.						
Remote On/Off Current – Logic ON	All	$I_{on/off}$	1.0	—	5.0	mA
Remote On/Off Current – Logic OFF	All	$I_{on/off}$	—	—	50	$\mu$ A
Turn-On Delay and Rise Times ( $V_{IN}=V_{IN, nom}$ , $I_O=I_{O, max}$ , 25C)						
Case 1: On/Off input is set to Logic Low (Module ON) and then input power is applied ( $T_{delay}$ from instant at which $V_{IN} = V_{IN, min}$ until $V_O=10\%$ of $V_{O, set}$ )	All	$T_{delay}$	60	75	100	ms
Case 2: Input power is applied for at least 1 second and then the On/Off input is set from OFF to ON ( $T_{delay} =$ from instant at which $V_{IN}=V_{IN, min}$ until $V_O = 10\%$ of $V_{O, set}$ ).	All	$T_{delay}$	—	5	—	ms
$T_{rise} =$ time for $V_O$ to rise from 10% of $V_{O, set}$ to 90% of $V_{O, set}$ .	All	$T_{rise}$	—	25	—	ms
Output Voltage Overshoot ( $I_O=80\%$ of $I_{O, max}$ , $T_A=25^\circ$ C)					3	% $V_{O, set}$
Output Voltage Adjustment (See Feature Descriptions):						
Output Voltage Remote-sense Range (only for No Trim or Trim down application )	All	$V_{sense}$	—	—	2	% $V_{O, nom}$
Output Voltage Set-point Adjustment Range (trim)	All	$V_{trim}$	60	—	110	% $V_{O, nom}$
Output Overvoltage Protection	All	$V_{O, limit}$	32	—	38	V
Over Temperature Protection (See Feature Descriptions)	All	$T_{ref}$	—	106	—	$^\circ$ C
Input Under Voltage Lockout		$V_{IN, UVLO}$				
Turn-on Threshold	All			35	36	$V_{dc}$
Turn-off Threshold	All		30	31		$V_{dc}$
Hysteresis	All			4		$V_{dc}$
Input Over voltage Lockout		$V_{IN, OVLO}$				
Turn-on Threshold	All		—	76	78	$V_{dc}$
Turn-off Threshold	All		79	80	—	$V_{dc}$
Hysteresis	All		---	4	---	$V_{dc}$

### Characteristic Curves

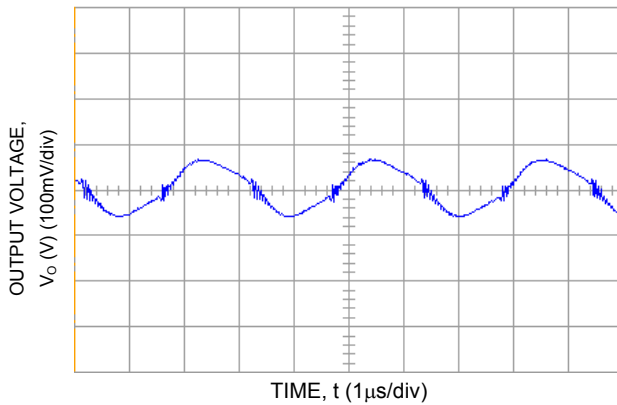
The following figures provide typical characteristics for the FNW700R (28V, 25A) at 25°C. The figures are identical for either positive or negative Remote On/Off logic.



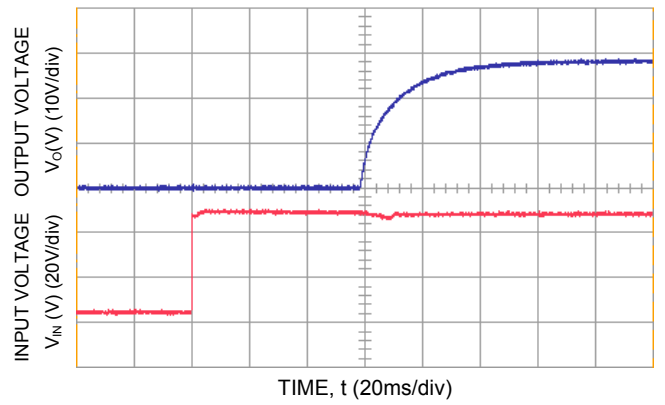
**Figure 1. Converter Efficiency versus Output Current.**



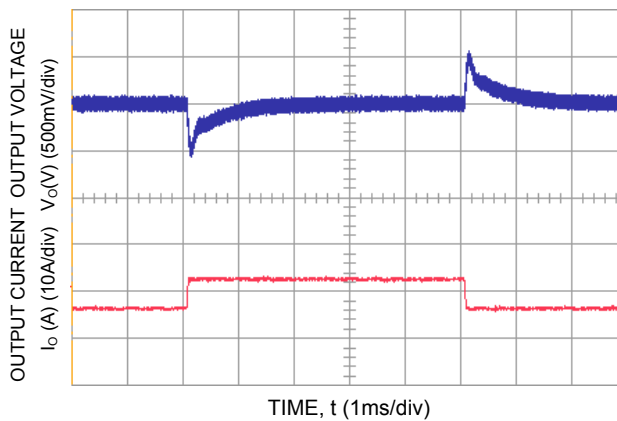
**Figure 4. Typical Start-Up Using Remote On/Off, R1=30Kohm; C<sub>o,ext</sub> = 470µF.**



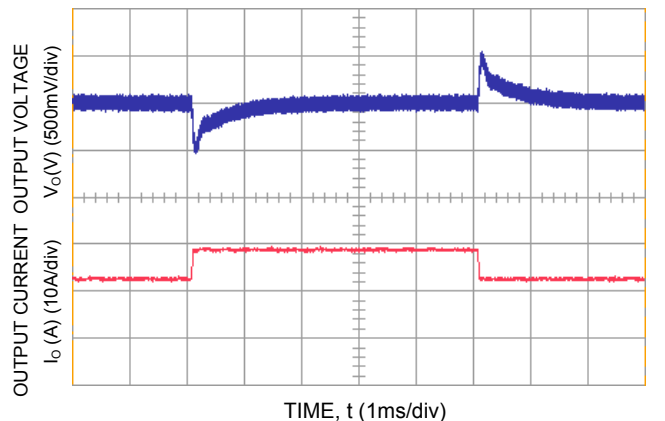
**Figure 2. Typical Output Ripple and Noise at Room Temperature and 48Vin; I<sub>o</sub> = I<sub>o,max</sub>; C<sub>o,ext</sub> = 470µF.**



**Figure 5. Typical Start-Up Using from V<sub>IN</sub>, positive logic version shown; C<sub>o,ext</sub> = 470µF.**

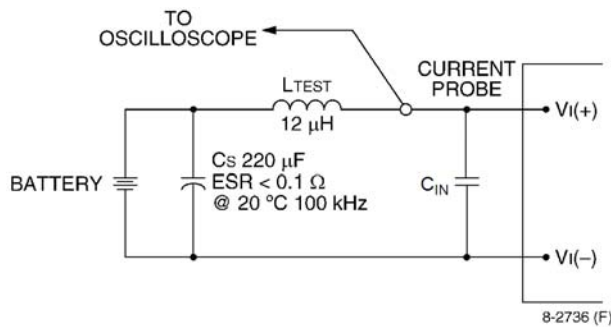


**Figure 3. Transient Response to Dynamic Load Change from 25% to 50% to 25% of Full Load at Room Temperature and 48 Vdc Input; 0.1A/uS ; C<sub>o,ext</sub> = 470µF.**



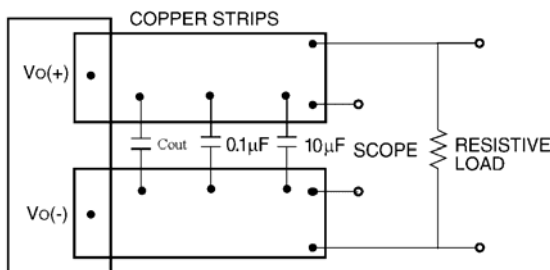
**Figure 6. Transient Response to Dynamic Load Change from 50% to 75% to 50% of Full Load at Room Temperature and 48 Vdc Input; 0.1A/uS ; C<sub>o,ext</sub> = 470µF.**

## Test Configurations



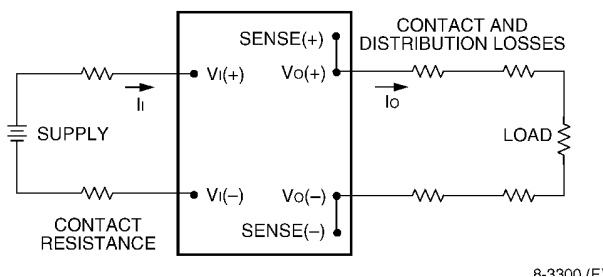
Note: Measure the input reflected-ripple current with a simulated source inductance ( $L_{TEST}$ ) of 12  $\mu\text{H}$ . Capacitor  $C_S$  offsets possible battery impedance. Measure the current, as shown above.

**Figure 7. Input Reflected Ripple Current Test Setup.**



Note: Use a  $C_{out}$  (470  $\mu\text{F}$  Low ESR aluminum or tantalum capacitor typical), a 0.1  $\mu\text{F}$  ceramic capacitor and a 10  $\mu\text{F}$  ceramic capacitor, and Scope measurement should be made using a BNC socket. Position the load between 51 mm and 76 mm (2 in. and 3 in.) from the module.

**Figure 8. Output Ripple and Noise Test Setup.**



Note: All measurements are taken at the module terminals. When socketing, place Kelvin connections at module terminals to avoid measurement errors due to socket contact resistance.

$$\eta = \left( \frac{[V_{O(+)} - V_{O(-)}]I_{O}}{[V_{I(+)} - V_{I(-)}]I_{I}} \right) \times 100 \%$$

**Figure 9. Output Voltage and Efficiency Test Setup.**

## Design Considerations

### Input Source Impedance

The power module should be connected to a low ac-impedance source. Highly inductive source impedance can affect the stability of the power module. For the test configuration in Figure 7, a 470 $\mu\text{F}$  Low ESR aluminum capacitor,  $C_{IN}$ , mounted close to the power module helps ensure the stability of the unit. Consult the factory for further application guidelines.

### Output Capacitance

The FNW700R power module requires a minimum output capacitance of 470 $\mu\text{F}$  Low ESR aluminum capacitor,  $C_{out}$  to ensure stable operation over the full range of load and line conditions, see Figure 8. If the ambient temperature is under  $-20^{\circ}\text{C}$ , it is required to use at least 3 of the minimum capacitors in parallel. In general, the process of determining the acceptable values of output capacitance and ESR is complex and is load-dependant.

### Safety Considerations

For safety-agency approval of the system in which the power module is used, the power module must be installed in compliance with the spacing and separation requirements of the end-use safety agency standard, i.e., UL60950-1, CSA C22.2 No. 60950-1-03, EN60950-1 and VDE 0805:2001-12.

For end products connected to  $-48\text{V}_{dc}$ , or  $-60\text{V}_{dc}$  nominal DC MAINS (i.e. central office dc battery plant), no further fault testing is required. \*Note:  $-60\text{V}_{dc}$  nominal battery plants are not available in the U.S. or Canada.

For all input voltages, other than DC MAINS, where the input voltage is less than  $60\text{V}_{dc}$ , if the input meets all of the requirements for SELV, then:

- The output may be considered SELV. Output voltages will remain within SELV limits even with internally-generated non-SELV voltages. Single component failure and fault tests were performed in the power converters.
- One pole of the input and one pole of the output are to be grounded, or both circuits are to be kept floating, to maintain the output voltage to ground voltage within ELV or SELV limits. However, SELV will not be maintained if  $V_{I(+)}$  and  $V_{O(+)}$  are grounded simultaneously.

## Safety Considerations (continued)

For all input sources, other than DC MAINS, where the input voltage is between 60 and 75V<sub>dc</sub> (Classified as TNV-2 in Europe), the following must be met, if the converter's output is to be evaluated for SELV:

- The input source is to be provided with reinforced insulation from any hazardous voltage, including the ac mains.
- One V<sub>I</sub> pin and one V<sub>O</sub> pin are to be reliably earthed, or both the input and output pins are to be kept floating.
- Another SELV reliability test is conducted on the whole system, as required by the safety agencies, on the combination of supply source and the subject module to verify that under a single fault, hazardous voltages do not appear at the module's output.

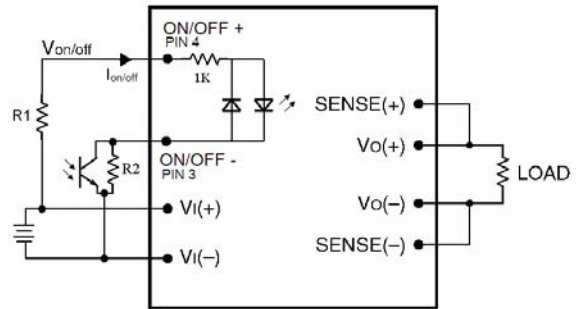
All flammable materials used in the manufacturing of these modules are rated 94V-0, or tested to the UL60950 A.2 for reduced thickness.

The input to these units is to be provided with a maximum 30 A fast-acting fuse in the unearthed lead.

## Feature Description

### Remote On/Off

Remote ON/OFF control is available as standard and has positive logic remote On/Off mode only. The converter will be active as long as a current I<sub>on/off</sub> (1 to 5mA) is flowing into the ON/OFF+ (pin 4) and from the ON/OFF- (pin 3), and inactive when no current is flowing. Remote control pins are isolated up to 1.5 kV. The voltage to drive this current can be derived from the input voltage, the output voltage, or an external supply with an appropriate current limit resistor. The maximum forward current allowable without damage is 5 mA, and the maximum reverse current is 10mA. A typical remote ON/OFF circuit is shown as Figure 10. The current limit resistor (R1) is connected from Vin (+) pin to ON/OFF + pin, an open collector or an equivalent switch can be connected between ON/OFF - and V<sub>I</sub> (-) pins to control ON/OFF operation. A 0 Ohm resistor (R2) can be used if no open collector or switch used. For 48Vin, an appropriate R1 value is recommended to be 30Kohm (0.5W).



**Figure 10. Circuit configuration for using Remote On/Off Implementation.**

### Overcurrent Protection

To provide protection in a fault output overload condition, the module is equipped with internal current-limiting circuitry and can endure current limit for few milli-seconds. A latching shutdown option is standard. If overcurrent persists for few milli-seconds, the module will shut down and remain off until the module is reset by either cycling the input power or by toggling the on/off pin for one second.

An auto-restart option (4) is also available in a case where an auto recovery is required. If overcurrent persists for few milli-seconds, the module will shut down and auto restart until the fault condition is corrected. If the output overload condition still exists when the module restarts, it will shut down again. This operation will continue indefinitely, until the overcurrent condition is corrected.

### Over Voltage Protection

The output overvoltage protection consists of circuitry that monitors the voltage on the output terminals. If the voltage on the output terminals exceeds the over voltage protection threshold, then the module will shutdown and latch off. The overvoltage latch is reset by either cycling the input power for one second or by toggling the on/off signal for one second. The protection mechanism is such that the unit can continue in this condition until the fault is cleared.

An auto-restart option (4) is also available in a case where an auto recovery is required.

### Output Voltage Programming

Trimming allows the user to increase or decrease the output voltage set point of a module. Trimming down is accomplished by connecting an external resistor between the TRIM pin and the SENSE(-) pin. Trimming up is accomplished by connecting external resistor between the SENSE(+) pin and V<sub>O</sub>(+) pin. The trim resistor should be positioned close to the module.

Be sure to use a zero resistor or short SENSE(+) and V<sub>O</sub>(+) pins when the trim up function is not used.

If not using the trim down feature, leave the TRIM pin open.

### Feature Description (continued)

With an external resistor between the TRIM and SENSE(-) pins ( $R_{adj-down}$ ), the output voltage set point ( $V_{o,adj}$ ) decreases (see Figure 11). The following equation determines the required external-resistor value to obtain a percentage output voltage change of  $\Delta\%$ .

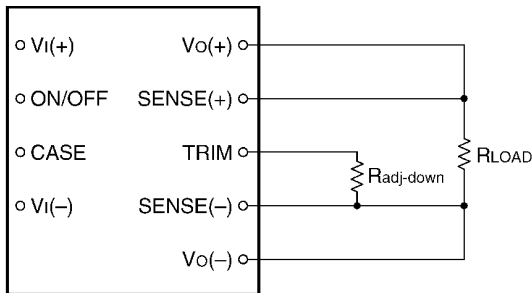
**For output voltages: 28V**

$$R_{adj-down} = 5.97 \times \left( \frac{100}{\Delta\%} - 1 \right) \text{K}\Omega$$

Where,

$$\Delta\% = \left| \frac{V_{o,nom} - V_{desired}}{V_{o,nom}} \right| \times 100$$

$V_{desired}$  = Desired output voltage set point (V).



8-748 (F). b

**Figure 11. Circuit Configuration to Decrease Output Voltage.**

#### Trim Up – Increase Output Voltage

With an external resistor connected between the VO(+) and SENSE(+) pins ( $R_{adj-up}$ ), the output voltage set point ( $V_{o,adj}$ ) increases (see Figure 12).

The following equation determines the required external-resistor value to obtain a percentage output voltage change of  $\Delta\%$ .

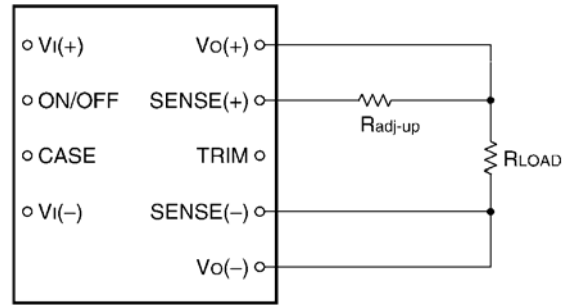
**For output voltages: 28V**

$$R_{adj-up} = \frac{V_{o,nom} \times \Delta\%}{100} \text{K}\Omega$$

Where,

$$\Delta\% = \left| \frac{V_{desired} - V_{o,nom}}{V_{o,nom}} \right| \times 100$$

$V_{desired}$  = Desired output voltage set point (V).



8-715

**Figure 12. Circuit Configuration to Increase Output Voltage.**

The voltage between the VO(+) and VO(-) terminals must not exceed the minimum output overvoltage shut-down value indicated in the Feature Specifications table. This limit includes any increase in voltage due to remote-sense compensation and output voltage set-point adjustment (trim). See Figure 13.

Although the output voltage can be increased by both the remote sense and by the trim, the maximum increase for the output voltage is not the sum of both. The maximum increase is the larger of either the remote sense or the trim.

The amount of power delivered by the module is defined as the voltage at the output terminals multiplied by the output current. When using remote sense and trim, the output voltage of the module can be increased, which the same output current would increase the power output of the module. Care should be taken to ensure that the maximum output power of the module remains at or below the maximum rated power.

#### Examples:

To trim down the output of a nominal 28V module to 16.8V

$$\Delta\% = \left| \frac{28V - 16.8V}{28V} \right| \times 100$$

$$\Delta\% = 40$$

$$R_{adj-down} = 5.97 \times \left( \frac{100}{40} - 1 \right) \text{K}\Omega$$

$$R_{adj-down} = 8.96 \text{ k}\Omega$$

To trim up the output of a nominal 28V module to 30.8V

$$\Delta\% = \left| \frac{30.8V - 28V}{28V} \right| \times 100$$

$$\Delta\% = 10$$

$$R_{adj-up} = \frac{28 \times 10}{100} \text{K}\Omega$$

$$R_{adj-up} = 2.8 \text{ K}\Omega$$



## Feature Description (continued)

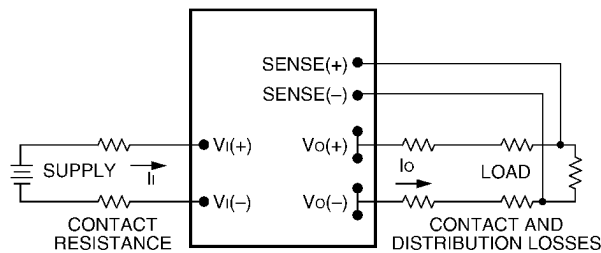
### Remote sense

Remote sense minimizes the effects of distribution losses by regulating the voltage at the remote-sense connections (see Figure 13). For No Trim or Trim down application, the voltage between the remote-sense pins and the output terminals must not exceed the output voltage sense range given in the Feature Specifications table i.e.:

$$[V_o(+)-V_o(-)] - [SENSE(+)-SENSE(-)] \leq 2\% \text{ of } V_{o,nom}$$

The voltage between the Vo(+) and Vo(-) terminals must not exceed the minimum output overvoltage shut-down value indicated in the Feature Specifications table. This limit includes any increase in voltage due to remote-sense compensation and output voltage set-point adjustment (trim). See Figure 13. If not using the remote-sense feature to regulate the output at the point of load, then connect SENSE(+) to Vo(+) and SENSE(-) to Vo(-) at the module.

Although the output voltage can be increased by both the remote sense and by the trim, the maximum increase for the output voltage is not the sum of both. The maximum increase is the larger of either the remote sense or the trim. The amount of power delivered by the module is defined as the voltage at the output terminals multiplied by the output current. When using remote sense and trim: the output voltage of the module can be increased, which at the same output current would increase the power output of the module. Care should be taken to ensure that the maximum output power of the module remains at or below the maximum rated power.



**Figure 13. Effective Circuit Configuration for Single-Module Remote-Sense Operation Output Voltage.**

### Over Temperature Protection

The FNW700R module provides with non-latching over temperature protection. A temperature sensor monitors the operating temperature of the converter. If the reference temperature exceeds a threshold of 106 °C (typical) at the center of the baseplate, the converter will shut down and disable the output. When the baseplate temperature has decreased by approximately 20 °C the converter will automatically restart.

The module can be restarted by cycling the dc input power for at least one second or by toggling the remote on/off signal for at least one second.

### Auxiliary Power Output

The module has an auxiliary power output, available on pin 16, referenced to the Sense- pin. The output is derived from the internal secondary bias supply and is capable of delivering up to 15 mA, with a voltage range that varies between 9V<sub>dc</sub> and 13 V<sub>dc</sub>. This supply is typically used to drive LEDs. To prevent internal module damage, do not connect or short this pin to any other pin on the module.

### Power Good Signal

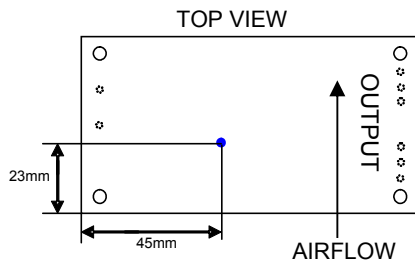
The module contains a power good signal on pin 15, consisting of an open collector circuit that is referenced to the Sense- pin on the secondary side of the module. The power good signal is active low, when the module is operating normally. The maximum current that can sink at this pin, during normal operation active low, is 35 mA<sub>dc</sub>, and the maximum voltage allowed on the pin, during module abnormal operation active high, is 35V<sub>dc</sub>. During transient load changes or during overcurrent hiccup events, the sanity of the power good signal is not guaranteed.

### Thermal Considerations

The power modules operate in a variety of thermal environments; however, sufficient cooling should be provided to help ensure reliable operation of the unit. Heat-dissipating components inside the unit are thermally coupled to the case. Heat is removed by conduction, convection, and radiation to the surrounding environment. Proper cooling can be verified by measuring the case temperature. Peak temperature ( $T_C$ ) occurs at the position indicated in Figure 14.

Considerations include ambient temperature, airflow, module power dissipation, and the need for increased reliability. A reduction in the operating temperature of the module will result in an increase in reliability. The thermal data presented here is based on physical measurements taken in a wind tunnel.

For reliable operation this temperature should not exceed 100°C.



**Figure 14. Case ( $T_C$ ) Temperature Measurement Location (top view).**

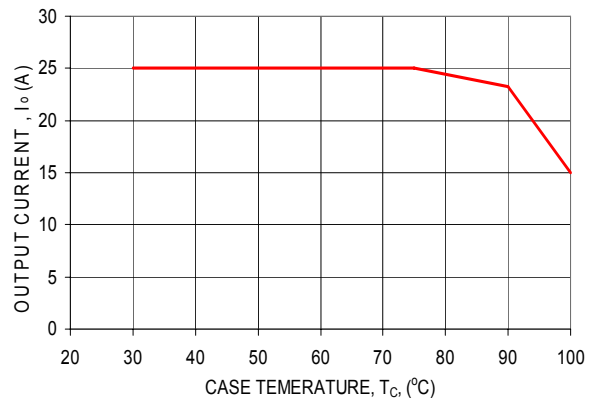
The output power of the module should not exceed the rated power for the module as listed in the ordering information table.

Although the maximum  $T_C$  temperature of the power modules is 100 °C, you can limit this temperature to a lower value for extremely high reliability.

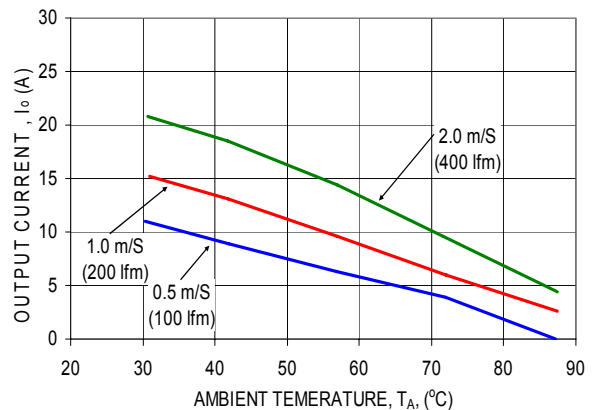
Please refer to the Application Note “Thermal Characterization Process For Open-Frame Board-Mounted Power Modules” for a detailed discussion of thermal aspects including maximum device temperatures.

### Thermal Derating

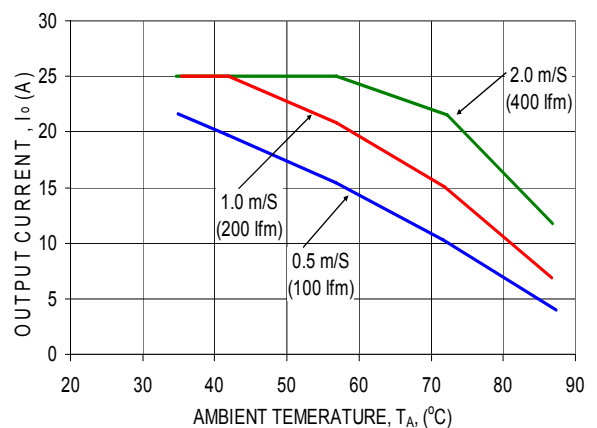
Thermal derating is presented for two different applications: 1) coupled to a cold plate inside a sealed clamshell chassis, without any internal air circulation, and 2) traditional open chassis or cards with force air flow. In application 1, the module is cooled entirely by conduction of heat from the module primarily through the top surface to a coldplate, with some conduction through the module’s pins to the power layers in the system board; for application 2; the module is cooled by heat removal into a forced airflow that passes through the interior of the module and over the top baseplate and/or an attached heatsink.



**Figure 15. Derating Output Current vs. case temperature for FNW700R in conduction cooling (cold plate) applications;  $T_a < 72^\circ\text{C}$  in vicinity of module interior;  $V_{IN} = 48\text{V}$ .**



**Figure 16. Derating Output Current vs. Local Ambient Temperature and Airflow, No Heatsink,  $V_{in} = 48\text{V}$ .**



**Figure 17. Derating Output Current vs. Local Ambient Temperature and Airflow, 1" Transverse Heatsink,  $V_{in} = 48\text{V}$ .**

### Layout Considerations

The FNW700R power module series are aluminum base board packaged style, as such; component clearance between the bottom of the power module and the mounting (Host) board is limited. Avoid placing copper areas on the outer layer directly underneath the power module.

### Post Solder Cleaning and Drying Considerations

Post solder cleaning is usually the final circuit-board assembly process prior to electrical board testing. The result of inadequate cleaning and drying can affect both the reliability of a power module and the testability of the finished circuit-board assembly. For guidance on appropriate soldering, cleaning and drying procedures, refer to Lineage Power *Board Mounted Power Modules: Soldering and Cleaning* Application Note.

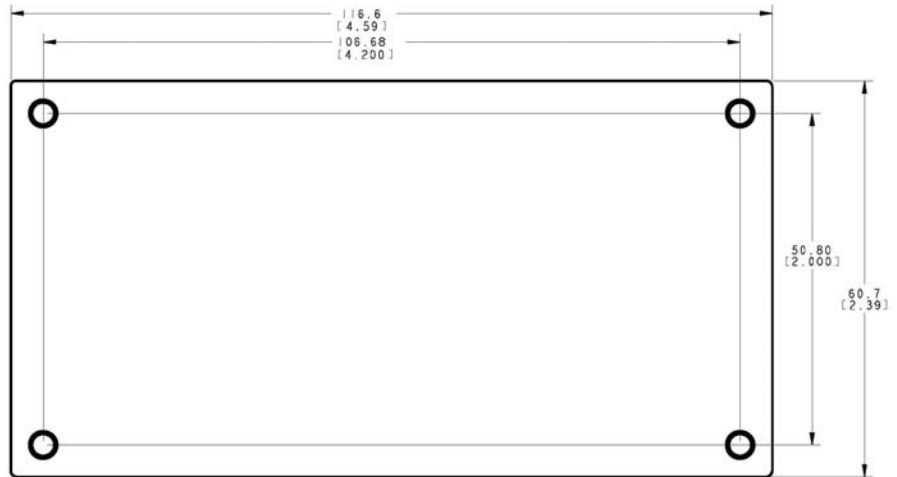
### Mechanical Outline for Through-Hole Module

Dimensions are in millimeters and [inches].

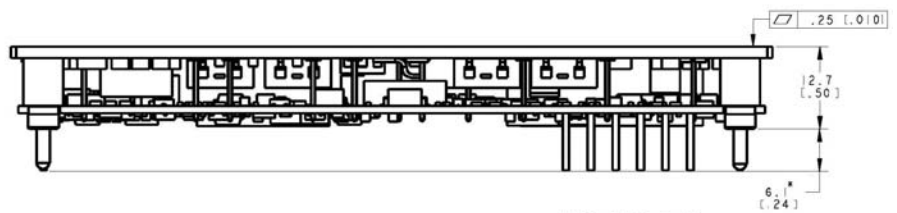
Tolerances: x.x mm ± 0.5 mm [x.xx in. ± 0.02 in.] (unless otherwise indicated)

x.xx mm ± 0.25 mm [x.xxx in ± 0.010 in.]

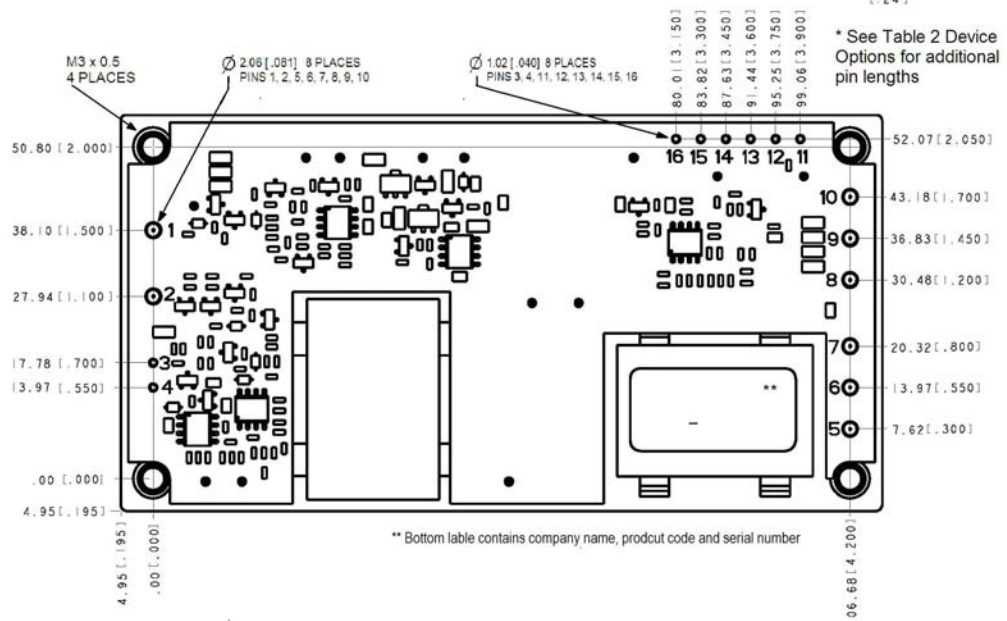
TOP VIEW



SIDE VIEW



BOTTOM VIEW



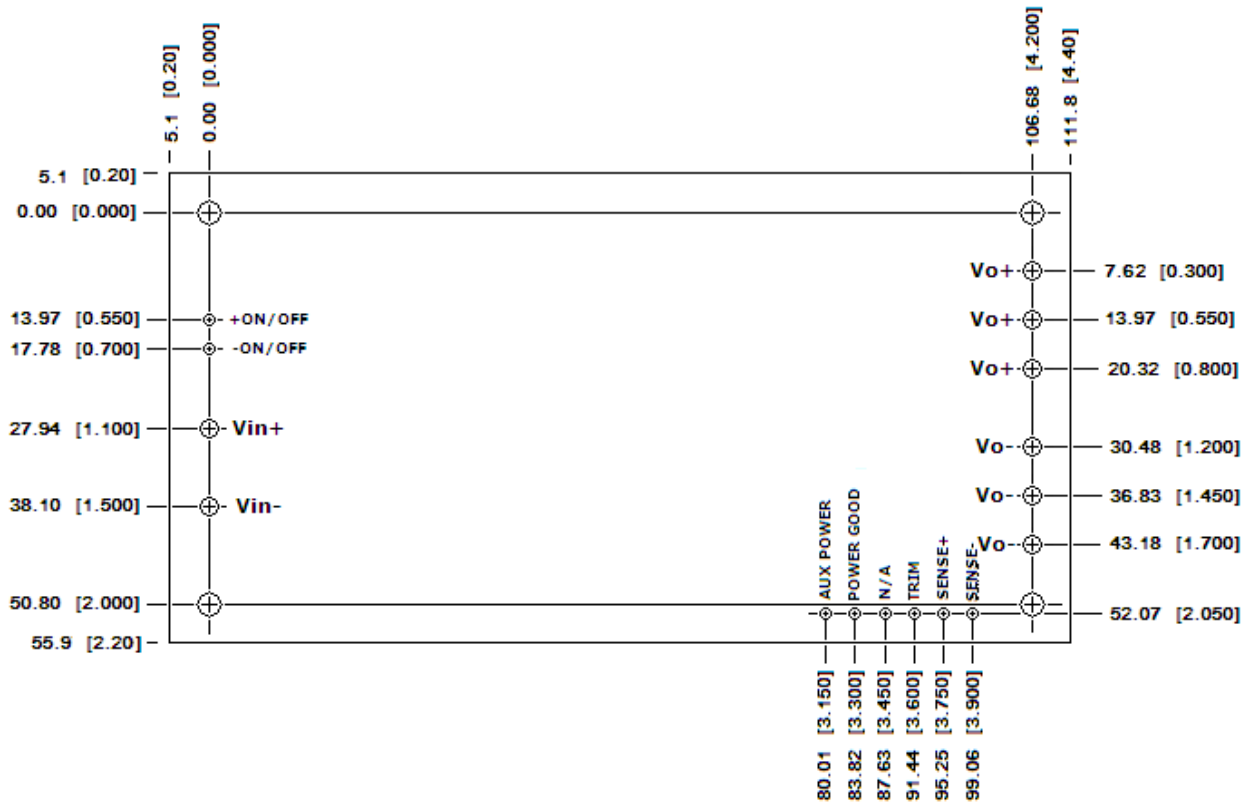
Pin	Description	Pin	Description	Pin	Description	Pin	Description
1	Vin -	5	Vo+	9	Vo-	13	TRIM
2	Vin +	6	Vo+	10	Vo-	14	N/A
3	ON/OFF -	7	Vo+	11	SENSE (-)	15	POWER GOOD
4	ON/OFF +	8	Vo-	12	SENSE (+)	16	AUX POWER

**Recommended Pad Layout for Through Hole Module**

Dimensions are in millimeters and [inches].

Tolerances: x.x mm ± 0.5 mm [x.xx in. ± 0.02 in.] (unless otherwise indicated)

x.xx mm ± 0.25 mm [x.xxx in ± 0.010 in.]



## Ordering Information

Please contact your Lineage Power Sales Representative for pricing, availability and optional features.

**Table 1. Device Code**

Input Voltage	Output Voltage	Output Current	Efficiency	Connector Type	Product codes	Comcodes
48V (36-75Vdc)	28V	25A	90%	Through hole	FNW700R4	CC109141231
48V (36-75Vdc)	28V	25A	90%	Through hole	FNW700R64	CC109145018
48V (36-75Vdc)	28V	25A	90%	Through hole	FNW700R64-18	CC109141396

**Table 2. Device Options**

Option	Device Code Suffix
Auto restart (hiccup) protection	4
Pin Length: 3.68 mm ± 0.25mm , (0.145 in. ± 0.010 in.)	6
Unthreaded heatsink mounting holes	18



**World Wide Headquarters**  
**Lineage Power Corporation**  
3000 Skyline Drive, Mesquite, TX 75149, USA  
**+1-800-526-7819**  
(Outside U.S.A.: **+1-972-284-2626**)  
**www.lineagepower.com**  
**e-mail: techsupport1@lineagepower.com**

**Asia-Pacific Headquarters**  
Tel: +65 6416 4283

**Europe, Middle-East and Africa Headquarters**  
Tel: +49 89 6089 286

**India Headquarters**  
Tel: +91 80 28411633

Lineage Power reserves the right to make changes to the product(s) or information contained herein without notice. No liability is assumed as a result of their use or application. No rights under any patent accompany the sale of any such product(s) or information.

© 2008 Lineage Power Corporation, (Mesquite, Texas) All International Rights Reserved.