

RoHS Compliant Product

## Description

The SMG3314 provide the designer with the best combination of fast switching, low on-resistance and cost-effectiveness.

## Features

- \* Ultrahigh-Speed Switching
- \* 4V Drive
- \* Low On-Resistance

Marking : 3314

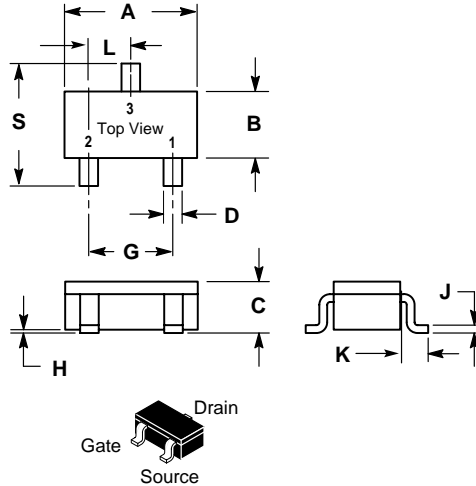

SC-59		
Dim	Min	Max
A	2.70	3.10
B	1.40	1.60
C	1.00	1.30
D	0.35	0.50
G	1.70	2.10
H	0.00	0.10
J	0.10	0.26
K	0.20	0.60
L	0.85	1.15
S	2.40	2.80

All Dimension in mm

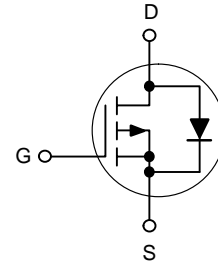

## Absolute Maximum Ratings

Parameter	Symbol	Ratings	Unit
Drain-Source Voltage	V <sub>DS</sub>	-30	V
Gate-Source Voltage	V <sub>GS</sub>	±20	V
Continuous Drain Current <sup>3</sup>	I <sub>D</sub> @T <sub>A</sub> =25 °C	-1.9	A
Continuous Drain Current <sup>3</sup>	I <sub>D</sub> @T <sub>A</sub> =70 °C	-1.5	A
Pulsed Drain Current <sup>1,2</sup>	I <sub>DM</sub>	-10	A
Total Power Dissipation	P <sub>D</sub> @T <sub>A</sub> =25 °C	1.38	W
Linear Derating Factor		0.01	W/°C
Operating Junction and Storage Temperature Range	T <sub>j</sub> , T <sub>stg</sub>	-55~+150	°C

## Thermal Data

Parameter	Symbol	Ratings	Unit
Thermal Resistance Junction-ambient <sup>3</sup>	R <sub>thj-a</sub>	90	°C/W

## Electrical Characteristics( T<sub>j</sub>=25°C Unless otherwise specified)

Parameter	Symbol	Min.	Typ.	Max.	Unit	Test Condition
Drain-Source Breakdown Voltage	BV <sub>DSS</sub>	-30	-	-	V	V <sub>GS</sub> =0V, I <sub>D</sub> =-250uA
Breakdown Voltage Temp. Coefficient	ΔBV <sub>DSS</sub> /ΔT <sub>j</sub>	-	-0.1	-	V/°C	Reference to 25°C, I <sub>D</sub> =-1mA
Gate Threshold Voltage	V <sub>GS(th)</sub>	-1.0	-	-	V	V <sub>DS</sub> =V <sub>GS</sub> , I <sub>D</sub> =-250uA
Gate-Source Leakage Current	I <sub>GSS</sub>	-	-	±100	nA	V <sub>GS</sub> =±20V
Drain-Source Leakage Current (T <sub>j</sub> =25°C)	I <sub>DSS</sub>	-	-	-1	uA	V <sub>DS</sub> =-30V, V <sub>GS</sub> =0
Drain-Source Leakage Current (T <sub>j</sub> =70°C)		-	-	-10	uA	V <sub>DS</sub> =-30V, V <sub>GS</sub> =0
Static Drain-Source On-Resistance <sup>2</sup>	R <sub>DS(ON)</sub>	-	-	240	mΩ	V <sub>GS</sub> =-10V, I <sub>D</sub> =- 1.7A
		-	-	270		V <sub>GS</sub> =-10V, I <sub>D</sub> =- 0.8A
		-	-	460		V <sub>GS</sub> =-4.5V, I <sub>D</sub> =-1.3A
		-	-	500		V <sub>GS</sub> =-4.0V, I <sub>D</sub> =-0.4A
Total Gate Charge <sup>2</sup>	Q <sub>g</sub>	-	6.2	-	nC	I <sub>D</sub> =-1.7A V <sub>DS</sub> =-15V V <sub>GS</sub> =-10V
Gate-Source Charge	Q <sub>gs</sub>	-	1.4	-		
Gate-Drain ("Miller") Charge	Q <sub>gd</sub>	-	0.3	-		
Turn-on Delay Time <sup>2</sup>	T <sub>d(ON)</sub>	-	7.6	-	nS	V <sub>DS</sub> =-15V I <sub>D</sub> =- 1 A V <sub>GS</sub> =-10V R <sub>G</sub> =6 Ω R <sub>D</sub> =15 Ω
Rise Time	T <sub>r</sub>	-	8.2	-		
Turn-off Delay Time	T <sub>d(off)</sub>	-	17.5	-		
Fall Time	T <sub>f</sub>	-	9	-		
Input Capacitance	C <sub>iss</sub>	-	230	-	pF	V <sub>GS</sub> =0V V <sub>DS</sub> =-15V f=1.0MHz
Output Capacitance	C <sub>oss</sub>	-	130.4	-		
Reverse Transfer Capacitance	C <sub>rss</sub>	-	40	-		
Forward Transconductance	G <sub>fs</sub>	-	2	-	S	V <sub>DS</sub> =-10V, I <sub>D</sub> =-1.7A

## Source-Drain Diode

Parameter	Symbol	Min.	Typ.	Max.	Unit	Test Condition
Forward On Voltage <sup>2</sup>	V <sub>SD</sub>	-	-	-1.2	V	I <sub>S</sub> =-1.25A, V <sub>GS</sub> =0V.
Continuous Source Current (Body Diode)	I <sub>S</sub>	-	-	-1	A	V <sub>D</sub> =V <sub>G</sub> =0V, V <sub>S</sub> =-1.2V
Pulsed Source Current (Body Diode) <sup>1</sup>	I <sub>SM</sub>	-	-	-6.4	A	

Notes: 1.Pulse width limited by Max. junction temperature.

2.Pulse width ≤300us, dutycycle ≤2%.

3.Surface mounted on 1 inch<sup>2</sup> copper pad of FR4 board; 270°C/W when mounted on min. copper pad.

**Characteristics Curve**

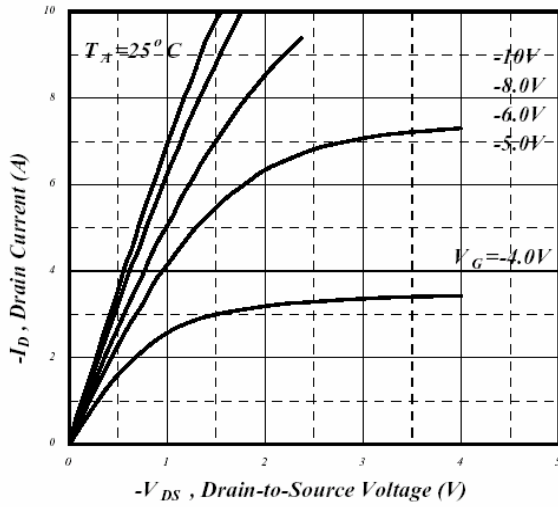

**Fig 1. Typical Output Characteristics**

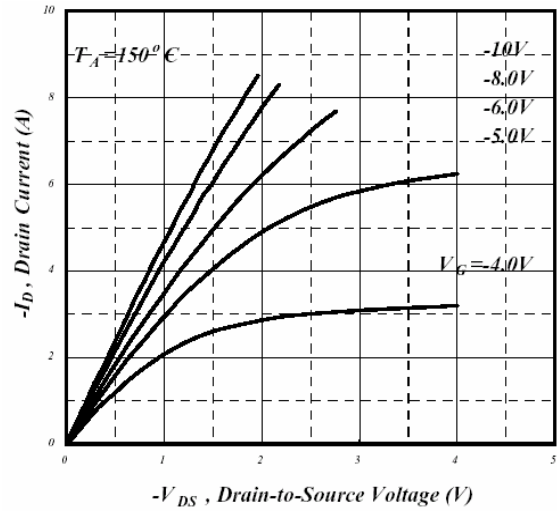

**Fig 2. Typical Output Characteristics**

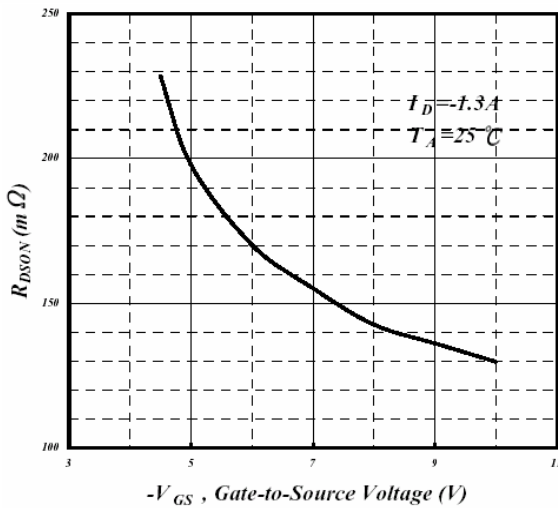

**Fig 3. On-Resistance v.s. Gate Voltage**

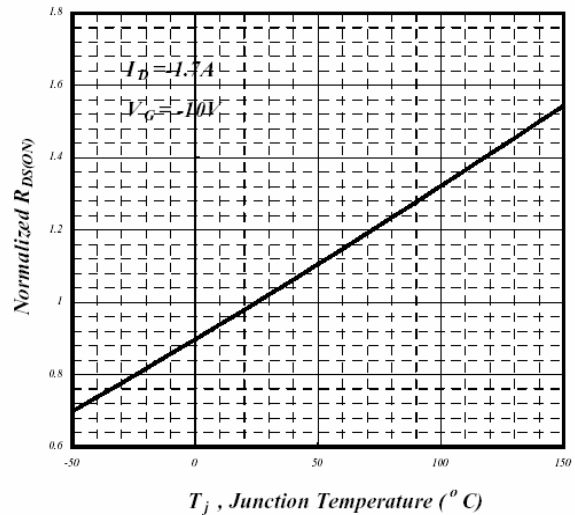

**Fig 4. Normalized On-Resistance**

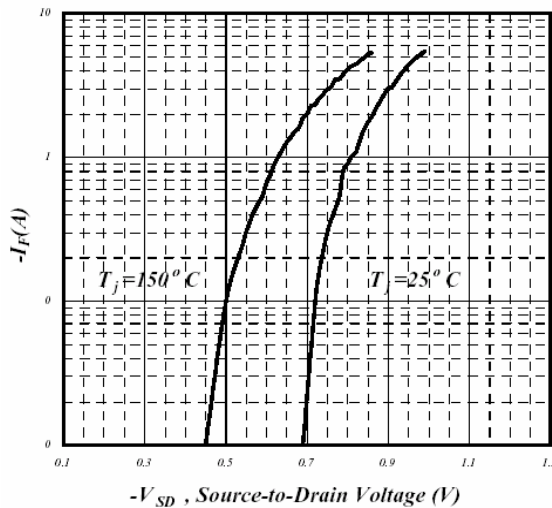

**Fig 5. Forward Characteristic of Reverse Diode**

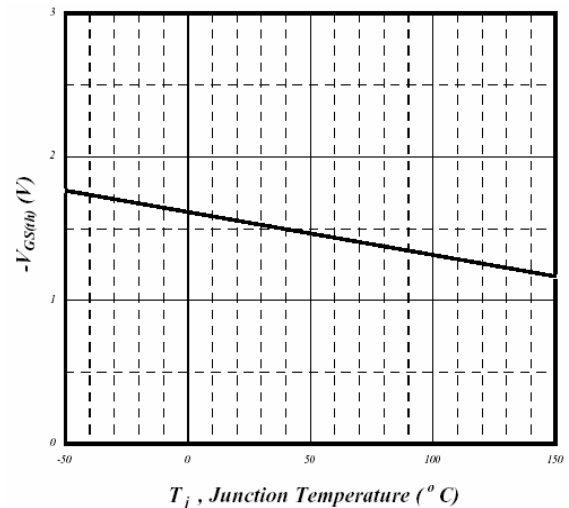

**Fig 6. Gate Threshold Voltage v.s. Junction Temperature**

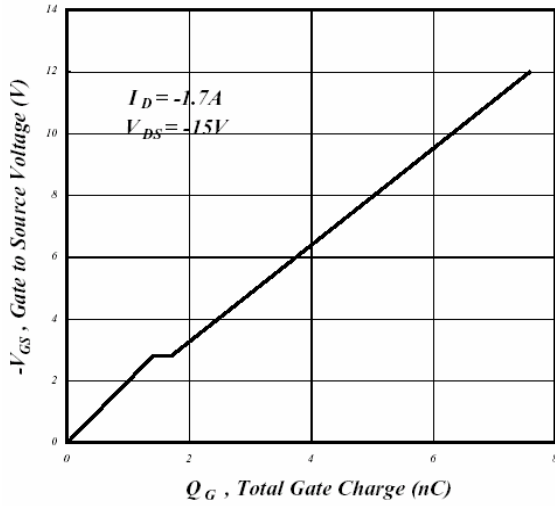

Fig 7. Gate Charge Characteristics

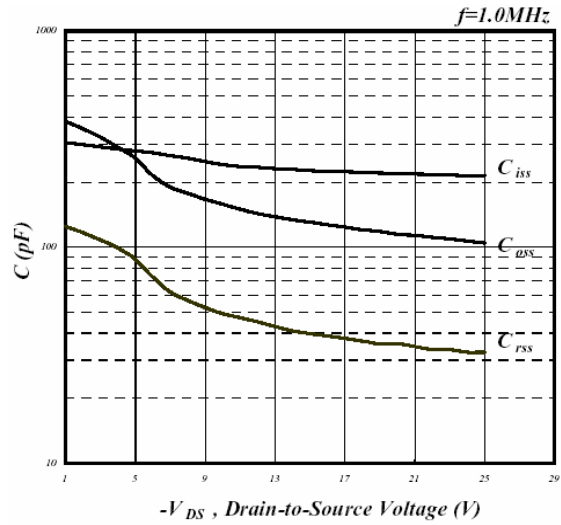

Fig 8. Typical Capacitance Characteristics

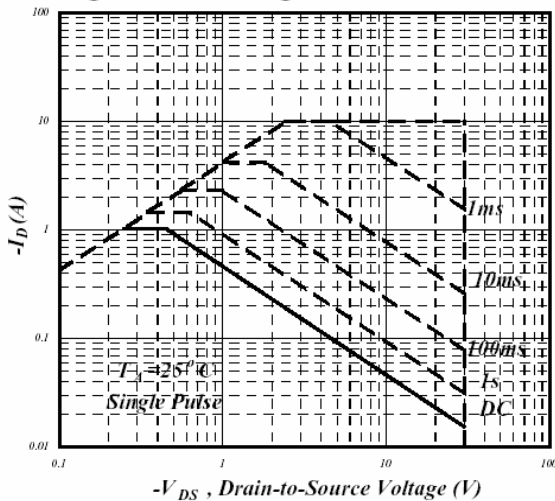

Fig 9. Maximum Safe Operating Area

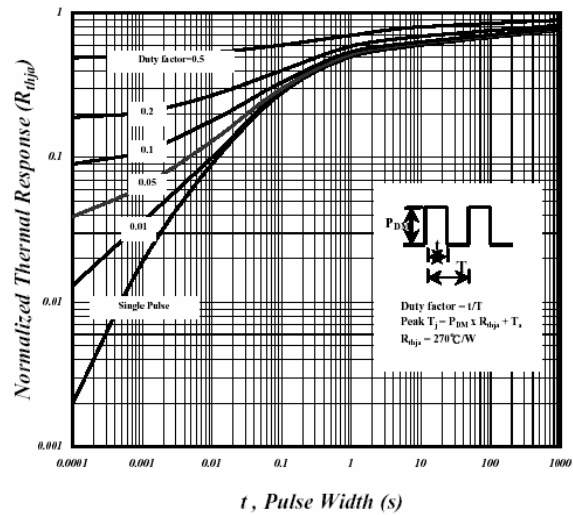

Fig 10. Effective Transient Thermal Impedance

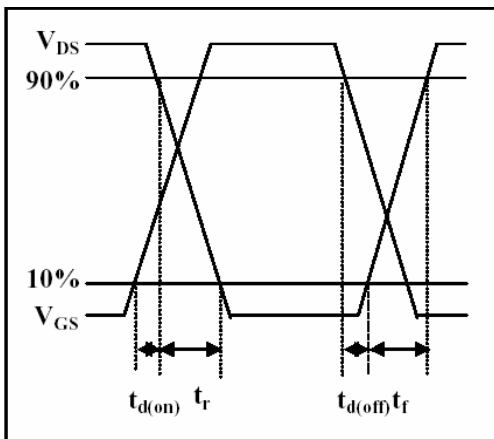

Fig 11. Switching Time Waveform

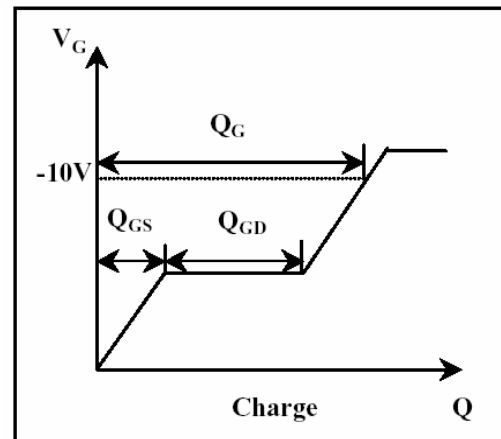

Fig 12. Gate Charge Waveform