

mat'l. code				tolerances unless otherwise specified				CUSTOMER COPY		 Electronics www.fciconnect.com	
ltr	ecn no	dr	date	linear	.X±.3		projection	title			
A	V20042	TWH	1/22/02		.XX±.13			4 CHANNEL			
					.XXX±.051			200 GHz DWDM			
				angles	0° ±2'		 MM	product family		code	
				dr	T.HOUTZ	1/22/02		F.O.		-	
				enr	E.BOYER	1/22/02	size	dwg no	sheet		
				chr	E.BOYER	1/22/02	A4	56907	1 of 3		
				appd	E.BOYER	1/22/02	scale	1:1			
sheet index	revision sheet	A	A	A							
		1	2	3							

cage code
22526

ACAD

PDM: Rev:A

STATUS: Released

Printed: Aug 14, 2008



200GHz 4-CHANNEL DWDM

P/N 56907-T-YXX-LLU-C
S/N XXXXXXXXXXXX

Port 1: xxxx.xnm (ITU CHXX)
Port 2: xxxx.xnm (ITU CHXX)
Port 3: xxxx.xnm (ITU CHXX)
Port 4: xxxx.xnm (ITU CHXX)

LABEL DETAIL

CONNECTOR TYPE REFERENCE TABLE	
CODE C	CONNECTOR DESCRIPTION
0	NO CONNECTORS
1	FC/UPC
2	SC/UPC
3	LC/UPC
4	MU/UPC

CONFIGURATION TABLE	
CODE T	DESCRIPTION
M	MULTIPLEXER
D	DEMULTIPLEXER

FCI PART NUMBER CODE DEFINITION

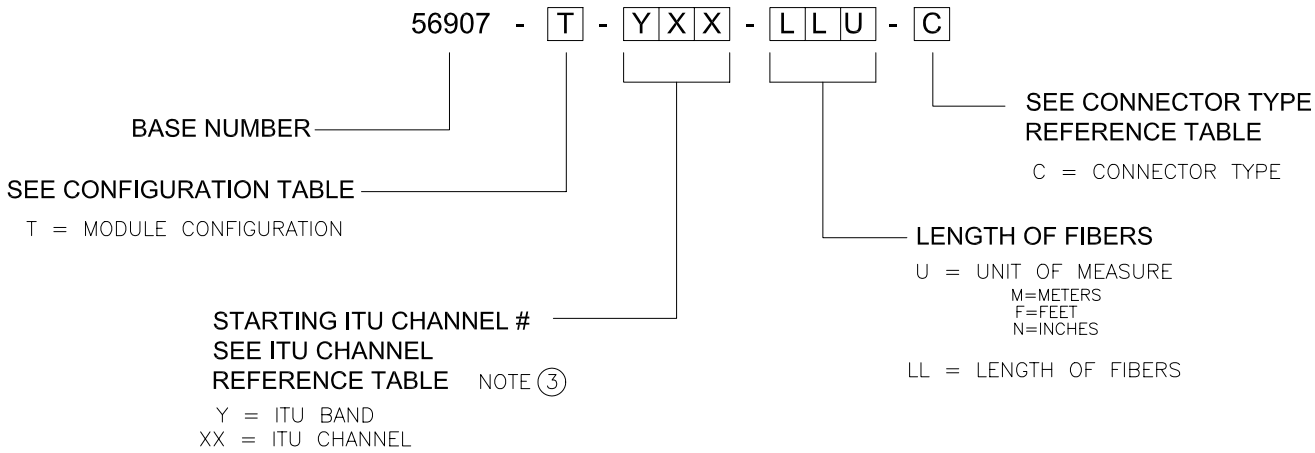

NOTES:

- ① SEE FIGURE FOR FCI P/N DEFINITION.
- ② NOT LIMITED TO CONNECTOR SHOWN, SEE CONNECTOR TYPE REFERENCE TABLE FOR SELECTION.
- ③ THE ITU CHANNEL REFERENCE TABLE INDICATES THE CENTER WAVELENGTH OF THE STARTING CHANNEL, WHICH IS CHOSEN BY THE CUSTOMER. EACH SUBSEQUENT CHANNEL WILL BE SPACED 200GHz (-1.6nm) FROM THE STARTING CHANNEL.

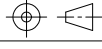
mat'l. code				tolerances unless otherwise specified				CUSTOMER COPY		 Electronics www.fciconnect.com		
ltr	ecn no	dr	date	linear	.X±.3			projection	title			
A					.XX±.13				4 CHANNEL			
					.XXX±.051				200 GHz DWDM			
				angles	0° ±2°			 MM scale 1:1	product family F.O.		code	
				dr	T.HOUTZ	1/22/02	size		dwg no		sheet	
				enr	E.BOYER	1/22/02	A4		56907		2 of	
				chr	E.BOYER	1/22/02						
				appd	E.BOYER	1/22/02						
sheet index	revision sheet											

cage code
22526

Tous droits strictement reserves. Reproduction ou communication a des tiers interdite sous quelque forme que ce soit sans autorisation écrite du propriétaire. Propriete de c FCI. Droits de reproduction FCI

All rights strictly reserved. Reproduction or issue to third parties in any form whatever is not permitted without written authority from the proprietor. Property of FCI. Copyright FCI

ITU CHANNEL REFERENCE TABLE		
YXX	FREQUENCY (THz)	WAVELENGTH (nm)
L48	184.8	1622.25
L49	184.9	1621.38
L50	185.0	1620.50
L51	185.1	1619.62
L52	185.2	1618.75
L53	185.3	1617.88
L54	185.4	1617.00
L55	185.5	1616.13
L56	185.6	1615.26
L57	185.7	1614.39
L58	185.8	1613.52
L59	185.9	1612.65
L60	186.0	1611.79
L61	186.1	1610.92
L62	186.2	1610.06
L63	186.3	1609.19
L64	186.4	1608.33
L65	186.5	1607.47
L66	186.6	1606.60
L67	186.7	1605.74
L68	186.8	1604.88
L69	186.9	1604.03
L70	187.0	1603.17
L71	187.1	1602.31
L72	187.2	1601.46
L73	187.3	1600.60
L74	187.4	1599.75
L75	187.5	1598.89
L76	187.6	1598.04
L77	187.7	1597.19
L78	187.8	1596.34
L79	187.9	1595.49
L80	188.0	1594.64
L81	188.1	1593.79
L82	188.2	1592.95
L83	188.3	1592.10
L84	188.4	1591.26
L85	188.5	1590.41

ITU CHANNEL REFERENCE TABLE		
YXX	FREQUENCY (THz)	WAVELENGTH (nm)
L86	188.6	1589.57
L87	188.7	1588.73
L88	188.8	1587.88
L89	188.9	1587.04
L90	189.0	1586.20
L91	189.1	1585.36
L92	189.2	1584.53
L93	189.3	1583.69
L94	189.4	1582.85
L95	189.5	1582.02
L96	189.6	1581.18
L97	189.7	1580.35
L98	189.8	1579.52
L99	189.9	1578.69
L00	190.0	1577.86
C01	190.1	1577.03
C02	190.2	1576.20
C03	190.3	1575.37
C04	190.4	1574.54
C05	190.5	1573.71
C06	190.6	1572.89
C07	190.7	1572.06
C08	190.8	1571.24
C09	190.9	1570.42
C10	191.0	1569.59
C11	191.1	1568.77
C12	191.2	1567.95
C13	191.3	1567.13
C14	191.4	1566.31
C15	191.5	1565.50
C16	191.6	1564.68
C17	191.7	1563.86
C18	191.8	1563.05
C19	191.9	1562.23
C20	192.0	1561.42
C21	192.1	1560.61
C22	192.2	1559.79
C23	192.3	1558.98

ITU CHANNEL REFERENCE TABLE		
YXX	FREQUENCY (THz)	WAVELENGTH (nm)
C24	192.4	1558.17
C25	192.5	1557.36
C26	192.6	1556.55
C27	192.7	1555.75
C28	192.8	1554.94
C29	192.9	1554.13
C30	193.0	1553.33
C31	193.1	1552.52
C32	193.2	1551.72
C33	193.3	1550.92
C34	193.4	1550.12
C35	193.5	1549.32
C36	193.6	1548.51
C37	193.7	1547.72
C38	193.8	1546.92
C39	193.9	1546.12
C40	194.0	1545.32
C41	194.1	1544.53
C42	194.2	1543.73
C43	194.3	1542.94
C44	194.4	1542.14
C45	194.5	1541.35
C46	194.6	1540.56
C47	194.7	1539.77
C48	194.8	1538.98
C49	194.9	1538.19
C50	195.0	1537.40
C51	195.1	1536.61
C52	195.2	1535.82
C53	195.3	1535.04
C54	195.4	1534.25
C55	195.5	1533.47
C56	195.6	1532.68
C57	195.7	1531.90
C58	195.8	1531.12
C59	195.9	1530.33
C60	196.0	1529.55
C61	196.1	1528.77

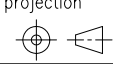
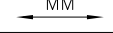
mat'l. code				tolerances unless otherwise specified			CUSTOMER COPY		 www.fciconnect.com		
ltr	ecn no	dr	date	linear	.X±.3		projection	 title 4 CHANNEL 200 GHz DWDM			
A					.XX±.13						
				angles	.XXX±.051		 MM	product family		code	
					0° ±2°			F.O.		-	
				dr	T.HOUTZ	1/22/02	scale	size		sheet	
				enr	E.BOYER	1/22/02		dwg no			3 of
				chr	E.BOYER	1/22/02		A4			
				appd	E.BOYER	1/22/02		56907			
sheet index	revision sheet										

cage code
22526

ACAD

PDM: Rev:A

STATUS:Released

Printed: Aug 14, 2008