

# BYT54M

## SINTERED GLASS JUNCTION FAST AVALANCHE RECTIFIER

VOLTAGE: 1000V

CURRENT: 1.25A

www.DataSheet4U.com



### FEATURE

Glass passivated  
Hermetically sealed package  
Low reverse current  
Soft recovery characteristics

### MECHANICAL DATA

Case: SOD-57 sintered glass case  
Terminal: Plated axial leads solderable per MIL-STD 202E, method 208C  
Polarity: color band denotes cathode end  
Mounting position: any

### SOD-57

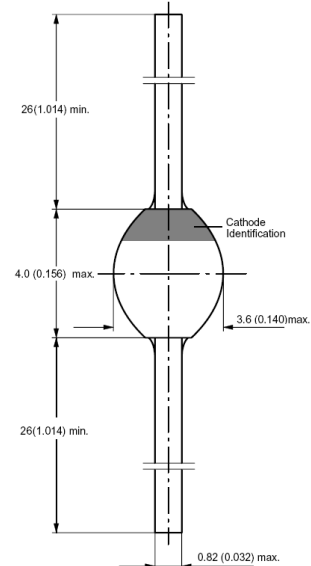

Dimensions in inches and (millimeters)

## MAXIMUM RATINGS AND ELECTRICAL CHARACTERISTICS

(single-phase, half-wave, 60HZ, resistive or inductive load rating at 25°C, unless otherwise stated)

	SYMBOL	BYT54M	units
Maximum Recurrent Peak Reverse Voltage	$V_{RRM}$	1000	V
Maximum RMS Voltage	$V_{RMS}$	700	V
Maximum DC blocking Voltage	$V_{DC}$	1000	V
Maximum Average Forward Rectified Current 3/8" lead length at $l = 10\text{mm}$	$I_{FAV}$	1.25	A
Peak Forward Surge Current at $t_p = 10\text{ms}$ , half sinewave	$I_{FSM}$	30	A
Maximum Forward Voltage at rated Forward Current at $I_F = 1.0\text{A}$	$V_F$	1.5	V
Non-repetitive peak reverse avalanche energy at $I_{BR(R)} = 0.4\text{A}$	$E_{RSM}$	10	mJ
Maximum DC Reverse Current at rated DC blocking voltage	$I_R$	5.0 150.0	$\mu\text{A}$ $\mu\text{A}$
Maximum Reverse Recovery Time (Note 1)	$T_{rr}$	100	nS
Typical Thermal Resistance (Note 2)	$R_{th(ja)}$	100	$^{\circ}\text{C}/\text{W}$
Storage and Operating Junction Temperature	$T_{stg}, T_j$	-65 to +175	$^{\circ}\text{C}$

Note:

- Reverse Recovery Condition  $I_f = 0.5\text{A}$ ,  $I_r = 1.0\text{A}$ ,  $I_{rr} = 0.25\text{A}$
- on PC board with spacing 25 mm

RATINGS AND CHARACTERISTIC CURVES BYT54M

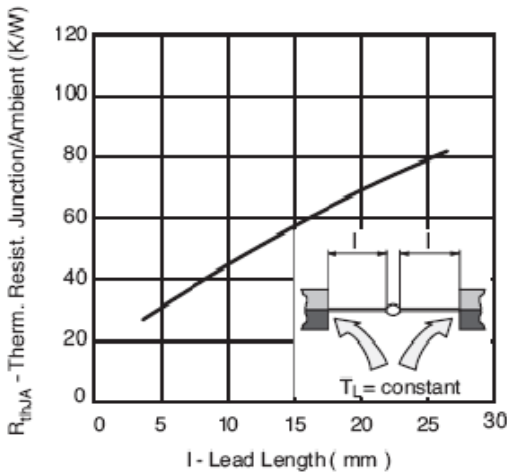

Figure 1. Max. Thermal Resistance vs. Lead Length

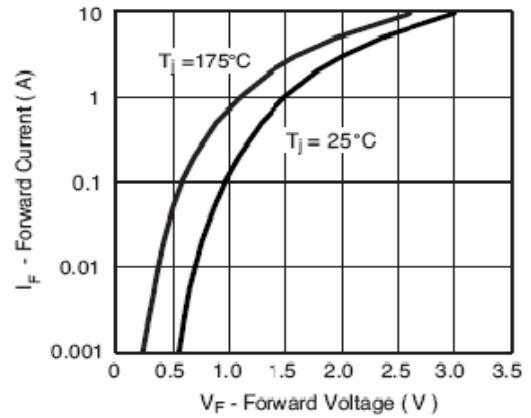

Figure 2. Forward Current vs. Forward Voltage

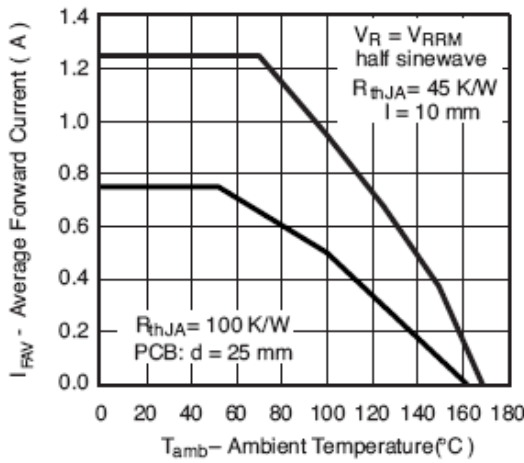

Figure 3. Max. Average Forward Current vs. Ambient Temperature

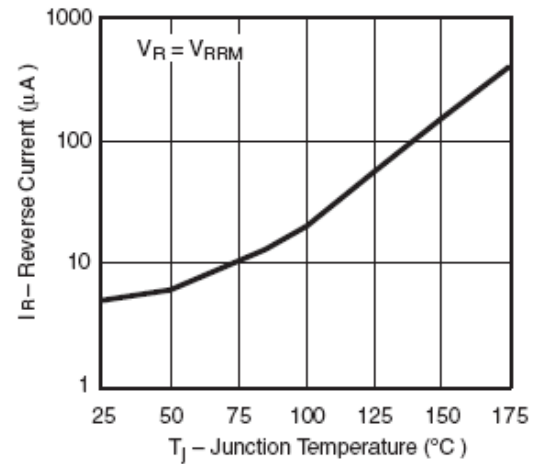

Figure 4. Reverse Current vs. Junction Temperature

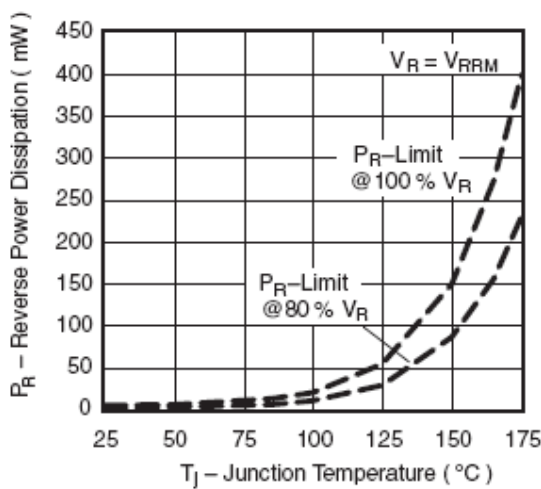

Figure 5. Max. Reverse Power Dissipation vs. Junction Temperature

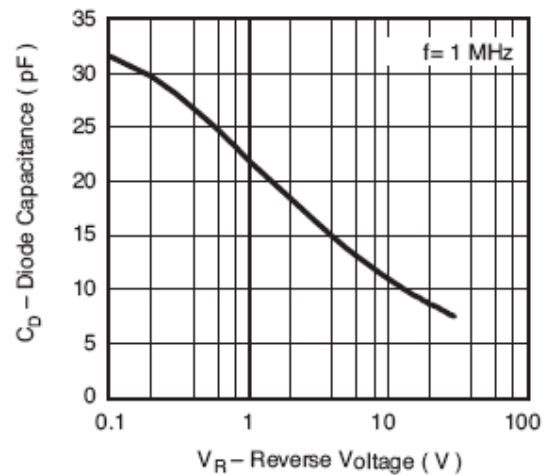

Figure 6. Diode Capacitance vs. Reverse Voltage