

Optocoupler, Low Input Current, Phototransistor Output



17918_10



FEATURES

- Temperature range - 55 °C to + 110 °C
- Rated impulse voltage (transient overvoltage) $V_{IOTM} = 6 \text{ kV}_{\text{peak}}$
- Isolation test voltage (partial discharge test voltage) $V_{pd} = 1.6 \text{ kV}$
- Rated isolation voltage (RMS includes DC) $V_{IOWM} = 600 \text{ V}_{\text{RMS}}$
- Rated recurring peak voltage (repetitive) $V_{IORM} = 850 \text{ V}_{\text{peak}}$
- Thickness through insulation $\geq 0.4 \text{ mm}$
- Material categorization: For definitions of compliance please see www.vishay.com/doc?99912



RoHS COMPLIANT

APPLICATIONS

Circuits for safe protective separation against electrical shock according to safety class II (reinforced isolation):

- for appl. class I - IV at mains voltage $\leq 300 \text{ V}$
- for appl. class I - IV at mains voltage $\leq 600 \text{ V}$ according to table 1 of IEC 60664-1, suitable for:
 - Switch-mode power supplies
 - Line receiver
 - Computer peripheral interface
 - Microprocessor system interface

DESCRIPTION

The VO610A consists of a phototransistor optically coupled to a gallium arsenide infrared-emitting diode in a 4 pin plastic dual inline package.

AGENCY APPROVALS

(All parts are certified under base model VO610A)

- BSI: EN 60065:2002, EN 60950:2000
- DIN EN 60747-5-5, available with option 1
- FIMKO EN 60065, EN 60335-1, EN 60950-1
- UL file no. E52744
- cUL tested to CSA 22.2 bulletin 5A
- CQC GB4943.1-2011, GB8898-2011

ORDERING INFORMATION

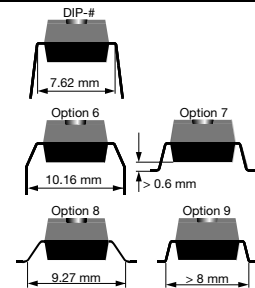
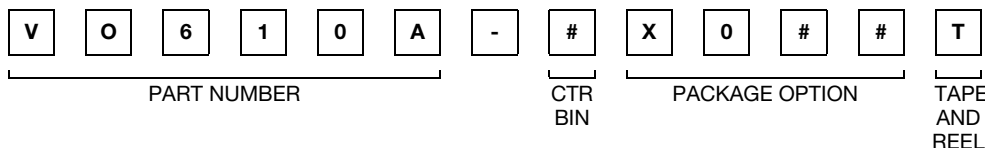

AGENCY CERTIFIED/PACKAGE	CTR (%)			
	40 to 80	63 to 125	100 to 200	160 to 320
BSI, FIMKO, UL, cUL				
DIP-4	VO610A-1	VO610A-2	VO610A-3	-
SMD-4, option 7	-	-	VO610A-3X007T	-
SMD-4, option 8	-	-	VO610A-3X008T	VO610A-4X008T
SMD-4, option 9	-	-	VO610A-3X009T	-
VDE, BSI, FIMKO, UL, cUL				
DIP-4	-	-	VO610A-3X001	-
DIP-4, 400 mil, option 6	-	-	VO610A-3X016	-
SMD-4, option 7	-	-	-	VO610A-4X017T
SMD-4, option 8	-	-	VO610A-3X018T	-
SMD-4, option 9	VO610A-1X019T	-	VO610A-3X019T	VO610A-4X019T

Note

- Additional options may be possible, please contact sales office



ABSOLUTE MAXIMUM RATINGS ($T_{amb} = 25\text{ }^{\circ}\text{C}$, unless otherwise specified)				
PARAMETER	TEST CONDITION	SYMBOL	VALUE	UNIT
INPUT				
Reverse voltage		V_R	6	V
Forward current		I_F	60	mA
Forward surge current	$t_p \leq 10\text{ }\mu\text{s}$	I_{FSM}	1.5	A
LED power dissipation	at $25\text{ }^{\circ}\text{C}$	P_{diss}	100	mW
OUTPUT				
Collector emitter voltage		V_{CEO}	70	V
Emitter collector voltage		V_{ECO}	7	V
Collector current		I_C	50	mA
Collector peak current	$t_p/T = 0.5$, $t_p \leq 10\text{ ms}$	I_{CM}	100	mA
Output power dissipation	at $25\text{ }^{\circ}\text{C}$	P_{diss}	150	mW
COUPLER				
Isolation test voltage (RMS)	$t = 1\text{ min}$	V_{ISO}	5000	V_{RMS}
Operating ambient temperature range		T_{amb}	- 55 to + 110	$^{\circ}\text{C}$
Storage temperature range		T_{stg}	- 55 to + 125	$^{\circ}\text{C}$
Soldering temperature ⁽¹⁾	2 mm from case, $\leq 10\text{ s}$	T_{slid}	260	$^{\circ}\text{C}$

Notes

- Stresses in excess of the absolute maximum ratings can cause permanent damage to the device. Functional operation of the device is not implied at these or any other conditions in excess of those given in the operational sections of this document. Exposure to absolute maximum ratings for extended periods of the time can adversely affect reliability.

⁽¹⁾ Refer to reflow profile for soldering conditions for surface mounted parts (SMD), and wave profile for soldering conditions for through hole parts (DIP), please go to "Assembly Instructions" (www.vishay.com/doc?80054).

ELECTRICAL CHARACTERISTICS ($T_{amb} = 25\text{ }^{\circ}\text{C}$, unless otherwise specified)						
PARAMETER	TEST CONDITION	SYMBOL	MIN.	TYP.	MAX.	UNIT
INPUT						
Forward voltage	$I_F = 50\text{ mA}$	V_F		1.25	1.6	V
Reverse current	$V_R = 6\text{ V}$	I_R			100	μA
Junction capacitance	$V_R = 0$, $f = 1\text{ MHz}$	C_j		50		pF
OUTPUT						
Collector emitter voltage	$I_C = 1\text{ mA}$	V_{CEO}	70			V
Emitter collector voltage	$I_E = 100\text{ }\mu\text{A}$	V_{ECO}	7			V
Collector emitter cut-off current	$V_{CE} = 20\text{ V}$, $I_F = 0\text{ A}$	I_{CEO}		10	100	nA
COUPLER						
Collector emitter saturation voltage	$I_F = 10\text{ mA}$, $I_C = 1\text{ mA}$	V_{CEsat}			0.3	V
Cut-off frequency	$V_{CE} = 5\text{ V}$, $I_F = 10\text{ mA}$, $R_L = 100\text{ }\Omega$	f_c		110		kHz
Coupling capacitance	$f = 1\text{ MHz}$	C_k		0.6		pF

Note

- Minimum and maximum values are testing requirements. Typical values are characteristics of the device and are the result of engineering evaluation. Typical values are for information only and are not part of the testing requirements.

SWITCHING CHARACTERISTICS ($T_{amb} = 25\text{ }^{\circ}\text{C}$, unless otherwise specified)						
PARAMETER	TEST CONDITION	SYMBOL	MIN.	TYP.	MAX.	UNIT
Delay time	$V_S = 5\text{ V}$, $I_C = 2\text{ mA}$, $R_L = 100\text{ }\Omega$, (see figure 3)	t_d		3		μs
Rise time	$V_S = 5\text{ V}$, $I_C = 2\text{ mA}$, $R_L = 100\text{ }\Omega$, (see figure 3)	t_r		3		μs
Fall time	$V_S = 5\text{ V}$, $I_C = 2\text{ mA}$, $R_L = 100\text{ }\Omega$, (see figure 3)	t_f		4.7		μs
Storage time	$V_S = 5\text{ V}$, $I_C = 2\text{ mA}$, $R_L = 100\text{ }\Omega$, (see figure 3)	t_s		0.3		μs
Turn-on time	$V_S = 5\text{ V}$, $I_C = 2\text{ mA}$, $R_L = 100\text{ }\Omega$, (see figure 3)	t_{on}		6		μs
Turn-off time	$V_S = 5\text{ V}$, $I_C = 2\text{ mA}$, $R_L = 100\text{ }\Omega$, (see figure 3)	t_{off}		5		μs
Turn-on time	$V_S = 5\text{ V}$, $I_F = 10\text{ mA}$, $R_L = 1\text{ k}\Omega$, (see figure 4)	t_{on}		9		μs
Turn-off time	$V_S = 5\text{ V}$, $I_F = 10\text{ mA}$, $R_L = 1\text{ k}\Omega$, (see figure 4)	t_{off}		10		μs



95 10804

Fig. 3 - Test Circuit, Non-Saturated Operation



Fig. 5 - Switching Times

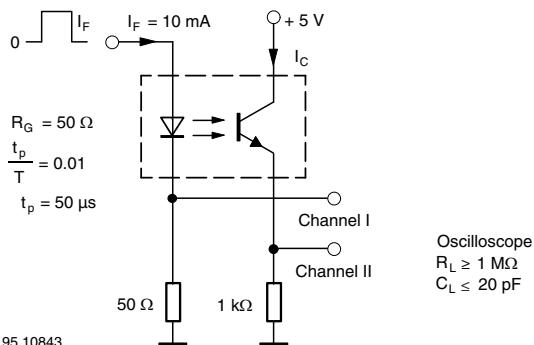

95 10843

Fig. 4 - Test Circuit, Saturated Operation

PACKAGE DIMENSIONS in millimeters



Option 6



Option 7



Option 8

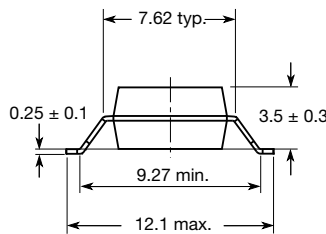

Option 9



20802-38

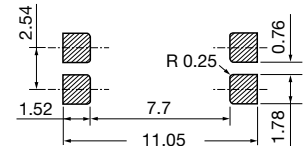

PACKAGE MARKING (Example of VO617A-3X018T)

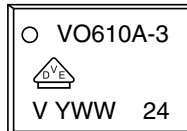

Note

- Only options 1, 7, and 8 are reflected in the package marking.
- The VDE logo is only printed on option 1 parts.
- Tape and reel suffix (T) is not part of the package marking.

PACKING INFORMATION

DEVICE PER TUBE			
TYPE	UNITS/TUBE	TUBES/BOX	UNITS/BOX
DIP-4, standard and option 6	100	40	4000



Fig. 6 - Tape and Reel Shipping Medium



Fig. 7 - Tape and Reel Packing for Option 7 and Option 9 (1000 units per reel)

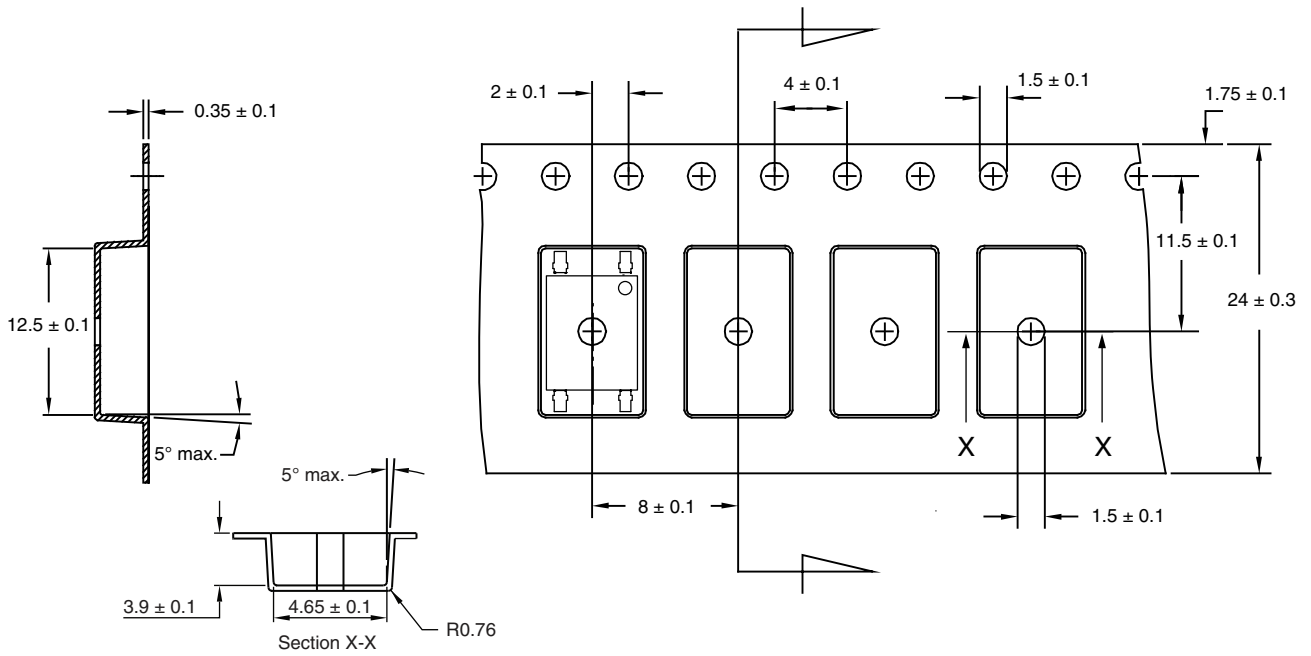

Fig. 8 - Tape and Reel Packing for Option 8
(2000 units per reel)



Disclaimer

ALL PRODUCT, PRODUCT SPECIFICATIONS AND DATA ARE SUBJECT TO CHANGE WITHOUT NOTICE TO IMPROVE RELIABILITY, FUNCTION OR DESIGN OR OTHERWISE.

Vishay Intertechnology, Inc., its affiliates, agents, and employees, and all persons acting on its or their behalf (collectively, "Vishay"), disclaim any and all liability for any errors, inaccuracies or incompleteness contained in any datasheet or in any other disclosure relating to any product.

Vishay makes no warranty, representation or guarantee regarding the suitability of the products for any particular purpose or the continuing production of any product. To the maximum extent permitted by applicable law, Vishay disclaims (i) any and all liability arising out of the application or use of any product, (ii) any and all liability, including without limitation special, consequential or incidental damages, and (iii) any and all implied warranties, including warranties of fitness for particular purpose, non-infringement and merchantability.

Statements regarding the suitability of products for certain types of applications are based on Vishay's knowledge of typical requirements that are often placed on Vishay products in generic applications. Such statements are not binding statements about the suitability of products for a particular application. It is the customer's responsibility to validate that a particular product with the properties described in the product specification is suitable for use in a particular application. Parameters provided in datasheets and/or specifications may vary in different applications and performance may vary over time. All operating parameters, including typical parameters, must be validated for each customer application by the customer's technical experts. Product specifications do not expand or otherwise modify Vishay's terms and conditions of purchase, including but not limited to the warranty expressed therein.

Except as expressly indicated in writing, Vishay products are not designed for use in medical, life-saving, or life-sustaining applications or for any other application in which the failure of the Vishay product could result in personal injury or death. Customers using or selling Vishay products not expressly indicated for use in such applications do so at their own risk. Please contact authorized Vishay personnel to obtain written terms and conditions regarding products designed for such applications.

No license, express or implied, by estoppel or otherwise, to any intellectual property rights is granted by this document or by any conduct of Vishay. Product names and markings noted herein may be trademarks of their respective owners.

Material Category Policy

Vishay Intertechnology, Inc. hereby certifies that all its products that are identified as RoHS-Compliant fulfill the definitions and restrictions defined under Directive 2011/65/EU of The European Parliament and of the Council of June 8, 2011 on the restriction of the use of certain hazardous substances in electrical and electronic equipment (EEE) - recast, unless otherwise specified as non-compliant.

Please note that some Vishay documentation may still make reference to RoHS Directive 2002/95/EC. We confirm that all the products identified as being compliant to Directive 2002/95/EC conform to Directive 2011/65/EU.

Vishay Intertechnology, Inc. hereby certifies that all its products that are identified as Halogen-Free follow Halogen-Free requirements as per JEDEC JS709A standards. Please note that some Vishay documentation may still make reference to the IEC 61249-2-21 definition. We confirm that all the products identified as being compliant to IEC 61249-2-21 conform to JEDEC JS709A standards.