

# General Purpose Transistors

## NPN Silicon

- We declare that the material of product compliance with RoHS requirements.

**LBC817-16LT1G**  
**LBC817-25LT1G**  
**LBC817-40LT1G**

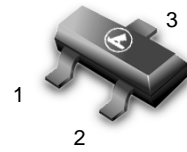

**SOT-23**

### MAXIMUM RATINGS

Rating	Symbol	Value	Unit
Collector–Emitter Voltage	$V_{CEO}$	45	V
Collector–Base Voltage	$V_{CBO}$	50	V
Emitter–Base Voltage	$V_{EBO}$	5.0	V
Collector Current — Continuous	$I_C$	500	mAdc

### THERMAL CHARACTERISTICS

Characteristic	Symbol	Max	Unit
Total Device Dissipation FR– 5 Board, (1) $T_A = 25^\circ\text{C}$	$P_D$	225	mW
Derate above $25^\circ\text{C}$		1.8	mW/ $^\circ\text{C}$
Thermal Resistance, Junction to Ambient	$R_{\theta JA}$	556	$^\circ\text{C}/\text{W}$
Total Device Dissipation Alumina Substrate, (2) $T_A = 25^\circ\text{C}$	$P_D$	300	mW
Derate above $25^\circ\text{C}$		2.4	mW/ $^\circ\text{C}$
Thermal Resistance, Junction to Ambient	$R_{\theta JA}$	417	$^\circ\text{C}/\text{W}$
Junction and Storage Temperature	$T_J, T_{stg}$	-55 to +150	$^\circ\text{C}$

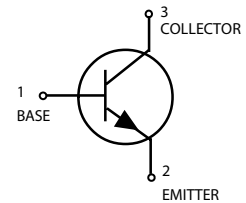

### DEVICE MARKING

LBC817-16LT1G = 6A; LBC817-25LT1G = 6B; LBC817-40LT1G = 6C

### ELECTRICAL CHARACTERISTICS ( $T_A = 25^\circ\text{C}$ unless otherwise noted.)

Characteristic	Symbol	Min	Typ	Max	Unit
----------------	--------	-----	-----	-----	------

### OFF CHARACTERISTICS

Collector–Emitter Breakdown Voltage ( $I_C = 10\text{ mA}$ )	$V_{(BR)CEO}$	45	—	—	V
Collector–Emitter Breakdown Voltage ( $V_{EB} = 0, I_C = 10\ \mu\text{A}$ )	$V_{(BR)CES}$	50	—	—	V
Emitter–Base Breakdown Voltage ( $I_E = 1.0\ \mu\text{A}$ )	$V_{(BR)EBO}$	5.0	—	—	V
Collector Cutoff Current ( $V_{CB} = 20\text{ V}$ )	$I_{CBO}$	—	—	100	nA
( $V_{CB} = 20\text{ V}, T_A = 150^\circ\text{C}$ )		—	—	5.0	$\mu\text{A}$

1. FR-5 = 1.0 x 0.75 x 0.062 in.

2. Alumina = 0.4 x 0.3 x 0.024 in. 99.5% alumina.

LBC817-16LT1G LBC817-25LT1G LBC817-40LT1G

**ELECTRICAL CHARACTERISTICS** ( $T_A = 25^\circ\text{C}$  unless otherwise noted) (Continued)

Characteristic	Symbol	Min	Typ	Max	Unit
----------------	--------	-----	-----	-----	------

**ON CHARACTERISTICS**

DC Current Gain ( $I_C = 100\text{ mA}$ , $V_{CE} = 1.0\text{ V}$ )	$h_{FE}$	100	—	250	
LBC817-16		160	—	400	
LBC817-25		250	—	600	
LBC817-40		40	—	—	
( $I_C = 500\text{ mA}$ , $V_{CE} = 1.0\text{ V}$ )					
Collector-Emitter Saturation Voltage ( $I_C = 500\text{ mA}$ , $I_B = 50\text{ mA}$ )	$V_{CE(sat)}$	—	—	0.7	V
Base-Emitter On Voltage ( $I_C = 500\text{ mA}$ , $V_{CE} = 1.0\text{ V}$ )	$V_{BE(on)}$	—	—	1.2	V

**SMALL-SIGNAL CHARACTERISTICS**

Current-Gain — Bandwidth Product ( $I_C = 10\text{ mA}$ , $V_{CE} = 5.0\text{ V}_{dc}$ , $f = 100\text{ MHz}$ )	$f_T$	100	—	—	MHz
Output Capacitance ( $V_{CB} = 10\text{ V}$ , $f = 1.0\text{ MHz}$ )	$C_{obo}$	—	10	—	pF

**ORDERING INFORMATION**

Device	Marking	Shipping
LBC817-16LT1G	6A	3000/Tape&Reel
LBC817-16LT3G	6A	10000/Tape&Reel
LBC817-25LT1G	6B	3000/Tape&Reel
LBC817-25LT3G	6B	10000/Tape&Reel
LBC817-40LT1G	6C	3000/Tape&Reel
LBC817-40LT3G	6C	10000/Tape&Reel

LBC817-16LT1G LBC817-25LT1G LBC817-40LT1G

TYPICAL CHARACTERISTICS – LBC817-16LT1G

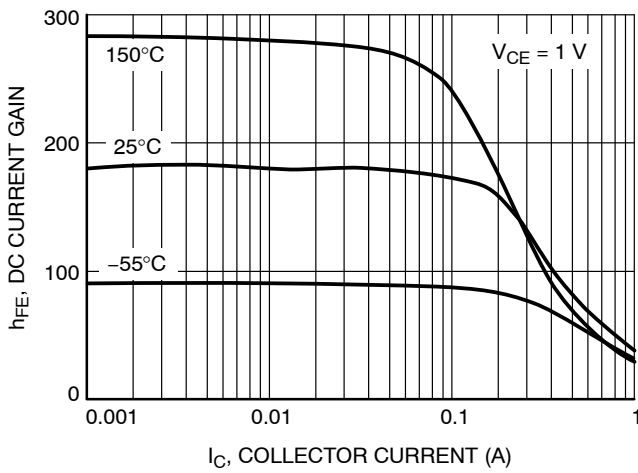

Figure 1. DC Current Gain vs. Collector Current

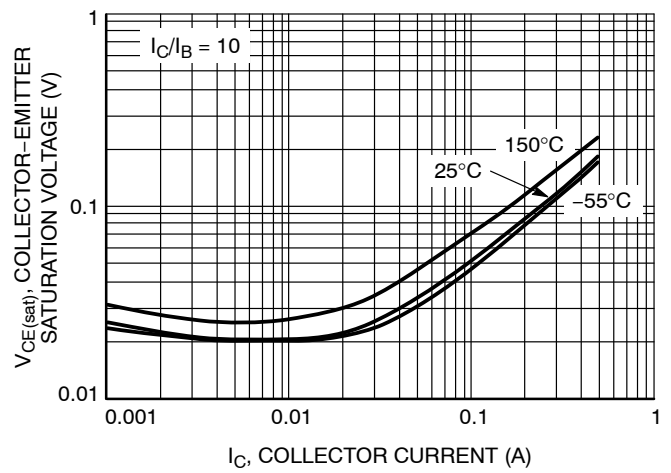

Figure 2. Collector Emitter Saturation Voltage vs. Collector Current

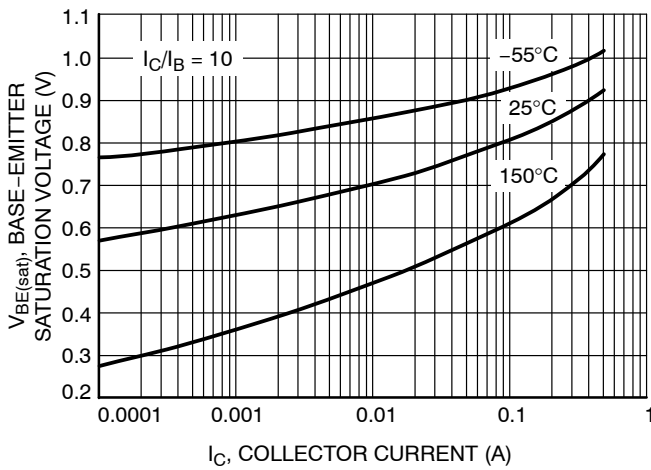

Figure 3. Base Emitter Saturation Voltage vs. Collector Current

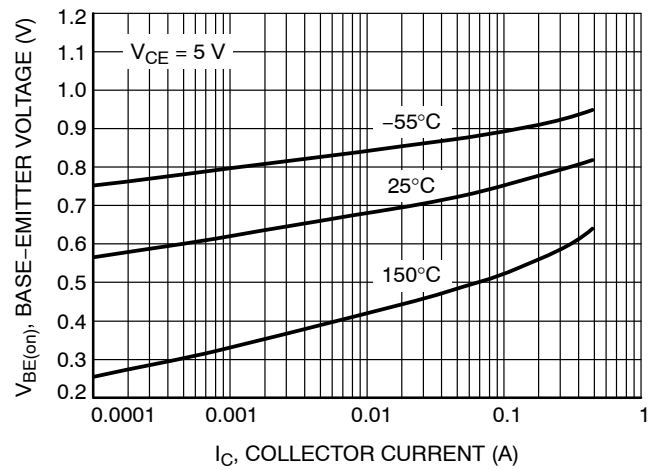

Figure 4. Base Emitter Voltage vs. Collector Current

LBC817-16LT1G LBC817-25LT1G LBC817-40LT1G

TYPICAL CHARACTERISTICS - LBC817-16LT1G

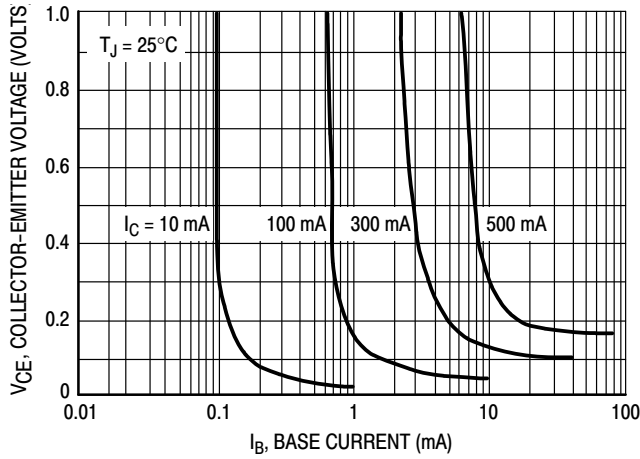

Figure 5. Saturation Region

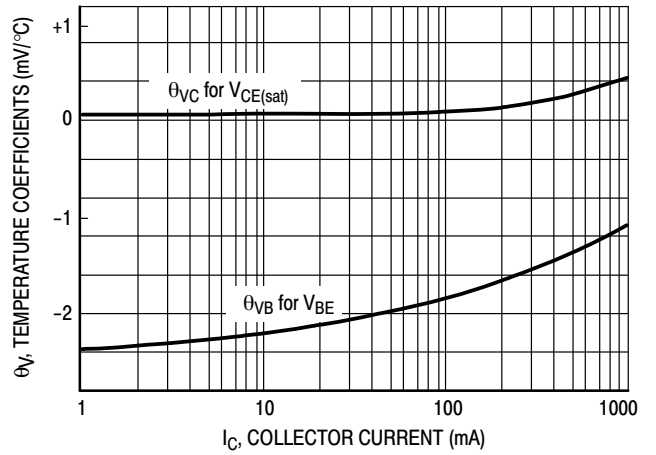

Figure 6. Temperature Coefficients

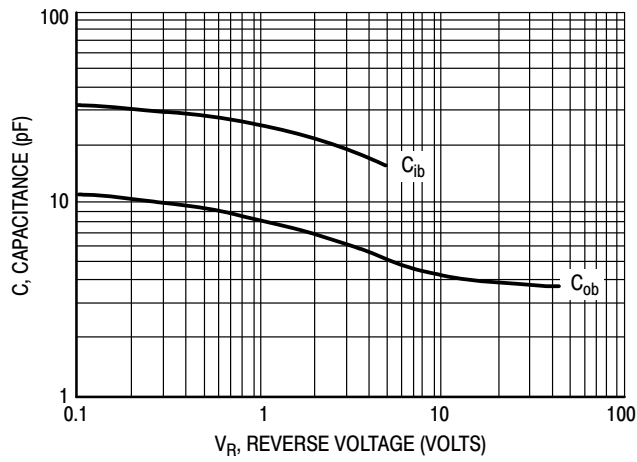
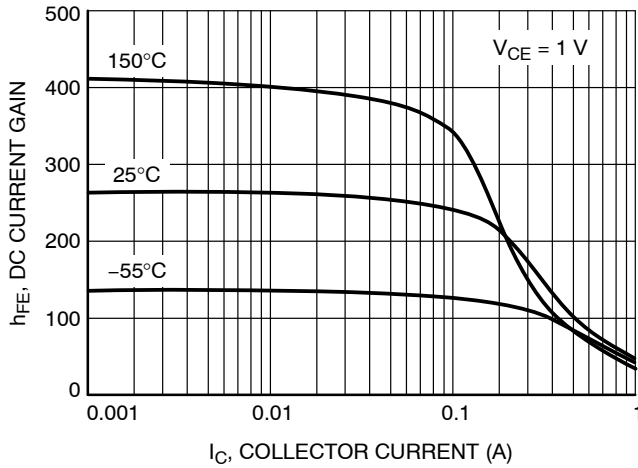
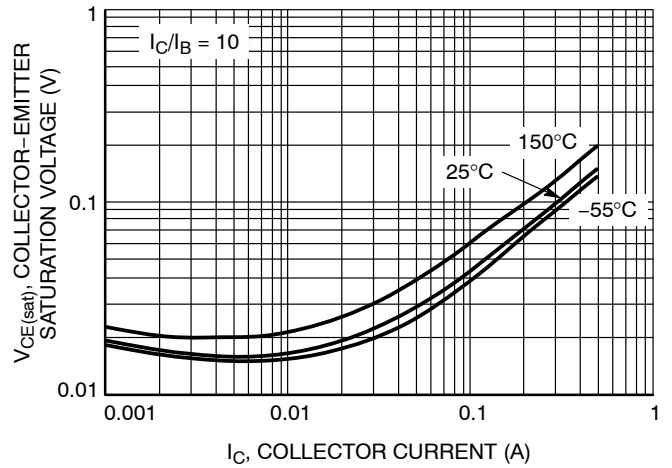
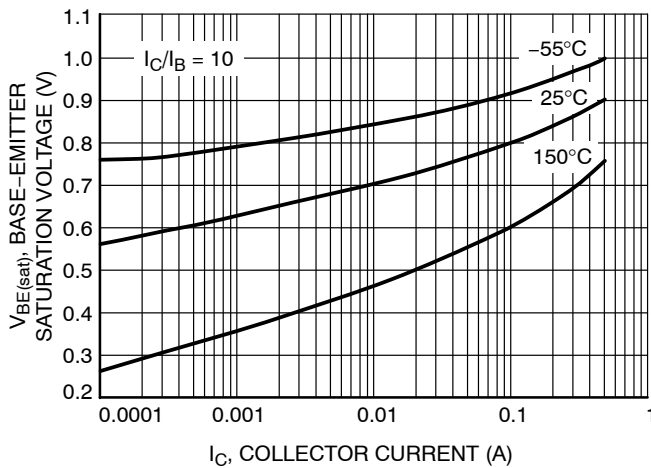
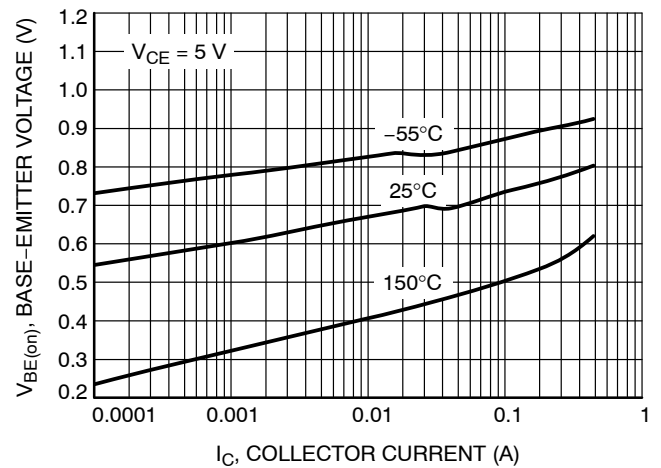
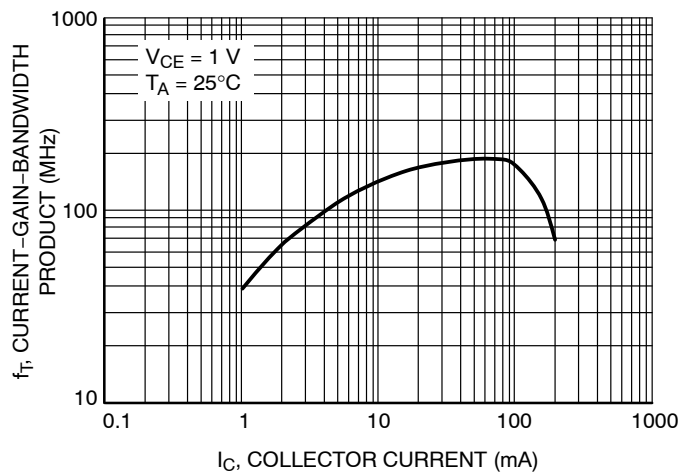

Figure 7. Capacitances

LBC817-16LT1G LBC817-25LT1G LBC817-40LT1G

**TYPICAL CHARACTERISTICS – LBC817-25LT1G**

**Figure 8. DC Current Gain vs. Collector Current**

**Figure 9. Collector Emitter Saturation Voltage vs. Collector Current**

**Figure 10. Base Emitter Saturation Voltage vs. Collector Current**

**Figure 11. Base Emitter Voltage vs. Collector Current**

**Figure 12. Current Gain Bandwidth Product vs. Collector Current**

LBC817-16LT1G LBC817-25LT1G LBC817-40LT1G

TYPICAL CHARACTERISTICS - LBC817-25LT1G

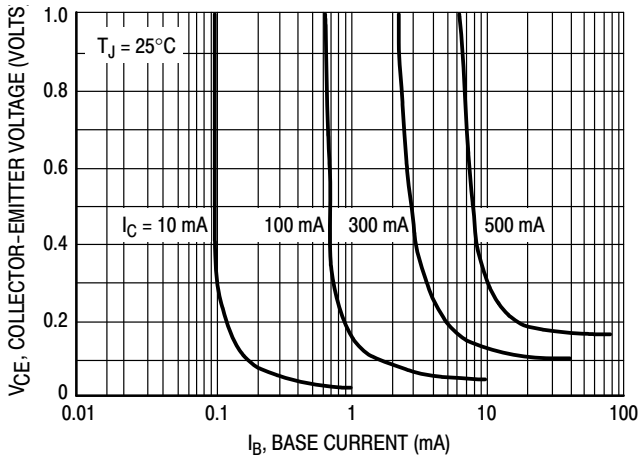

Figure 13. Saturation Region

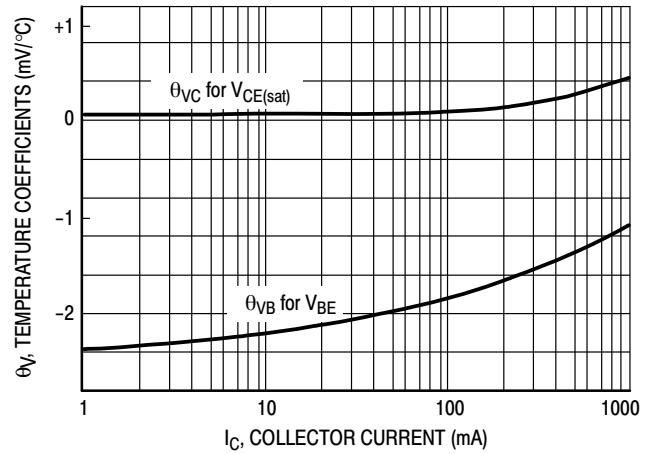

Figure 14. Temperature Coefficients

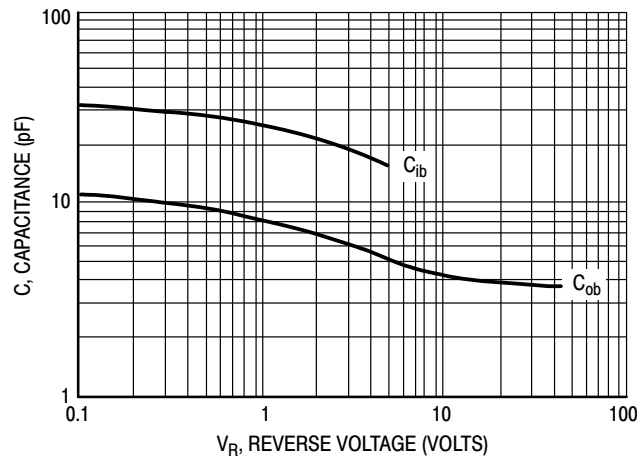

Figure 15. Capacitances

LBC817-16LT1G LBC817-25LT1G LBC817-40LT1G

TYPICAL CHARACTERISTICS – LBC817-40LT1G

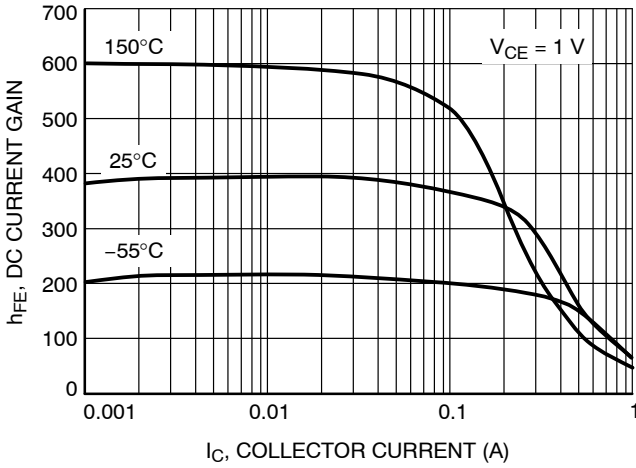

Figure 16. DC Current Gain vs. Collector Current

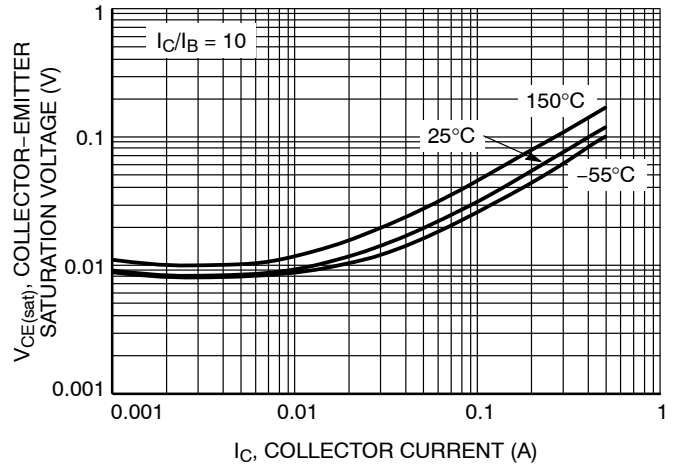

Figure 17. Collector Emitter Saturation Voltage vs. Collector Current

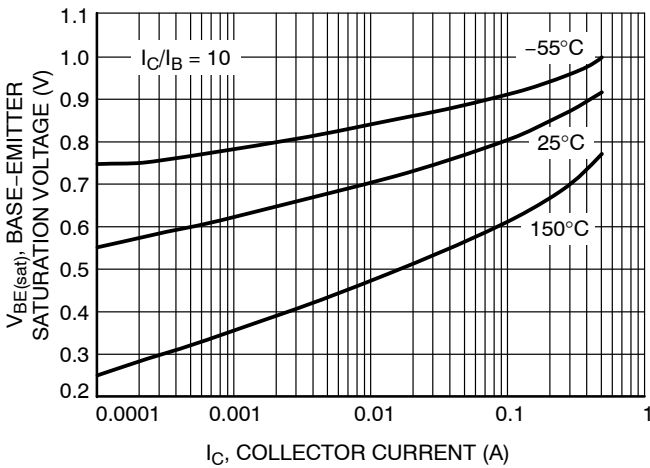

Figure 18. Base Emitter Saturation Voltage vs. Collector Current

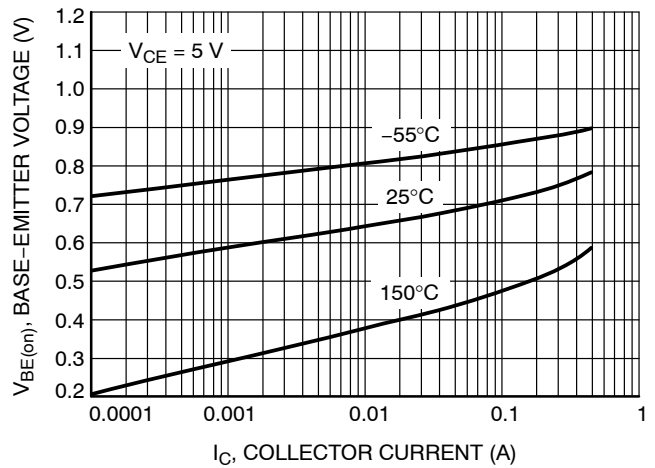

Figure 19. Base Emitter Voltage vs. Collector Current

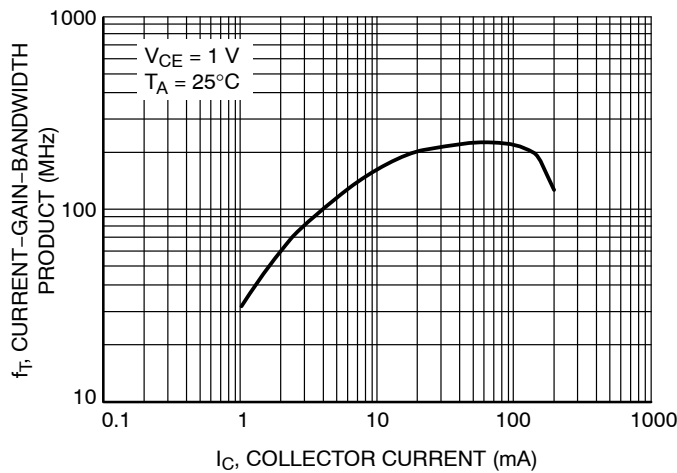

Figure 20. Current Gain Bandwidth Product vs. Collector Current

LBC817-16LT1G LBC817-25LT1G LBC817-40LT1G

TYPICAL CHARACTERISTICS - LBC817-40LT1G

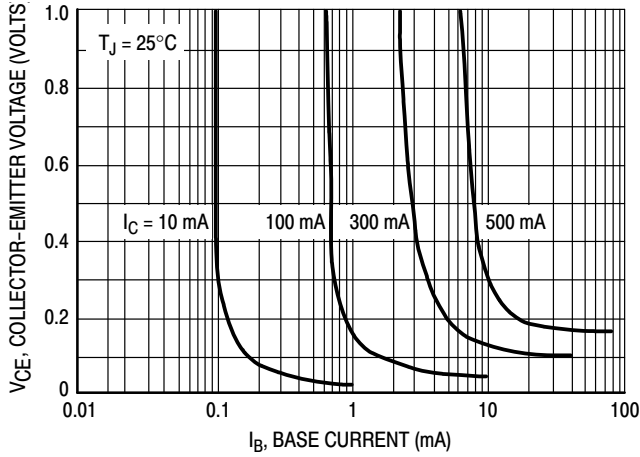

Figure 21. Saturation Region

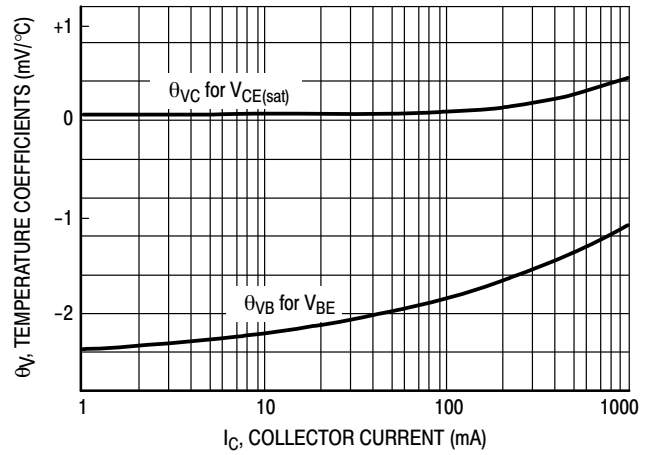

Figure 22. Temperature Coefficients

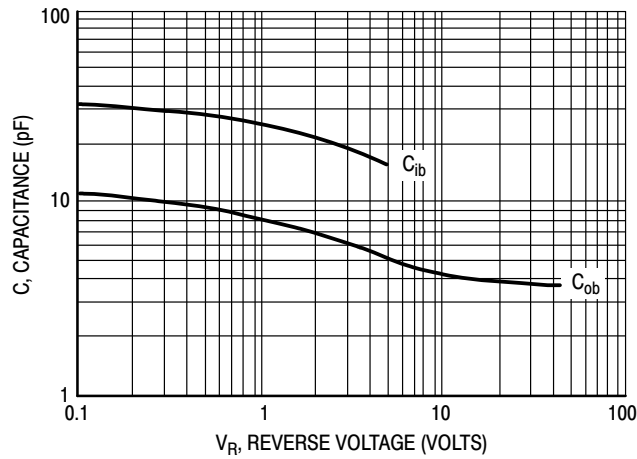
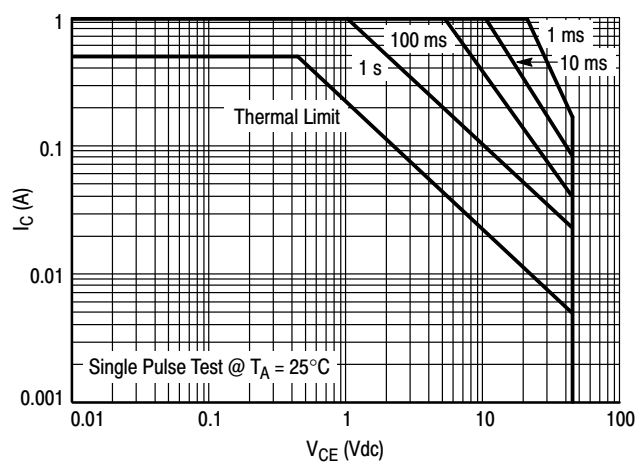

Figure 23. Capacitances



**LBC817-16LT1G LBC817-25LT1G LBC817-40LT1G**
**TYPICAL CHARACTERISTICS – LBC817-16LT1G LBC817-25LT1G LBC817-40LT1G**

**Figure 24. Safe Operating Area**

LBC817-16LT1G LBC817-25LT1G LBC817-40LT1G

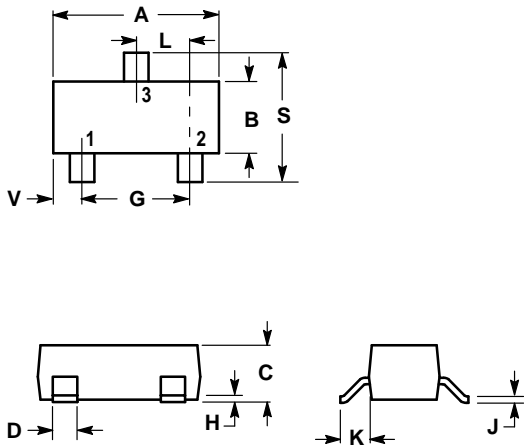
SOT-23



NOTES:

1. DIMENSIONING AND TOLERANCING PER ANSI Y14.5M, 1982.
2. CONTROLLING DIMENSION: INCH.

DIM	INCHES		MILLIMETERS	
	MIN	MAX	MIN	MAX
A	0.1102	0.1197	2.80	3.04
B	0.0472	0.0551	1.20	1.40
C	0.0350	0.0440	0.89	1.11
D	0.0150	0.0200	0.37	0.50
G	0.0701	0.0807	1.78	2.04
H	0.0005	0.0040	0.013	0.100
J	0.0034	0.0070	0.085	0.177
K	0.0140	0.0285	0.35	0.69
L	0.0350	0.0401	0.89	1.02
S	0.0830	0.1039	2.10	2.64
V	0.0177	0.0236	0.45	0.60

- PIN 1. BASE  
 2. EMITTER  
 3. COLLECTOR

