

SUPER MINI ELMC

SERIES

8283

RECEPTACLE

CONTACT

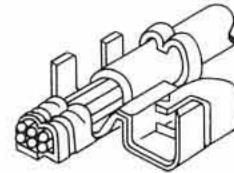
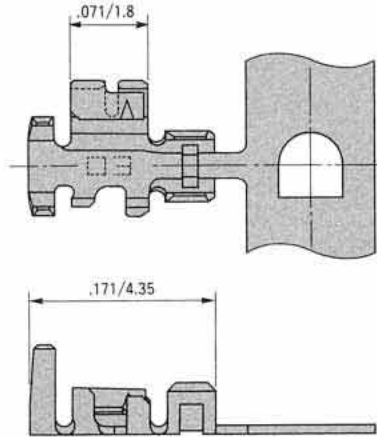

注文コード ORDERING CODE

60 8283 XXXX XX 808

形状 TYPE

形状

型番	形状	適用工具	被覆外型	適用電線範囲
0513 30	キャリアカット状	手動工具	φ 1.3Max.	#24~30
0513 99	連鎖鎖	圧着機		#24~30
3513 30	キャリアカット状	手動工具		#22~26
3513 99	連鎖鎖	圧着機		#22~26
2513 99	連鎖鎖	圧着機	φ 1.0Max.	#32

TYPE

Part Number	Type	Application Tooling	Insulation Diameter	Wire Size
0513 30	Loose	Crimping Pliers	φ 1.3Max.	#24~30
0513 99	Chain	Crimping Machine		#24~30
3513 30	Loose	Crimping Pliers		#22~26
3513 99	Chain	Crimping Machine		#22~26
2513 99	Chain	Crimping Machine	φ 1.0Max.	#32

RECEPTACLE HOUSING

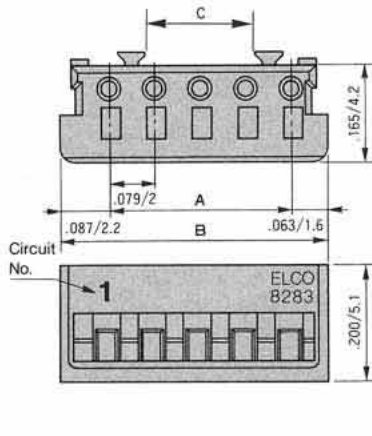

ロック付
2~12極

ロックなし
13~16極

4~16極
リップ2個

3極
リップ1個

2極
リップ1個

With Lock
2~12 Contacts

Without Lock
13~16 Contacts

4~16 Contacts
With 2 Ribs

3 Contacts
With 1 Rib

2 Contacts
With 1 Rib

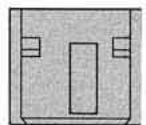
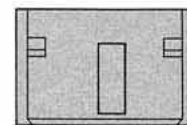
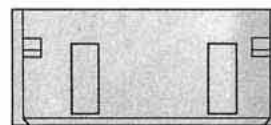
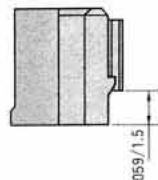

Dimensions inches/mm

カラー-COLOR

000 : 自然色(白) NATURAL (WHITE)

001 : 黒 BLACK

002 : 赤 RED

003 : 黄 YELLOW

★16極は自然色のみ 16P : NATURAL ONLY

極数 NUMBER OF CONTACTS

極数	A	B	C
02	2	5.8	
03	4	7.8	
04	6	9.8	2.8
05	8	11.8	4.8
06	10	13.8	6.8
07	12	15.8	8.8
08	14	17.8	10.8
09	16	19.8	12.8
10	18	21.8	14.8
11	20	23.8	16.8
12	22	25.8	18.8
13	24	27.8	20.8
14	26	29.8	22.8
15	28	31.8	24.8
16	30	33.8	26.8

A=2×(極数-1)

B=2×(極数-1)+3.8

C=2×(極数-1)-3.2

A=2×(NO. OF CONTACTS-1)

B=2×(NO. OF CONTACTS-1)+3.8

C=2×(NO. OF CONTACTS-1)-3.2

注文コード ORDERING CODE

60 8283 3XX8 45 XXX

極数
NUMBER OF CONTACTS

カラー
COLOR

SUPER MINI ELMEC

SERIES

8283 PLUG STRAIGHT

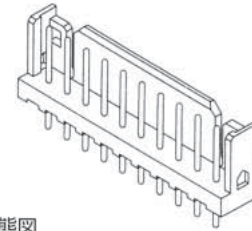
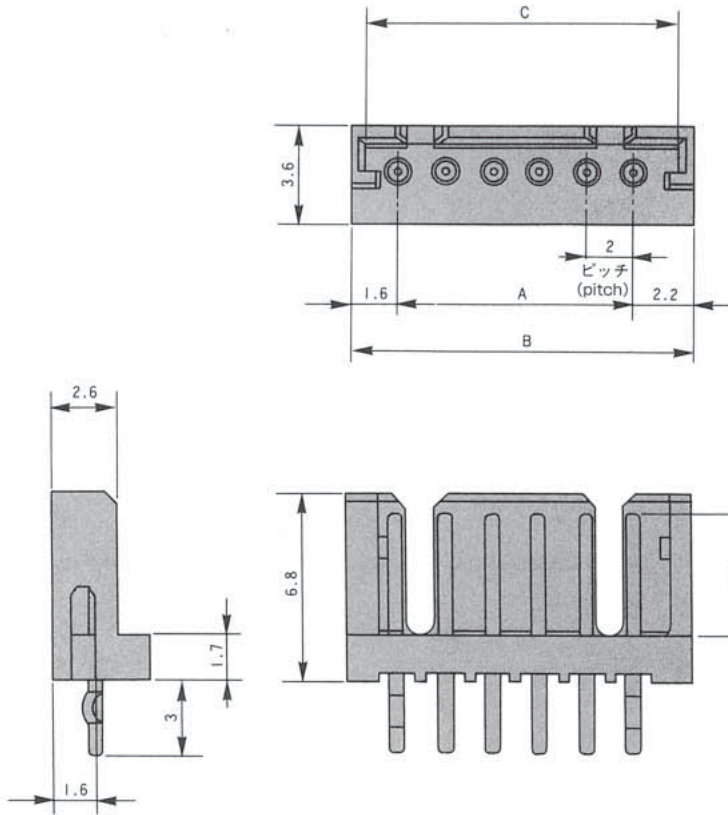

嵌合状態図
(Mating Condition)

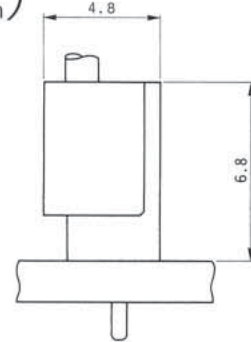

P・Cボード穴寸法 適用基板厚1.2~1.6mm
P.C. BOARD THROUGH HOLE DIMENSION t=1.2~1.6mm

※16極は一部形状が異なりますので、詳細につきましては、弊社営業マンへお問い合わせ下さい。

As16P have difference of Insulator shape compare with another positions, please ask to our sales person about detail issue.

基板穴経 P.W.B HOLE	
E	パンチ穴 PUNCH-HOLE
	ドリル穴 N.C. HOLE
	0.7 ^{+0.1} 0.8 ^{+0.1}



極数 NUMBER OF CONTACTS	A	B	C	マガジン 収納数 (個) NO. OF MAGAZINE PACKAGING (UNITS)
02	2	5.8	5	82
03	4	7.8	7	60
04	6	9.8	9	48
05	8	11.8	11	40
06	10	13.8	13	34
07	12	15.8	15	29
08	14	17.8	17	26
09	16	19.8	19	23
10	18	21.8	21	21
11	20	23.8	23	19
12	22	25.8	25	18
13	24	27.8	27	17
14	26	29.8	29	16
15	28	31.8	31	15
16	30	33.8	33	-

カラー-COLOR

000：自然色(白) NATURAL (WHITE)

001：黒 BLACK

002：赤 RED

003：黄 YELLOW

★16極は自然色のみ 16P：NATURAL ONLY

注文コードORDERING CODE

00 8283 XX 1X 00 XXX +

極数
NUMBER OF CONTACTS
プラグアッセンブリー
PLUG ASSEMBLY
2.ストレート STRAIGHT
4.ストレート16極 STRAIGHT : 16 CONTACTS

カラー
COLOR

A=2×(極数-1) A=2×(NO. OF CONTACTS-1)
B=2×(極数-1)+3.8 B=2×(NO. OF CONTACTS-1)+3.8
C=2×(極数-1)+3 C=2×(NO. OF CONTACTS-1)+3

SUPER MINI ELMEC

SERIES

8283 PLUG RIGHT ANGLE

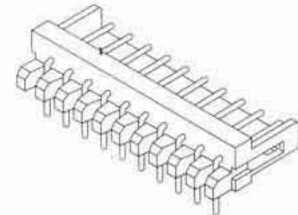
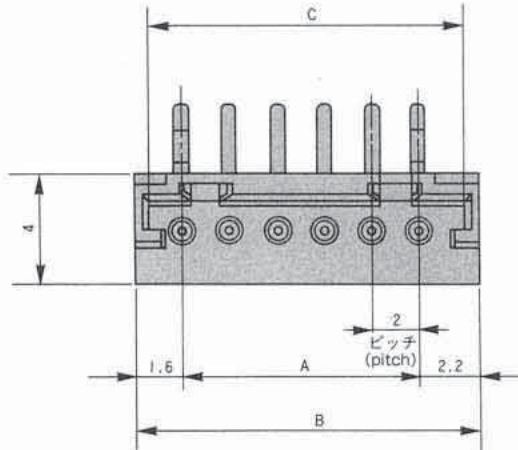

嵌合状態図
MATING CONDITION

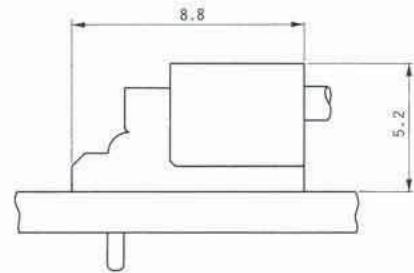
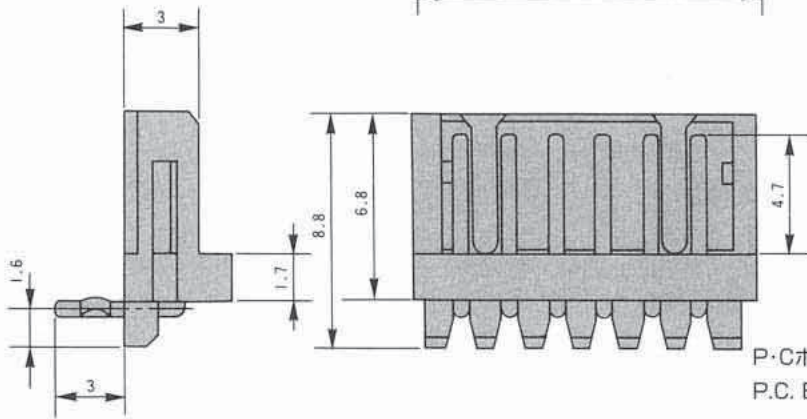

P・Cボード穴寸法 適用基板厚1.2~1.6mm
P.C. BOARD THROUGH HOLE DIMENSION t=1.2~1.6mm

※16極は一部形状が異なりますので、詳細につきましては、弊社営業マンへお問い合わせ下さい。

As16P have difference of Insulator shape compare with another positions, please ask to our sales person about detail issue.

基板穴径 P.W.B HOLE	
E	パンチ穴 PUNCH HOLE
	ドリル穴 D.RILL HOLE
	0.7 ^{±0.02} 0.8 ^{±0.02}

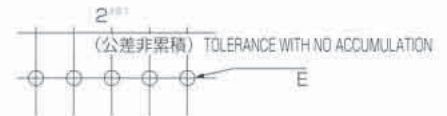

極数 NUMBER OF CONTACTS	A	B	C	マガジン 収納数 (個) NO. OF MAGAZINE PACKAGING (UNITS)
02	2	5.8	5	85
03	4	7.8	7	65
04	6	9.8	9	52
05	8	11.8	11	43
06	10	13.8	13	36
07	12	15.8	15	32
08	14	17.8	17	28
09	16	19.8	19	25
10	18	21.8	21	23
11	20	23.8	23	21
12	22	25.8	25	20
13	24	27.8	27	18
14	26	29.8	29	17
15	28	31.8	31	16
16	30	34.4	33	—

カラーCOLOR

000 : 自然色(白) NATURAL (WHITE)

001 : 黒 BLACK

002 : 赤 RED

003 : 黄 YELLOW

★16極は自然色のみ 16P : NATURAL ONLY

注文コードORDERING CODE

00 8283 XX 1X 00 XXX+

極数
NUMBER OF CONTACTS
プラグアッセンブリー
PLUG ASSEMBLY
1. ライトアングル RIGHT ANGLE
3. ライトアングル16極 RIGHT ANGLE : 16 CONTACTS

カラー
COLOR

※ 16極は、10となります。
ONLY 16CONTACTS=10
EXAMPLE 00 8283 1613 10 000

A=2×(極数-1) A=2×(NO. OF CONTACTS-1)
B=2×(極数-1)+3.8 B=2×(NO. OF CONTACTS-1)+3.8
C=2×(極数-1)+3 C=2×(NO. OF CONTACTS-1)+3

SUPER MINI ELMEC

SERIES

8283

RECEPTACLE BOARD TYPE

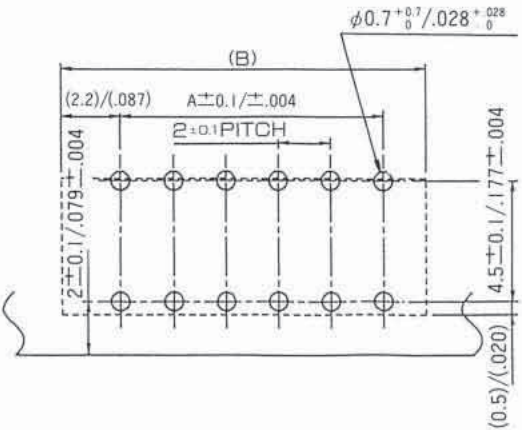
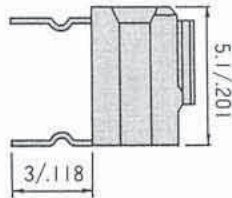
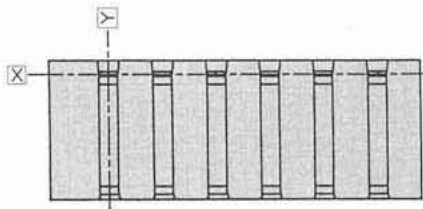
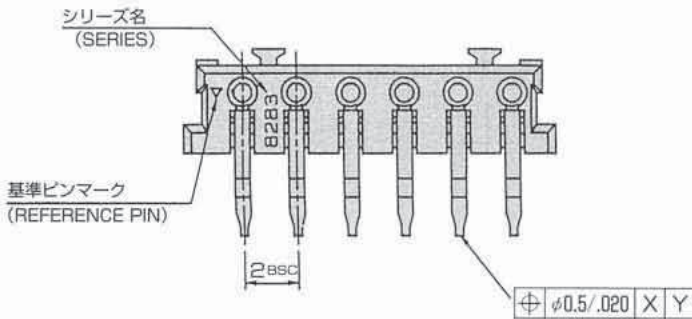

●特長 (Features)

8283プラグとの組合せによりボードツーボードが可能。

Board-to-board mating is made possible by combination with the 8283 plug.

●バリエーション (Variations)

プラグ (ストレート) との組合せで垂直接続。
プラグ (ライトアングル) との組合せで平行接続。

Vertical connection with a straight plug
Parallel connection with a right angle plug.

推奨基板寸法

板厚: 1.2又は、1.6

RECOMMENDED P.C. BOARD

LAYOUT t=1.2~1.6

極数 NUMBER OF CONTACTS	A	B
02	2	5.8
03	4	7.8
04	6	9.8
05	8	11.8
06	10	13.8
07	12	15.8
08	14	17.8
09	16	19.8
10	18	21.8
11	20	23.8
12	22	25.8
13	24	27.8
14	26	29.8
15	28	31.8

注文コード ORDERING CODE

20 8283 0XX 000 000 +

極数
NUMBER OF CONTACTS

カラー
COLOR 000: 自然色(白) NATURAL (WHITE)

SUPER MINI ELMEC

SERIES

8283 I.D.C. RECEPTACLE

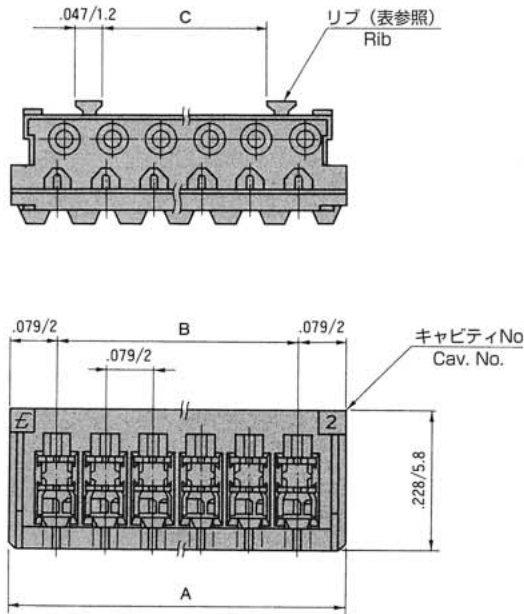

嵌合状態図

MATING CONDITION

ストレート
Straight

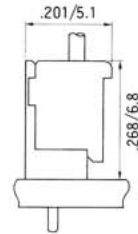

ライトアングル
Right Angle

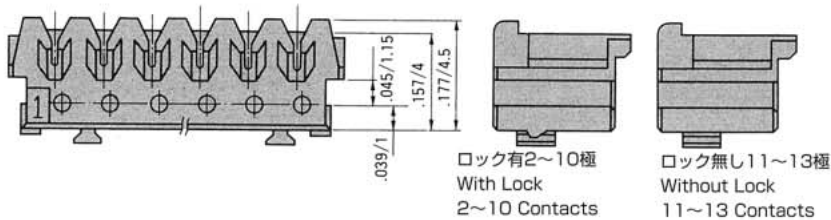
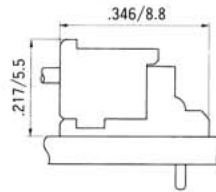

適用電線範囲 APPLICABLE WIRE SIZES

電線サイズ (AWG) WIRE SIZE	電線ULスタイル UL STYLE	絶縁被覆外径 INSULATION DIAMETER	備考 NOTES
AWG#28	1061	0.95±0.05mm	燃り線および鍍コート線 STRADLE AND TIN OVER STRADLE 燃り線 (STRADLE)
	1571	0.90±0.05mm	
	2824	0.95±0.05mm	
	3443	0.90±0.05mm	
AWG#26	1061	1.00±0.05mm	燃り線 (STRADLE)
	1571		

極数 NO. OF CONTACTS	A	B	C	LOCK ○WITH ×WITHOUT	リブの位置 Pos. OF RIB
02	6	2	—	○	1と2極間 BETWEEN 1 AND 2
03	8	4	—	○	2極の位置 POS. OF 2
04	10	6	2.8	○	1と2,3と4極間 BETWEEN 1 AND 2, 3AND 4
05	12	8	4.8	○	1と2,4と5極間 BETWEEN 1 AND 2, 4AND 5
06	14	10	6.8	○	1と2,5と6極間 BETWEEN 1 AND 2, 5AND 6
07	16	12	8.8	○	1と2,6と7極間 BETWEEN 1 AND 2, 6AND 7
08	18	14	10.8	○	1と2,7と8極間 BETWEEN 1 AND 2, 7AND 8
09	20	16	12.8	○	1と2,8と9極間 BETWEEN 1 AND 2, 8AND 9
10	22	18	14.8	○	1と2,9と10極間 BETWEEN 1 AND 2, 9AND 10
11	24	20	16.8	×	1と2,10と11極間 BETWEEN 1 AND 2, 10AND 11
12	26	22	18.8	×	1と2,11と12極間 BETWEEN 1 AND 2, 11AND 12
13	28	24	20.8	×	1と2,12と13極間 BETWEEN 1 AND 2, 12AND 13

注文コード ORDERING CODE

00 8283 XX70 00 808 L

極数
NUMBER OF CONTACTS

メッキコード MATERIAL CODE
808 : スズメッキ TIN-LEAD

SUPER MINI ELMEC

SERIES

8283

I.D.C.
RECEPTACLE

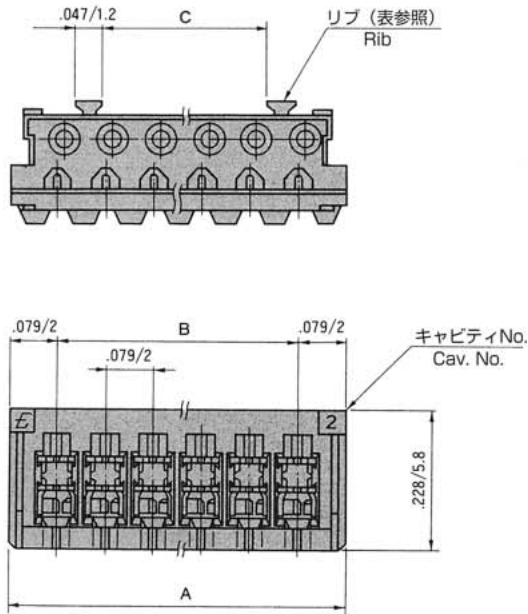

嵌合状態図

MATING CONDITION

ストレート
Straight

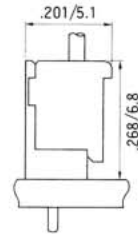

ライトアングル
Right Angle

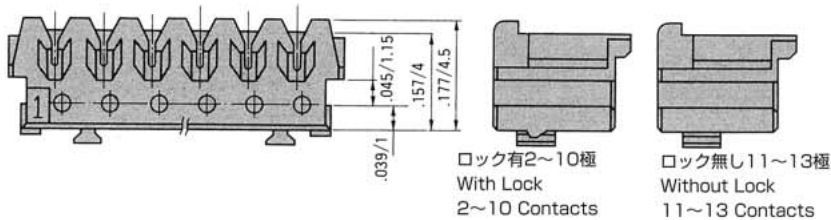
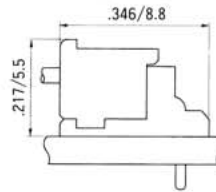

適用電線範囲 APPLICABLE WIRE SIZES

電線サイズ (AWG) WIRE SIZE	電線ULスタイル UL STYLE	絶縁被覆外径 INSULATION DIAMETER	備考 NOTES
AWG#28	1061	0.95±0.05mm	燃り線および鍍コート線 STRADLE AND TIN OVER STRADLE 燃り線 (STRADLE)
	1571	0.90±0.05mm	
	2824	0.95±0.05mm	
	3443	0.90±0.05mm	
AWG#26	1061	1.00±0.05mm	燃り線 (STRADLE)
	1571		

極数 NO. OF CONTACTS	A	B	C	LOCK ○WITH ×WITHOUT	リブの位置 Pos. OF RIB
02	6	2	—	○	1と2極間 BETWEEN 1 AND 2
03	8	4	—	○	2極の位置 POS. OF 2
04	10	6	2.8	○	1と2.3と4極間 BETWEEN 1 AND 2.3AND 4
05	12	8	4.8	○	1と2.4と5極間 BETWEEN 1 AND 2.4AND 5
06	14	10	6.8	○	1と2.5と6極間 BETWEEN 1 AND 2.5AND 6
07	16	12	8.8	○	1と2.6と7極間 BETWEEN 1 AND 2.6AND 7
08	18	14	10.8	○	1と2.7と8極間 BETWEEN 1 AND 2.7AND 8
09	20	16	12.8	○	1と2.8と9極間 BETWEEN 1 AND 2.8AND 9
10	22	18	14.8	○	1と2.9と10極間 BETWEEN 1 AND 2.9AND 10
11	24	20	16.8	×	1と2.10と11極間 BETWEEN 1 AND 2.10AND 11
12	26	22	18.8	×	1と2.11と12極間 BETWEEN 1 AND 2.11AND 12
13	28	24	20.8	×	1と2.12と13極間 BETWEEN 1 AND 2.12AND 13

注文コード ORDERING CODE

00 8283 XX70 00 808 L

極数
NUMBER OF CONTACTS

メッキコード MATERIAL CODE
808 : スズメッキ TIN-LEAD