

PNP Silicon High Voltage Transistors

SXTA 92
SXTA 93

- High breakdown voltage
- Low collector-emitter saturation voltage

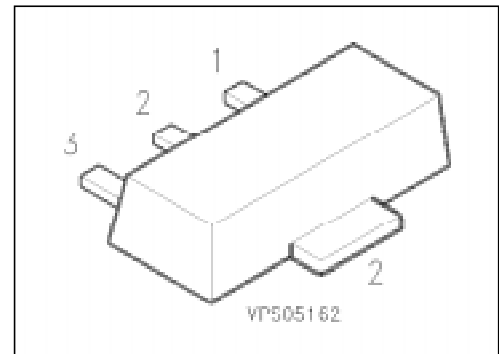

Type	Marking	Ordering Code (tape and reel)	Pin Configuration			Package ¹⁾
			1	2	3	
SXTA 92	2D	Q68000-A8393	B	C	E	SOT-89
SXTA 93	2E	Q68000-A8651				

Maximum Ratings

Parameter	Symbol	Values		Unit
		SXTA 92	SXTA 93	
Collector-emitter voltage	V_{CE0}	300	200	V
Collector-base voltage	V_{CB0}	300	200	
Emitter-base voltage	V_{EB0}	5		
Collector current	I_C	500		mA
Total power dissipation, $T_s = 130\text{ °C}$	P_{tot}	1		W
Junction temperature	T_j	150		°C
Storage temperature range	T_{stg}	- 65 ... + 150		

Thermal Resistance

Junction - ambient ²⁾	$R_{th\ JA}$	≤ 75	K/W
Junction - soldering point	$R_{th\ JS}$	≤ 20	

1) For detailed information see chapter Package Outlines.

2) Package mounted on epoxy pcb 40 mm × 40 mm × 1.5 mm/6 cm² Cu.

Electrical Characteristics

at $T_A = 25\text{ °C}$, unless otherwise specified.

Parameter	Symbol	Values			Unit
		min.	typ.	max.	

DC characteristics

Collector-emitter breakdown voltage $I_C = 1\text{ mA}$	SXTA 92 SXTA 93	$V_{(BR)CE0}$	300 200	– –	– –	V
Collector-base breakdown voltage $I_C = 100\text{ }\mu\text{A}$	SXTA 92 SXTA 93	$V_{(BR)CB0}$	300 200	– –	– –	
Emitter-base breakdown voltage $I_E = 100\text{ }\mu\text{A}$		$V_{(BR)EB0}$	5	–	–	
Collector-base cutoff current $V_{CB} = 200\text{ V}, I_E = 0$ $V_{CB} = 160\text{ V}, I_E = 0$ $V_{CB} = 200\text{ V}, I_E = 0, T_A = 125\text{ °C}$ $V_{CB} = 160\text{ V}, I_E = 0, T_A = 125\text{ °C}$	SXTA 92 SXTA 93 SXTA 92 SXTA 93	I_{CB0}	– – – –	– – – –	250 250 20 20	nA nA μA μA
Emitter-base cutoff current $V_{EB} = 4\text{ V}, I_C = 0$		I_{EB0}	–	–	100	nA
DC current gain $I_C = 1\text{ mA}, V_{CE} = 10\text{ V}$ $I_C = 10\text{ mA}, V_{CE} = 10\text{ V}$ $I_C = 30\text{ mA}, V_{CE} = 10\text{ V}$	SXTA 92 SXTA 93	h_{FE}	25 40 25 25	– – – –	– – – –	–
Collector-emitter saturation voltage ¹⁾ $I_C = 20\text{ mA}, I_B = 2\text{ mA}$	SXTA 92 SXTA 93	V_{CEsat}	– –	– –	0.5 0.4	V
Base-emitter saturation voltage ¹⁾ $I_C = 20\text{ mA}, I_B = 2\text{ mA}$		V_{BEsat}	–	–	0.9	

AC characteristics

Transition frequency $I_C = 10\text{ mA}, V_{CE} = 20\text{ V}, f = 100\text{ MHz}$		f_T	50	–	–	MHz
Output capacitance $V_{CB} = 20\text{ V}, f = 1\text{ MHz}$	SXTA 92 SXTA 93	C_{obo}	– –	– –	6 8	pF

¹⁾ Pulse test conditions: $t \leq 300\text{ }\mu\text{s}, D \leq 2\%$.

Total power dissipation $P_{tot} = f(T_A^*; T_S)$
 * Package mounted on epoxy

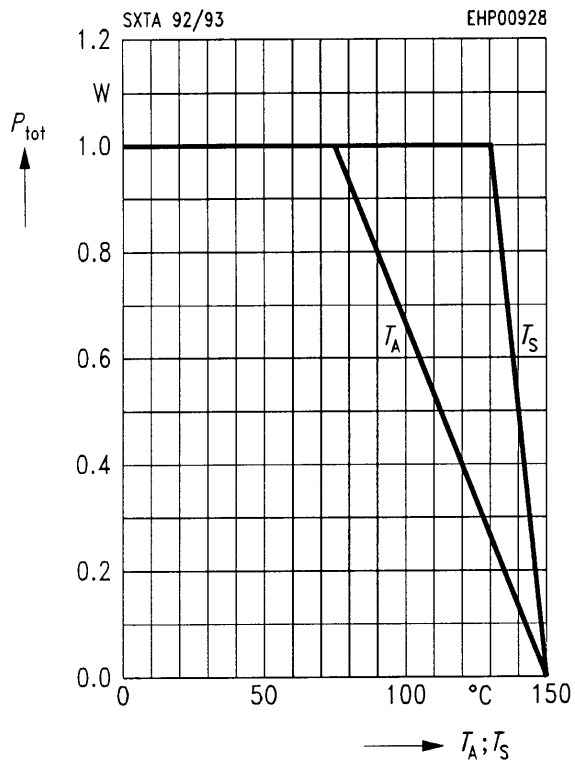

Transition frequency $f_T = f(I_C)$
 $V_{CE} = 20\text{ V}, f = 100\text{ MHz}$

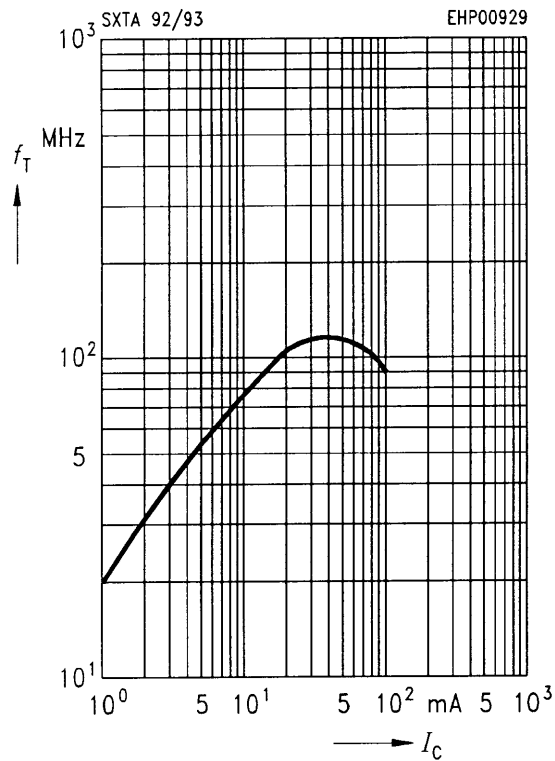

Permissible pulse load $P_{tot\ max}/P_{tot\ DC} = f(t_p)$

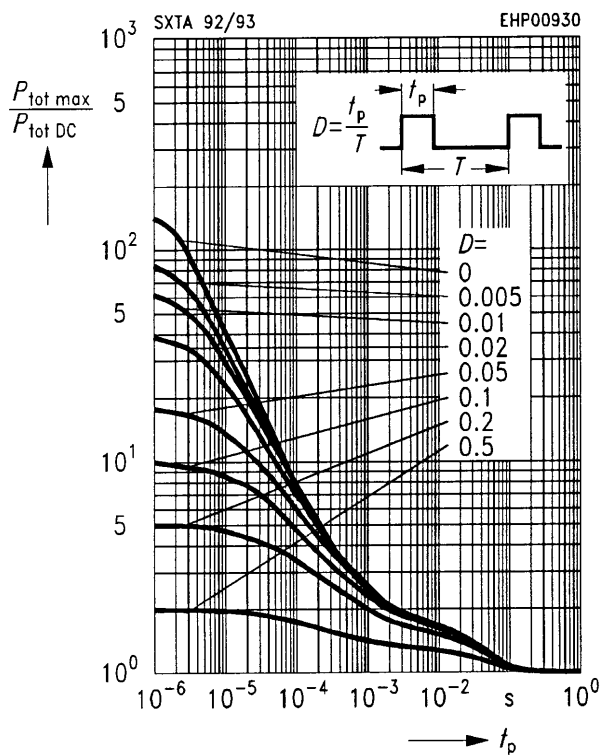

Operating range $I_C = f(V_{CE0})$
 $T_A = 25\text{ °C}, D = 0$

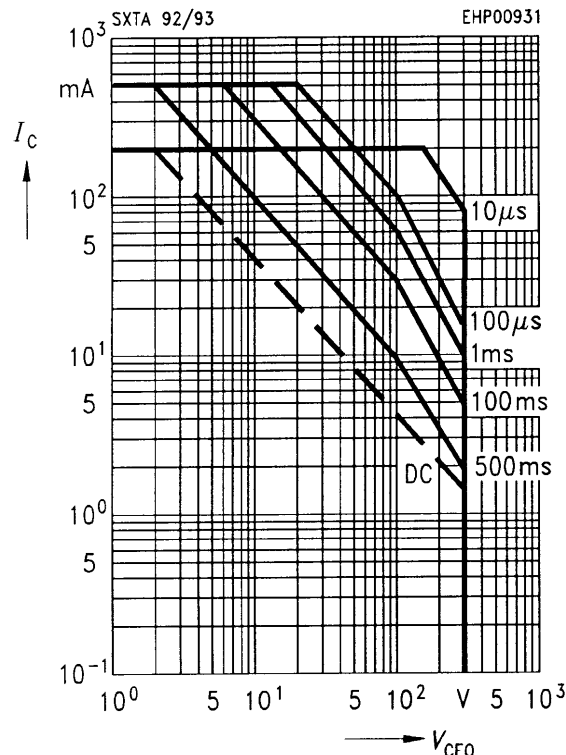

Collector cutoff current $I_{CB0} = f(T_A)$
 $V_{CB} = 160 \text{ V}$

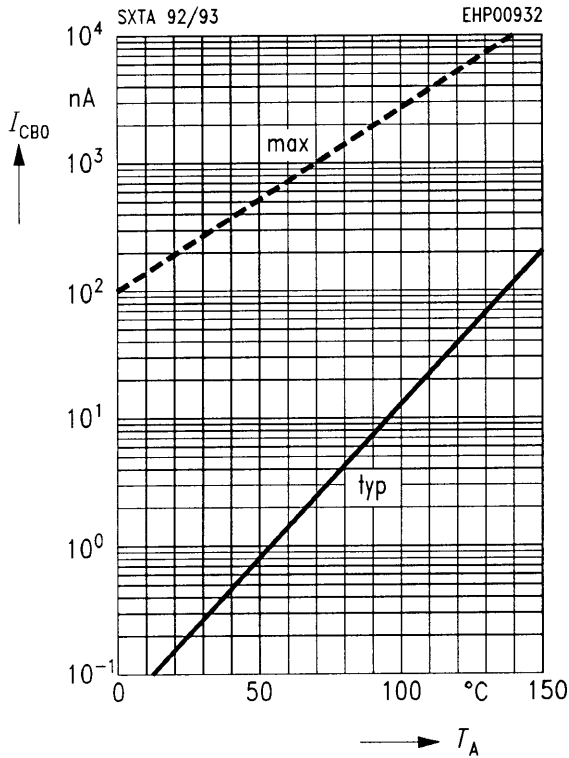

Collector current $I_C = f(V_{BE})$
 $V_{CE} = 10 \text{ V}$

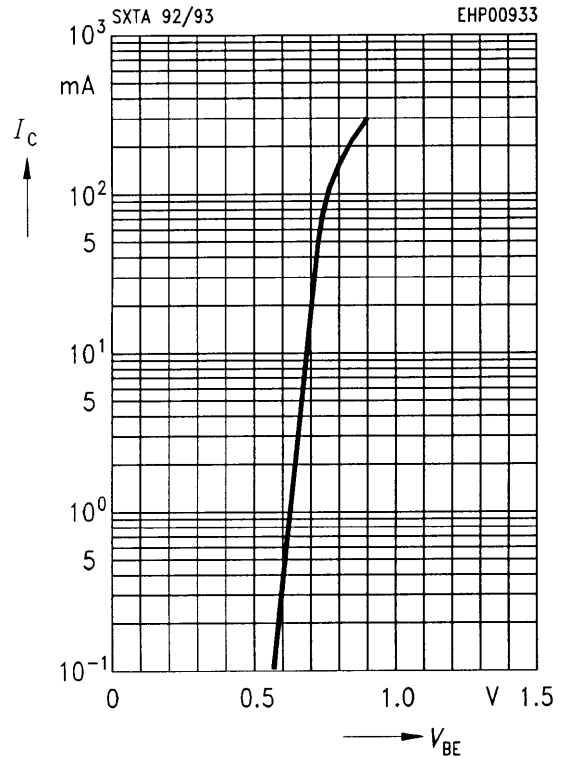

DC current gain $h_{FE} = f(I_C)$
 $V_{CE} = 10 \text{ V}$

