

APT5025HN	500V	21.0A	0.25Ω
APT4525HN	450V	21.0A	0.25Ω
APT5030HN	500V	19.0A	0.30Ω
APT4530HN	450V	19.0A	0.30Ω

POWER MOS IV™

N - CHANNEL ENHANCEMENT MODE HIGH VOLTAGE POWER MOSFETS

MAXIMUM RATINGS

All Ratings: $T_C = 25^\circ\text{C}$ unless otherwise specified.

Symbol	Parameter	APT 4525HN	APT 5025HN	APT 4530HN	APT 5030HN	UNIT
V_{DSS}	Drain-Source Voltage	450	500	450	500	Volts
I_D	Continuous Drain Current @ $T_C = 25^\circ\text{C}$	21.0		19.0		Amps
I_{DM}	Pulsed Drain Current ①	84		76		
V_{GS}	Gate-Source Voltage	±30				Volts
P_D	Total Power Dissipation @ $T_C = 25^\circ\text{C}$	250				Watts
	Linear Derating Factor	2.0				W/°C
T_J, T_{STG}	Operating and Storage Junction Temperature Range	-55 to 150				°C
T_L	Lead Temperature: 0.063" from Case for 10 Sec.	300				

STATIC ELECTRICAL CHARACTERISTICS

Symbol	Characteristic / Test Conditions / Part Number	MIN	TYP	MAX	UNIT
BV_{DSS}	Drain-Source Breakdown Voltage ($V_{GS} = 0V, I_D = 250 \mu\text{A}$)	APT5025HN / APT5030HN		500	Volts
		APT4525HN / APT4530HN		450	
$I_{D(ON)}$	On State Drain Current ② ($V_{DS} > I_{D(ON)} \times R_{DS(ON)}$ Max, $V_{GS} = 10V$)	APT5025HN / APT4525HN		21.0	Amps
		APT5030HN / APT4530HN		19.0	
$R_{DS(ON)}$	Drain-Source On-State Resistance ② ($V_{GS} = 10V, 0.5 I_{D(ON)}$)	APT5025HN / APT4525HN		0.25	Ohms
		APT5030HN / APT4530HN		0.30	
I_{DSS}	Zero Gate Voltage Drain Current ($V_{DS} = V_{DSS}, V_{GS} = 0V$)			250	μA
	Zero Gate Voltage Drain Current ($V_{DS} = 0.8 V_{DSS}, V_{GS} = 0V, T_C = 125^\circ\text{C}$)			1000	
I_{GSS}	Gate-Source Leakage Current ($V_{GS} = \pm 30V, V_{DS} = 0V$)			±100	nA
$V_{GS(TH)}$	Gate Threshold Voltage ($V_{DS} = V_{GS}, I_D = 1.0\text{mA}$)	2		4	Volts

THERMAL CHARACTERISTICS

Symbol	Characteristic	MIN	TYP	MAX	UNIT
$R_{\theta JC}$	Junction to Case			0.50	°C/W
$R_{\theta JA}$	Junction to Ambient			40	

405 S.W. COLUMBIA STREET
BEND, OREGON 97702-1035
U.S.A.

PHONE . . . (503) 382-8028

FAX (503) 388-0364

DYNAMIC CHARACTERISTICS

APT5025/4525/5030/4530HN

Symbol	Characteristic	Test Conditions	MIN	TYP	MAX	UNIT
C_{DC}	Drain-to-Case Capacitance	$f = 1 \text{ MHz}$		24	36	pF
C_{iss}	Input Capacitance	$V_{GS} = 0V$		2410	2950	
C_{oss}	Output Capacitance	$V_{DS} = 25V$		475	665	
C_{rss}	Reverse Transfer Capacitance	$f = 1 \text{ MHz}$		180	270	
Q_g	Total Gate Charge ③	$V_{GS} = 10V$		83	130	nC
Q_{gs}	Gate-Source Charge	$V_{DD} = 0.5 V_{DSS}$		12.6	19	
Q_{gd}	Gate-Drain ("Miller") Charge	$I_D = I_D [\text{Cont.}] @ 25^\circ\text{C}$		51	76	
$t_d(\text{on})$	Turn-on Delay Time	$V_{GS} = 15V$		14	28	ns
t_r	Rise Time	$V_{DD} = 0.5 V_{DSS}$		18	36	
$t_d(\text{off})$	Turn-off Delay Time	$I_D = I_D [\text{Cont.}] @ 25^\circ\text{C}$		60	90	
t_f	Fall Time	$R_G = 1.8\Omega$		18	36	

SOURCE-DRAIN DIODE RATINGS AND CHARACTERISTICS

Symbol	Characteristic / Test Conditions	MIN	TYP	MAX	UNIT
I_S	Continuous Source Current (Body Diode)	APT5025HN / APT4525HN		21	Amps
		APT5030HN / APT4530HN		19	
I_{SM}	Pulsed Source Current ① (Body Diode)	APT5025HN / APT4525HN		84	Amps
		APT5030HN / APT4530HN		76	
V_{SD}	Diode Forward Voltage ② ($V_{GS} = 0V, I_S = -I_D [\text{Cont.}]$)			1.3	Volts
t_{rr}	Reverse Recovery Time ($I_S = -I_D [\text{Cont.}], di_S/dt = 100A/\mu s$)	160	320	640	ns
Q_{rr}	Reverse Recovery Charge ($I_S = -I_D [\text{Cont.}], di_S/dt = 100A/\mu s$)	2.7	5.5	11	μC

SAFE OPERATING AREA CHARACTERISTICS

Symbol	Characteristic	Test Conditions	MIN	TYP	MAX	UNIT
SOA1	Safe Operating Area	$V_{DS} = 0.4 V_{DSS}, I_{DS} = P_D / 0.4 V_{DSS}, t = 1 \text{ Sec.}$	250			Watts
SOA2	Safe Operating Area	$I_{DS} = I_D [\text{Cont.}], V_{DS} = P_D / I_D [\text{Cont.}], t = 1 \text{ Sec.}$	250			
I_{LM}	Inductive Current Clamped	APT5025HN / APT4525HN		84		Amps
		APT5030HN / APT4530HN		76		

① Repetitive Rating: Pulse width limited by maximum junction temperature. See Transient Thermal Impedance Curve. (Fig. 1)

② Pulse Test: Pulse width < 380 μs , Duty Cycle < 2%

③ See MIL-STD-750 Method 3471

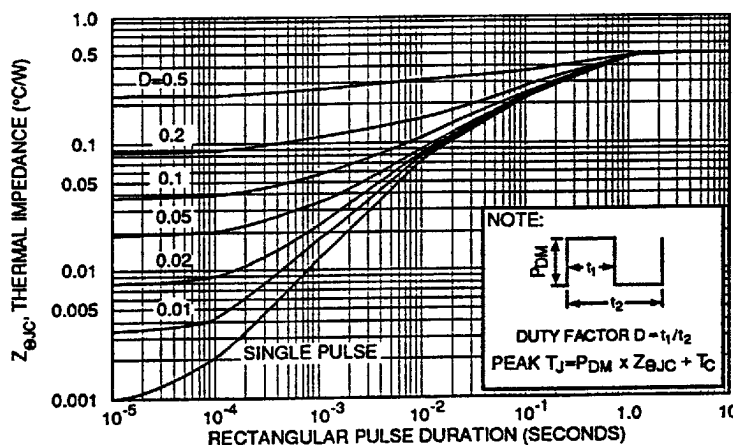

FIGURE 1, MAXIMUM EFFECTIVE TRANSIENT THERMAL IMPEDANCE, JUNCTION-TO-CASE vs PULSE DURATION

APT5025/4525/5030/4530HN

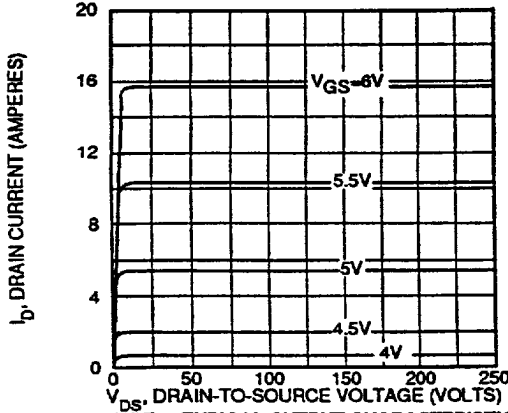

FIGURE 2, TYPICAL OUTPUT CHARACTERISTICS

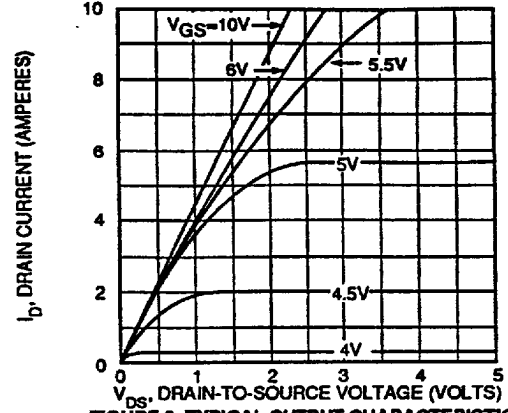

FIGURE 3, TYPICAL OUTPUT CHARACTERISTICS

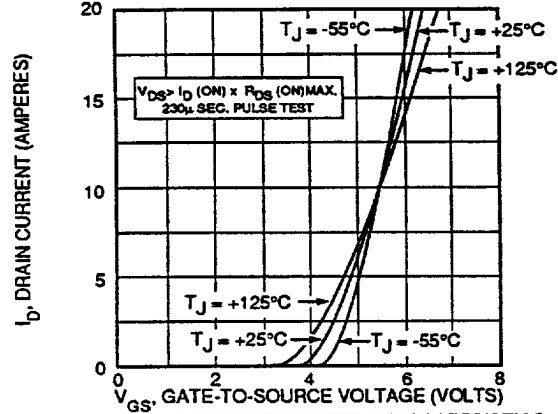

FIGURE 4, TYPICAL TRANSFER CHARACTERISTICS

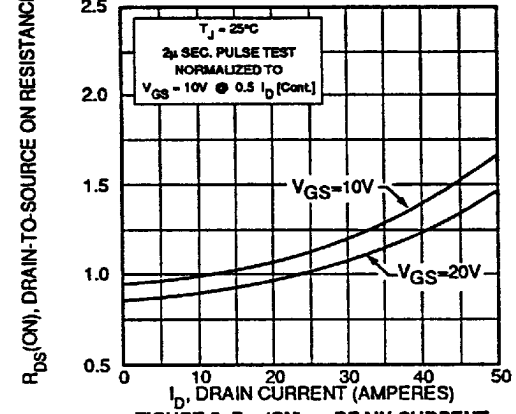

FIGURE 5, $R_{DS(ON)}$ vs DRAIN CURRENT

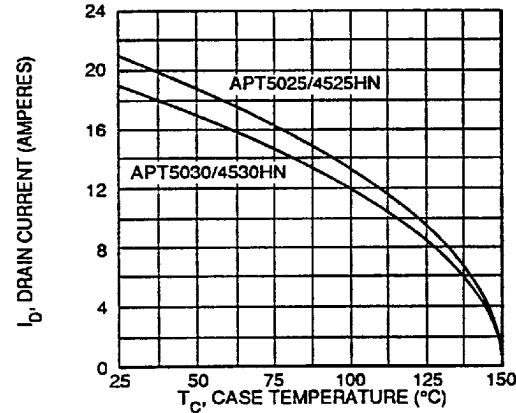

FIGURE 6, MAXIMUM DRAIN CURRENT vs CASE TEMPERATURE

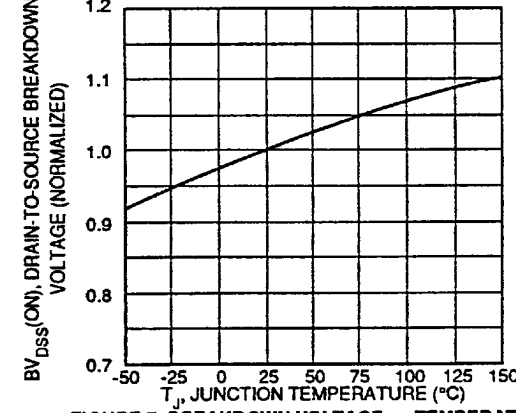

FIGURE 7, BREAKDOWN VOLTAGE vs TEMPERATURE

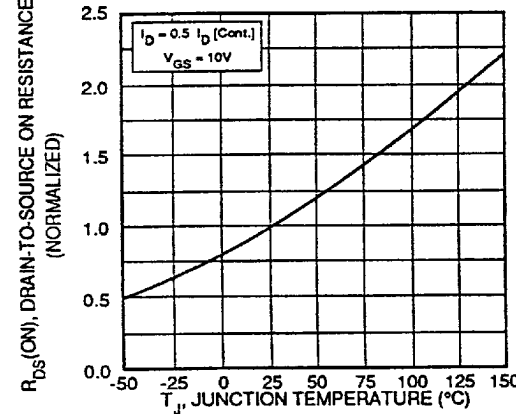

FIGURE 8, ON-RESISTANCE vs. TEMPERATURE

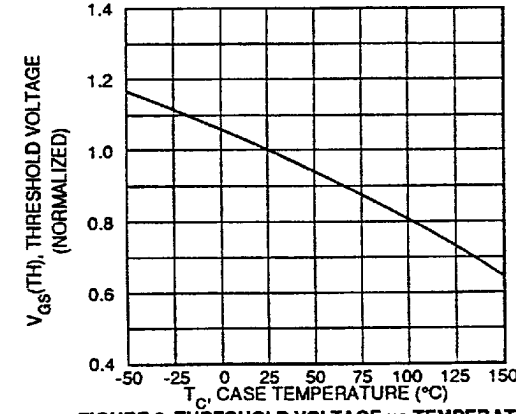

FIGURE 9, THRESHOLD VOLTAGE vs TEMPERATURE

3

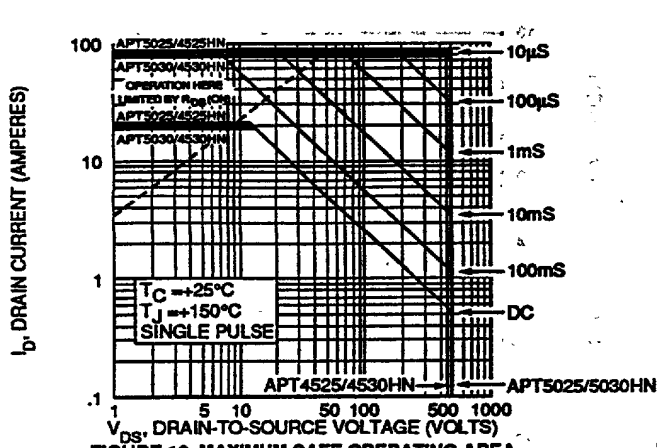

FIGURE 10, MAXIMUM SAFE OPERATING AREA

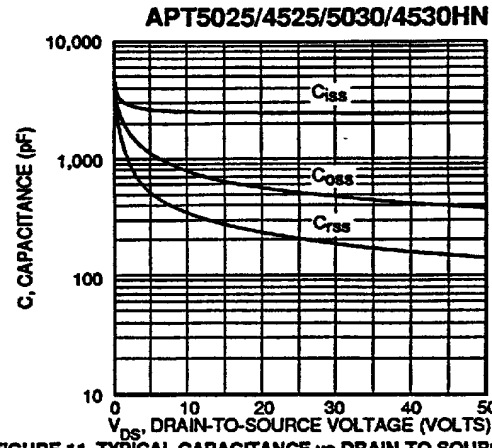

FIGURE 11, TYPICAL CAPACITANCE vs DRAIN-TO-SOURCE VOLTAGE

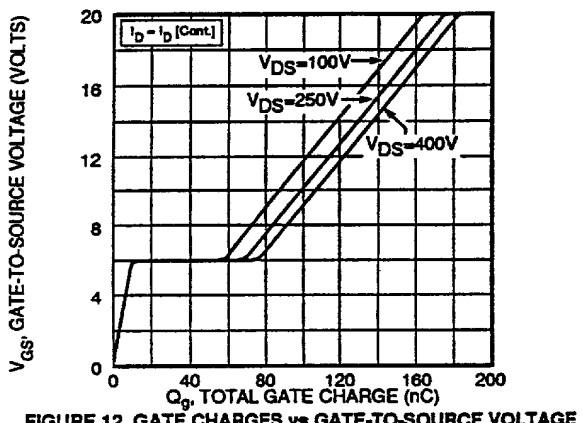

FIGURE 12, GATE CHARGES vs GATE-TO-SOURCE VOLTAGE

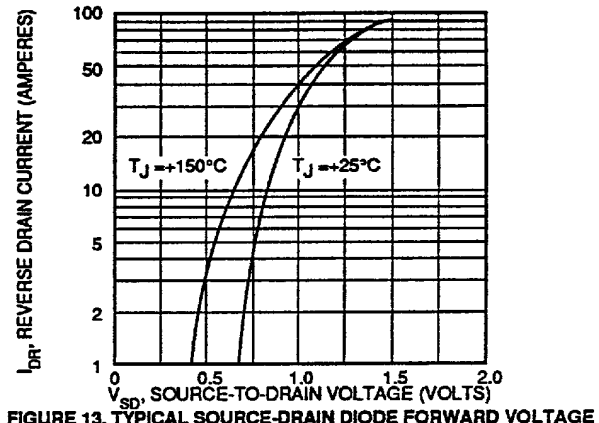
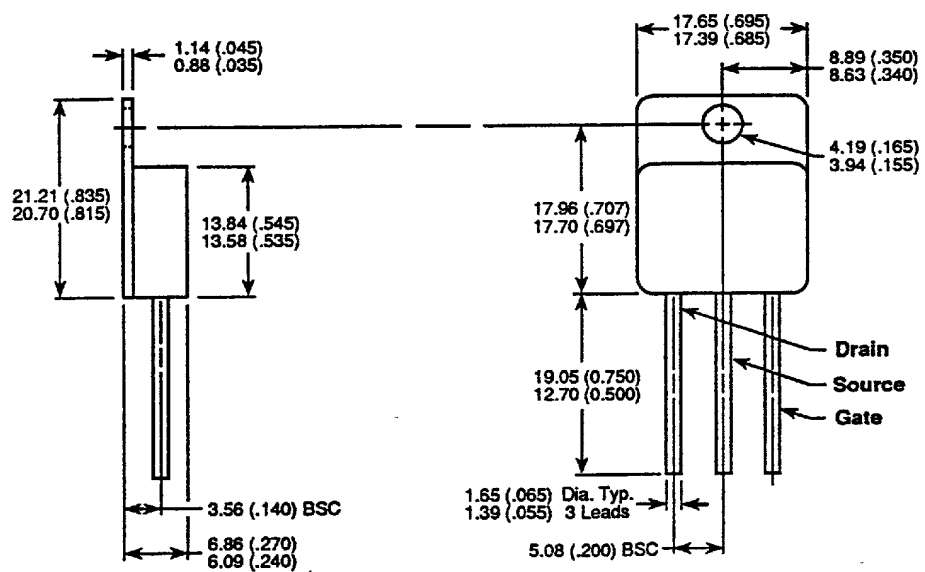

FIGURE 13, TYPICAL SOURCE-DRAIN DIODE FORWARD VOLTAGE

TO-258AA Package Outline



Dimensions in Millimeters and (Inches)

050-5013 Rev A

4