



PROPRIETARY NOTE

THIS SPECIFICATION IS THE PROPERTY OF HEI AND SHALL NOT BE REPRODUCED OR COPIED WITHOUT THE WRITTEN PERMISSION OF HEI AND MUST BE RETURNED TO HEI UPON ITS REQUEST.

HT14X11-103

Product Specification

Rev. C

LCD SBU
Hyundai Electronics Industries Co.,Ltd.

SPEC. NUMBER S864-1015	PRODUCT GROUP TFT-LCD PRODUCT	REV. C	ISSUE DATE 1999.10.11	PAGE OF 1 / 21
----------------------------------	---	------------------	---------------------------------	--------------------------

	PRODUCT GROUP		REV.	ISSUE DATE
	TFT-LCD PRODUCT		C	1999.10.11
REVISION HISTORY				
REV.	ECN NO.	DESCRIPTION OF CHANGES	DATE	PREPARED
0		Initial Release	98.3.10	S.K.Kim
A	E811-F006	Update for Electrical Spec	98.11.10	J.K.Park
B	E901-F012	Update for Electrical Spec	99.01.27	J.K.Park
C	E910-F007	- Correct Erratum, Company name(cover) and definition of light leakage(10.4) - Delete Table 5	99.10.11	S.Y.Kim
SPEC. NUMBER S864-1015		SPEC. TITLE HT14X11-103 Product Specification for TFT-LCD		PAGE OF 2 / 21

	PRODUCT GROUP	REV.	ISSUE DATE
	TFT-LCD PRODUCT	C	1999.10.11

Contents

	Page
1.0 General Description	4
2.0 Absolute Maximum Ratings	5
3.0 Electrical Specifications	6
4.0 Optical Specifications	7
5.0 Interface Connection	9
6.0 Signal Timing Specifications	10
7.0 Signal Timing Waveforms	11
8.0 Input Signals, Basic Display Colors & Gray Scale of Colors..	12
9.0 Power Sequence	13
10.0 Mechanical Characteristics	14
11.0 Reliability Test	15
12.0 Handling & Cautions	16
13.0 Appendix	17

SPEC. NUMBER S864-1015	SPEC. TITLE HT14X11-103 Product Specification for TFT-LCD	PAGE OF 3 / 21
----------------------------------	--	--------------------------

1.0 GENERAL DESCRIPTION

1.1 Introduction

HT14X11-103 is a color active matrix TFT LCD module using amorphous silicon TFT's (Thin Film Transistors) as an active switching devices. This module has a 14.1 inch diagonally measured active area with XGA resolutions (1024 horizontal by 768 vertical pixel array). Each pixel is divided into RED, GREEN, BLUE dots which are arranged in vertical stripe and this module can display 262,144 colors. The TFT-LCD panel used for this module is a low reflection and higher color type. Therefore, this module is suitable for Notebook PC. The DC/AC inverter for back-light driving is not built in this model.

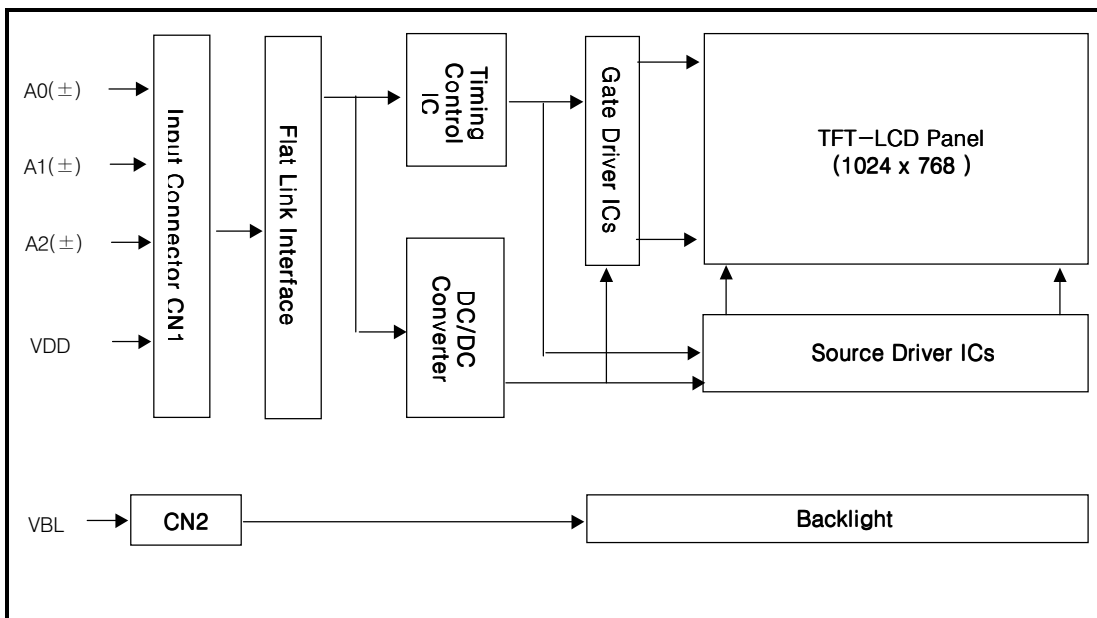

1.2 Features

- Low driving voltage and low power consumption
- Thin and light weight
- 3.3 V power supply
- 1 Channel LVDS Interface (Flat Link, Ti)
- Single CCFL (Bottom side/Horizontal Direction)
- 262,144 colors
- Data Enable Mode (Default) / Sync Mode (Option)

	PRODUCT GROUP	REV.	ISSUE DATE
	TFT-LCD PRODUCT	C	1999.10.11

1.3 General Specifications

The followings are general specifications at the model HT14X11-103. (listed in Table 1.)

<Table 1. General Specifications>

Parameter	Specification	Unit	Remarks
Active area	285.696 (H) x 214.272(V)	mm	
Number of pixels	1024(H) x 768(V)	pixels	
Pixel pitch	0.279(H) x 0.279(V)	mm	
Pixel arrangement	RGB Vertical stripe		
Display colors	262,144	colors	
Display mode	Normally white		
Dimensional outline	300.5 ± 0.5(H) x 227.0 ± 0.5 (V) x 7.0(D) Typ.	mm	
Weight	630 Typ.	g	
Back-light	CCFL, Horizontal-lamp type		Note 1

Note 1: CCFL (Cold Cathode Fluorescent Lamp)

2.0 ABSOLUTE MAXIMUM RATINGS

The followings are maximum values which, if exceed, may cause faulty operation or damage to the unit. The operational and non-operational maximum voltage and current values are listed in Table 2.

< Table 2. Absolute Maximum Ratings>

Parameter	Symbol	Min.	Max.	Unit	Remarks
Power Supply Voltage	V _{DD}	-0.3	4.6	V	
Logic Input Voltage	V _{IN}	-0.3	V _{DD} +0.3	V	
Operating Temperature	T _{OP}	0	+50	°C	
Storage Temperature	T _{SP}	-20	+60	°C	
Back-light Lamp Current	IBL	-	6.0	mA	

SPEC. NUMBER S864-1015	SPEC. TITLE HT14X11-103 Product Specification for TFT-LCD	PAGE OF 5 / 21
---------------------------	---	-------------------

	PRODUCT GROUP	REV.	ISSUE DATE
	TFT-LCD PRODUCT	C	1999.10.11

3.0 ELECTRICAL SPECIFICATIONS

3.1 Electrical Specifications

< Table 3. Electrical specifications >

Parameter		Min.	Typ.	Max.	Unit	Remarks
Power Supply Voltage	V _{DD}	3.0	3.3	3.6	V	Note 1
Power Supply Current	I _{DD}		410	-	mA	Note 1
High Level Input Signal Voltage	V _{IH}	0.7VDD	-	-	V	Note 2
Low Level Input Signal Voltage	V _{IL}			0.3VDD	V	Note 2
Back-light Lamp Voltage	V _{BL}		680		V _{rms}	Note 3
Back-light Lamp Current	I _{BL}	2.0	4.5	6.0	mA _{rms}	
Back-light Lamp operating Frequency	F _L	40	(50)	70	KHz	Note 4 One Lamp
Lamp Starting Voltage	Ta = 25°C		-	755	V _{rms}	Note 5
	Ta = 0°C		-	1070	V _{rms}	Note 5
Lamp Life		10,000	15,000		hrs	At I _{BL} = 6.0 mA
Power Consumption	P _D		1.4		W	Typ.@8 Color Bar
	P _{BL}		3.1		W	Note 6
	P _{total}		4.5		W	

Notes : 1. The supply voltage is measured and specified at the interface connector of LCM.

The current draw and power consumption specified is for 3.3V at 25°C.

2. The values specified apply to all logic inputs.

: ENAB, Clock, Data Signals, etc. are serial input signal. (See Ref. 7.2.)

3. Reference value, which is measured with Harison HIU-742A Inverter at 25°C

(V_{BLMIN} is value at I_{BLMIN} and V_{BLMAX} is at I_{BLMAX}.)

4. The lamp frequency should be selected as different as possible from the horizontal synchronous frequency and its harmonics to avoid interference which may cause line flow on the display

5. The inverter open voltage should be more than the maximum value of lamp starting voltage.

SPEC. NUMBER S864-1015	SPEC. TITLE HT14X11-103 Product Specification for TFT-LCD	PAGE OF 6 / 21
---------------------------	---	-------------------

	PRODUCT GROUP	REV.	ISSUE DATE
	TFT-LCD PRODUCT	C	1999.10.11

6. Calculated value for reference ($V_{BL} \times I_{BL}$)

4.0 OPTICAL SPECIFICATIONS

4.1 Overview

The test of optical specifications shall be measured in a dark room (ambient luminance ≤ 1 lux and temperature = $25 \pm 2^\circ\text{C}$) with the equipment of Luminance meter system (Goniometer system and TOPCONE BM-5) and test unit shall be located at a distance 50cm from the LCD surface at a viewing angle of θ and Φ equal to 0° . We refer to $\theta_{\theta=0}$ ($=\theta_3$) as the 3 o'clock direction (the "right"), $\theta_{\theta=90}$ ($=\theta_{12}$) as the 12 o'clock direction ("upward"), $\theta_{\theta=180}$ ($=\theta_9$) as the 9 o'clock direction ("left") and $\theta_{\theta=270}$ ($=\theta_6$) as the 6 o'clock direction ("bottom"). While scanning θ and/or Φ , the center of the measuring spot on the display surface shall stay fixed. The measurement shall be executed after 30 minutes warm-up period. VDD shall be $3.3 \pm 0.15\text{V}$ at 25°C . Optimum viewing angle direction is 6 o'clock.

4.2 Optical Specifications

<Table 4. Optical Specifications>

Parameter		Symbol	Condition	Min.	Typ.	Max.	Unit	Remark
Viewing Angle Range	Horizontal	θ_3	CR > 10	40			Deg.	Note 1
		θ_9		40			Deg.	
	Vertical	θ_{12}		10			Deg.	
		θ_6		35			Deg.	
Luminance Contrast Ratio		CR	$\theta = 0^\circ$	150				Note 2
Average Luminance of White		Y_w	$\theta = 0^\circ$ IBL = 4.5mA		100		cd/m ²	Note 3
White Luminance Uniformity		ΔY				1.25		Note 4
White Chromaticity		x_w	$\theta = 0^\circ$	0.291	0.321	0.351		Note 5
		y_w		0.315	0.345	0.375		
Reproduction of Color	Red	x_R	$\theta = 0^\circ$	0.542	0.572	0.602		
		y_R		0.317	0.347	0.377		
	Green	x_G		0.273	0.303	0.333		
		y_G		0.516	0.546	0.576		
	Blue	x_B		0.118	0.148	0.178		
		y_B		0.112	0.142	0.172		
Response Time	Rise	T_r	$T_a = 25^\circ\text{C}$			40	ms	Note 6
	Decay	T_d	$\theta = 0^\circ$			40	ms	
Cross Talk		CT	$\theta = 0^\circ$			2.0	%	Note 7

SPEC. NUMBER S864-1015	SPEC. TITLE HT14X11-103 Product Specification for TFT-LCD	PAGE OF 7 / 21
---------------------------	---	-------------------

	PRODUCT GROUP	REV.	ISSUE DATE
	TFT-LCD PRODUCT	C	1999.10.11

Note:

1. Viewing Angle is the angle at which the contrast ratio is greater than 10. The Viewing Angles are determined for the horizontal or 3, 9 o'clock direction and the vertical or 6, 12 o'clock direction with respect to the optical axis which is normal to the LCD surface (see FIGURE1 shown in Appendix).
2. Contrast measurements shall be made at viewing angle of $\theta = 0^\circ$ and at the center of the LCD surface. Luminance shall be measured with all pixels in the view field set first to white, then to the dark (black) state. (see FIGURE1 shown in Appendix) Luminance Contrast Ratio (CR) is defined mathematically as $CR = \text{Luminance when displaying a white raster} / \text{Luminance when displaying a black raster}$.
3. Average Luminance of White is defined as arithmetic mean of five measurement points across the LCD surface. Luminance shall be measured with all pixels in the view field set to white. This measurement shall be taken at the locations shown in FIGURE 2 for a total of the measurements per display.
The Average Luminance of White is varied by the Back-light Current, IBL.
4. The White Luminance Uniformity on LCD surface is then expressed as : $\Delta Y = \text{Maximum Luminance of nine points} / \text{Minimum Luminance of nine points}$ (see FIGURE 3)
5. The Color Chromaticity Coordinates specified in Table 4. shall be calculated from the spectral data measured with all pixels, red, green, blue and white. Measurements shall be made at the center of the panel.
6. The Electro-optical Response Time measurements shall be made as shown in FIGURE 4 (shown in Appendix) by switching the "data" input signal ON and OFF. The times needed for the luminance to change from 0% to 90% is Td, and 100% to 10% is Tr.
7. Cross-Talk of one area of the LCD surface by another shall be measured by comparing the luminance (Y_A) of a 25mm diameter area with all display pixels set to a gray level, to the luminance (Y_B) of the same area when center window area is driven dark (Refer to FIGURE 5).

SPEC. NUMBER S864-1015	SPEC. TITLE HT14X11-103 Product Specification for TFT-LCD	PAGE OF 8 / 21
---------------------------	---	-------------------

	PRODUCT GROUP	REV.	ISSUE DATE
	TFT-LCD PRODUCT	C	1999.10.11

5.0 INTERFACE CONNECTION.

5.1 Electrical Interface Connection

The electronics interface connector is a model FI-SEB20P-HF manufactured by JAE or equivalent. The mating connector part number is FI-S20S-HF or equivalent. The connector interface pin assignments are listed in Table 5.

<Table 5. Pin Assignment for the Interface Connector>

Terminal NO.	Symbol	Function
1	VDD1	Power Supply : +3.3V
2	VDD2	Power Supply : +3.3V
3	VSS1	Ground
4	VSS2	Ground
5	RIN0-	Transmission Data of 0 Negative -
6	RIN0+	Transmission Data of 0 Positive +
7	VSS3	Ground
8	RIN1-	Transmission Data of 1 Negative -
9	RIN1+	Transmission Data of 1 Positive +
10	VSS4	Ground
11	RIN2-	Transmission Data of 2 Negative -
12	RIN2+	Transmission Data of 2 Positive +
13	VSS5	Ground
14	CLK-	Sampling Clock of Negative -
15	CLK+	Sampling Clock of Positive +
16	VSS6	Ground
17	NC1	No Connection
18	NC2	No Connection
19	VSS7	Ground
20	VSS8	Ground

SPEC. NUMBER S864-1015	SPEC. TITLE HT14X11-103 Product Specification for TFT-LCD	PAGE OF 9 / 21
---------------------------	---	-------------------

	PRODUCT GROUP	REV.	ISSUE DATE
	TFT-LCD PRODUCT	C	1999.10.11

5.2 Back-light Interface

The Back-light interface connector is a model BHSR-02VS-1 manufactured by JST or equivalent. The connector interface pin assignments are listed in Table 6.

<Table 6. Back-light Electrical Interface>

Terminal No.	Symbol	Function
1	VL	CCFL Power Supply(High Voltage)
2	GL	CCFL Power Supply(GND Side)

6.0 SIGNAL TIMING SPECIFICATIONS

The specification of the signal timing parameter is listed in Table 7.

<Table 7. Signal Timing Specifications>

ITEM	Symbol	Min.	Typ.	Max.	Unit	Remarks
Frame Period	t1	801 x t3	806 x t3 16.67	812 x t3	-- ms	60Hz
Vertical Display Period	t2	768 x t3	768 x t3 15.88	768 x t3	-- ms	
One Line Scanning Period	t3	1152 x t5	1344 x t5 20.67	1364 x t5	-- us	48.38KHz
Horizontal Display Period	t4	1024 x t5	1024 x t5 15.75	1024 x t5	-- us	
Clock Time	t5		15.38		ns	65MHz
Clock "L" Time	t6	(5.0)	-	-	ns	
Clock "H" Time	t7	(5.0)	-	-	ns	
Set up Time	t8	5.0	-	-	ns	
Hold Time	t9	5.0	-	-	ns	

SPEC. NUMBER S864-1015	SPEC. TITLE HT14X11-103 Product Specification for TFT-LCD	PAGE OF 10 / 21
---------------------------	---	--------------------

7.0 SIGNAL TIMING WAVEFORMS

7.1 Vertical Timing Waveforms

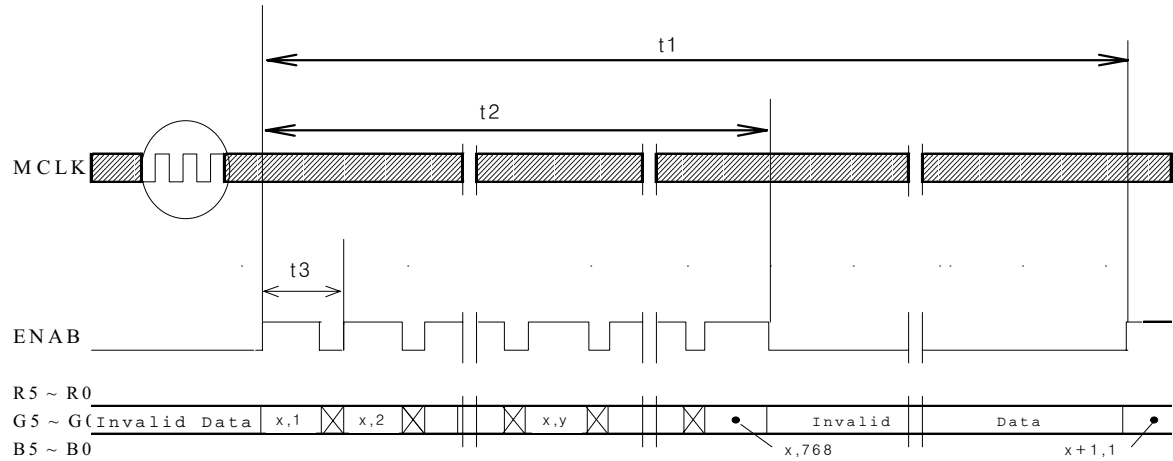

7.2 Horizontal Timing Waveforms

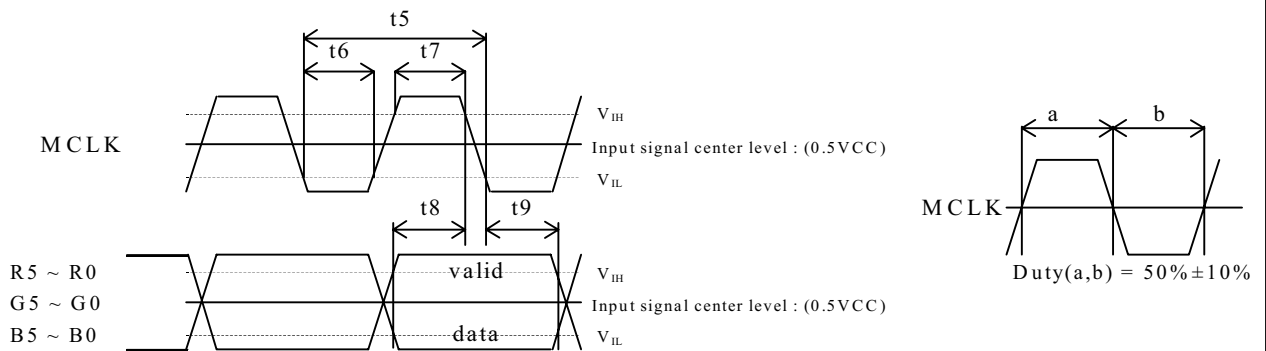
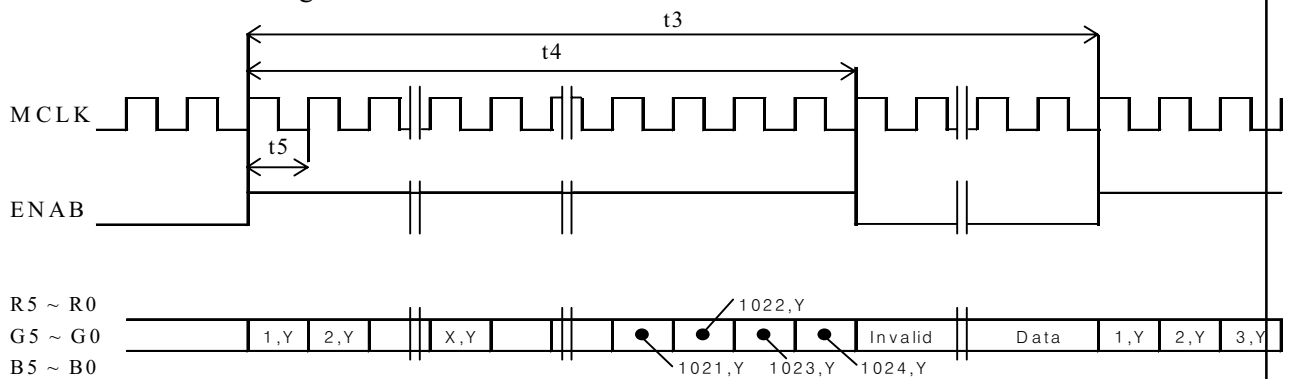

	PRODUCT GROUP	REV.	ISSUE DATE
	TFT-LCD PRODUCT	C	1999.10.11

8.0 INPUT SIGNALS, BASIC DISPLAY COLORS & GRAY SCALE OF COLORS

Each color is displayed in sixty-four gray scales from a 6 bits data signal input. A total of 262,144 colors are derived from the resultant 18 bits data. Table 8. shows the input signals, basic display colors and gray scale for each color.

<Table 8. Input signals, Basic display colors and Gray scale for each color.>

	Colors & Gray scale	Data signal																	
		R0	R1	R2	R3	R4	R5	G0	G1	G2	G3	G4	G5	B0	B1	B2	B3	B4	B5
Basic colors	Black	0	0	0	0	0	0	0	0	0	0	0	0	0	0	0	0	0	0
	Blue	0	0	0	0	0	0	0	0	0	0	0	0	1	1	1	1	1	1
	Green	0	0	0	0	0	0	1	1	1	1	1	1	0	0	0	0	0	0
	Light Blue	0	0	0	0	0	0	1	1	1	1	1	1	1	1	1	1	1	1
	Red	1	1	1	1	1	1	0	0	0	0	0	0	0	0	0	0	0	0
	Purple	1	1	1	1	1	1	0	0	0	0	0	0	1	1	1	1	1	1
	Yellow	1	1	1	1	1	1	1	1	1	1	1	1	0	0	0	0	0	0
	White	1	1	1	1	1	1	1	1	1	1	1	1	1	1	1	1	1	1
Gray scale of Red	Black	0	0	0	0	0	0	0	0	0	0	0	0	0	0	0	0	0	0
	△	1	0	0	0	0	0	0	0	0	0	0	0	0	0	0	0	0	0
	Darker	0	1	0	0	0	0	0	0	0	0	0	0	0	0	0	0	0	0
	△																		
	▽																		
	Brighter	1	0	1	1	1	1	0	0	0	0	0	0	0	0	0	0	0	0
▽	0	1	1	1	1	1	0	0	0	0	0	0	0	0	0	0	0	0	
Red	1	1	1	1	1	1	0	0	0	0	0	0	0	0	0	0	0	0	
Gray scale of Green	Black	0	0	0	0	0	0	0	0	0	0	0	0	0	0	0	0	0	0
	△	0	0	0	0	0	0	1	0	0	0	0	0	0	0	0	0	0	0
	Darker	0	0	0	0	0	0	0	1	0	0	0	0	0	0	0	0	0	0
	△																		
	▽																		
	Brighter	0	0	0	0	0	0	1	0	1	1	1	1	0	0	0	0	0	0
▽	0	0	0	0	0	0	0	1	1	1	1	1	0	0	0	0	0	0	
Green	0	0	0	0	0	0	1	1	1	1	1	1	0	0	0	0	0	0	
Gray scale of Blue	Black	0	0	0	0	0	0	0	0	0	0	0	0	0	0	0	0	0	0
	△	0	0	0	0	0	0	0	0	0	0	0	0	1	0	0	0	0	0
	Darker	0	0	0	0	0	0	0	0	0	0	0	0	0	1	0	0	0	0
	△																		
	▽																		
	Brighter	0	0	0	0	0	0	0	0	0	0	0	0	1	0	1	1	1	1
▽	0	0	0	0	0	0	0	0	0	0	0	0	0	1	1	1	1	1	
Blue	0	0	0	0	0	0	0	0	0	0	0	0	1	1	1	1	1	1	
Gray scale of White & Black	Black	0	0	0	0	0	0	0	0	0	0	0	0	0	0	0	0	0	0
	△	1	0	0	0	0	0	1	0	0	0	0	0	1	0	0	0	0	0
	Darker	0	1	0	0	0	0	0	1	0	0	0	0	0	1	0	0	0	0
	△																		
	▽																		
	Brighter	1	0	1	1	1	1	1	0	1	1	1	1	1	0	1	1	1	1
▽	0	1	1	1	1	1	0	1	1	1	1	1	0	1	1	1	1	1	
White	1	1	1	1	1	1	1	1	1	1	1	1	1	1	1	1	1	1	

SPEC. NUMBER S864-1015	SPEC. TITLE HT14X11-103 Product Specification for TFT-LCD	PAGE OF 12 / 21
---------------------------	---	--------------------

9.0 POWER SEQUENCE

To prevent a latch-up or DC operation of the LCD module, the power on/off sequence shall be as shown in below.

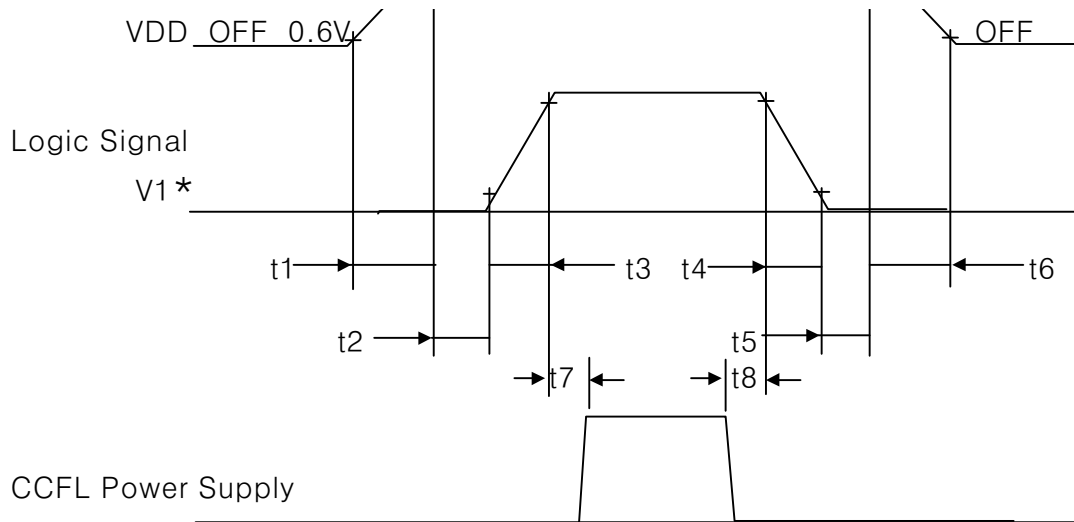

- $t1 \leq 10 \text{ ms}$
- $0 \leq t2 \leq 50 \text{ ms}$
- $0 \leq t3 \leq 50 \text{ ms}$
- $100 \text{ ms} \leq t7, t8 \leq 200 \text{ ms}$
- $0 \leq t4 \leq 50 \text{ ms}$
- $0 \leq t5 \leq 50 \text{ ms}$
- $t6 \leq 10 \text{ ms}$

* SET $0V \leq V1(t) \leq VDD(t)$

HERE, V1(t), VDD(t) indicate the transitive state of V1, VDD when the power supply is turned ON or OFF.

NOTE : Do not keep the interface signal high-impedance when power is on.

	PRODUCT GROUP	REV.	ISSUE DATE
	TFT-LCD PRODUCT	C	1999.10.11

10.0 MECHANICAL CHARACTERISTICS

10.1 Dimensional Requirements

FIGURE 6 and 7 (located in Appendix) show mechanical outlines for the model HT14X11-103. Other parameters are shown in Table 9.

<Table 9. Dimensional Parameters.>

Parameter	Specification	Unit
Active area	285.696(H) x 214.272(V)	mm
Number of pixels	1024(H) x 768(V)	pixels
	(1 pixel = R + G + B dot)	
Pixel pitch	0.279(H) x 0.279(V)	mm
Pixel arrangement	RGB Vertical stripe	
Display colors	262,144	colors
Display mode	Normally white	
Dimensional outline	300.5 ± 0.5 (H) x 227.0(V) ± 0.5 x 7.0(D) Typ.	mm
Weight	630 Typ.	g
Back-light	CCFL, Horizontal-lamp type	

10.2 Mounting

See FIGURE 6 and 7. (shown in Appendix)

10.3 Anti-Glare and Polarizer Hardness.

The surface of the LCD has an anti-glare coating to minimize reflection and a coating to reduce scratching.

10.4 Light Leakage

There shall not be visible light from the back-lighting system in the viewing angle around the edges of the screen as seen from a distance 50cm from the screen with an overhead light level of 350lux.

SPEC. NUMBER S864-1015	SPEC. TITLE HT14X11-103 Product Specification for TFT-LCD	PAGE OF 14 / 21
---------------------------	---	--------------------

	PRODUCT GROUP	REV.	ISSUE DATE
	TFT-LCD PRODUCT	C	1999.10.11

11.0 RELIABILITY TEST

The Reliability test items and its conditions are shown in below.

<Table 10. Reliability test>

No	Test Items	Conditions
1	High temperature storage test	Ta = 60 °C, 240 hrs
2	Low temperature storage test	Ta = -20 °C, 240 hrs
3	High temperature & high humidity operation test	Ta = 50 °C, 80 %RH, 240 hrs
4	High temperature operation test	Ta = 50 °C, 240 hrs
5	Low temperature operation test	Ta = 0 °C, 240 hrs
6	Thermal shock	Ta = -20 °C ↔ 60 °C (0.5 hr), 100 cycle
7	Vibration test (non-operating)	Frequency : 10 ~ 500 Hz Gravity/AMP : 1.5G X,Y,Z Period : 15 min
8	Shock test (non-operating)	Gravity : 70G Pulse width : 11 ms, half sine wave Direction : ±X, ±Y, ±Z once for each direction
9	Electrostatic discharge test	Air : 150 pF, 330Ω, 15 KV Contact : 150 pF, 330Ω, 8 KV

SPEC. NUMBER S864-1015	SPEC. TITLE HT14X11-103 Product Specification for TFT-LCD	PAGE OF 15 / 21
---------------------------	---	--------------------

	PRODUCT GROUP	REV.	ISSUE DATE
	TFT-LCD PRODUCT	C	1999.10.11

12.0 HANDLING & CAUTIONS

- (1) Cautions when taking out the module
 - Pick the pouch only, when taking out module from a shipping package.

- (2) Cautions for handling the module
 - As the electrostatic discharges may break the LCD module, handle the LCD module with care. Peel a protection sheet off from the LCD panel surface as slowly as possible.
 - As the LCD panel and back - light element are made from fragile glass material, impulse and pressure to the LCD module should be avoided.
 - As the surface of the polarizer is very soft and easily scratched, use a soft dry cloth without chemicals for cleaning.
 - Do not pull the interface connector in or out while the LCD module is operating.
 - Put the module display side down on a flat horizontal plane.
 - Handle connectors and cables with care.

- (3) Cautions for the operation
 - When the module is operating, do not lose CLK, ENAB signals. If any one of these signals is lost, the LCD panel would be damaged.
 - Obey the supply voltage sequence. If wrong sequence is applied, the module would be damaged.

- (4) Cautions for the atmosphere
 - Dew drop atmosphere should be avoided.
 - Do not store and/or operate the LCD module in a high temperature and/or humidity atmosphere. Storage in an electro-conductive polymer packing pouch and under relatively low temperature atmosphere is recommended.

- (5) Cautions for the module characteristics
 - Do not apply fixed pattern data signal to the LCD module at product aging.
 - Applying fixed pattern for a long time may cause image sticking.

- (6) Other cautions
 - Do not disassemble and/or re-assemble LCD module.
 - Do not re-adjust variable resistor or switch etc.
 - When returning the module for repair or etc, please pack the module not to be broken. We recommend to use the original shipping packages.

SPEC. NUMBER S864-1015	SPEC. TITLE HT14X11-103 Product Specification for TFT-LCD	PAGE OF 16 / 21
---------------------------	---	--------------------

13.0 APPENDIX

Figure 1. Measurement Set Up

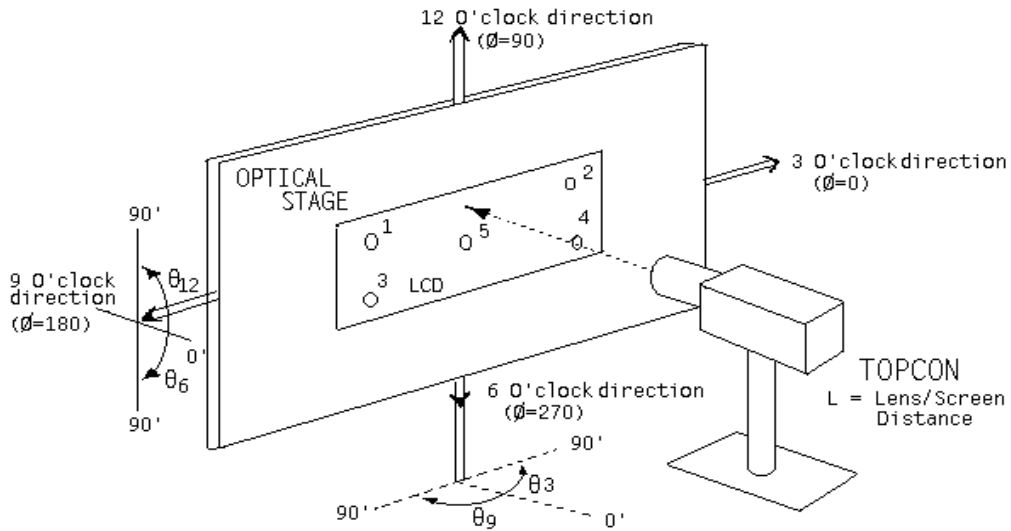

Figure 2. Average Luminance Measurement Locations

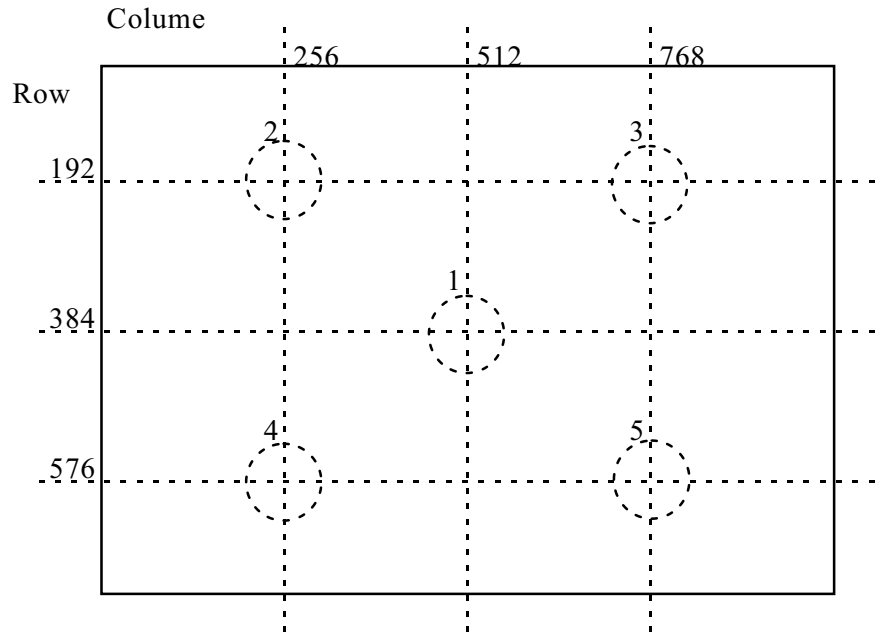

Figure 3. Uniformity Measurement Locations

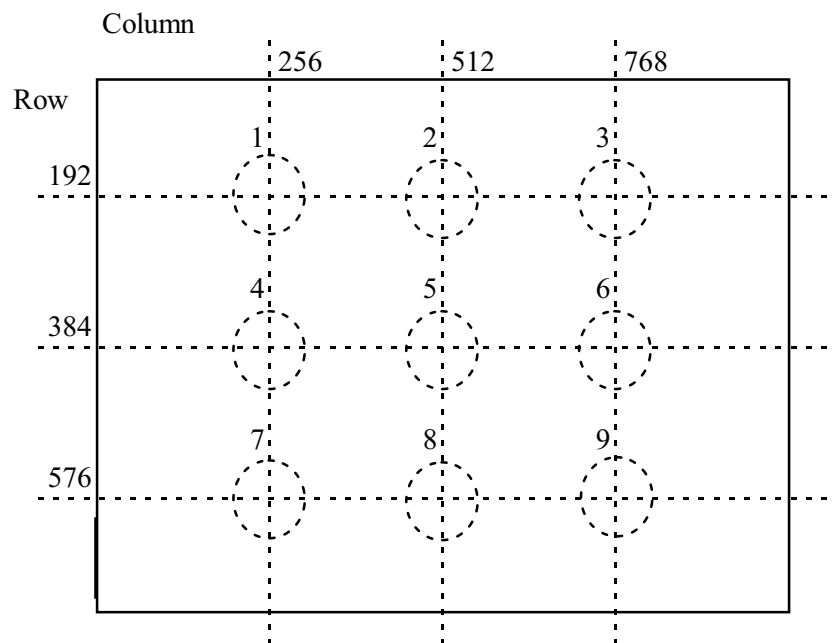

Figure 4. Response Time Testing

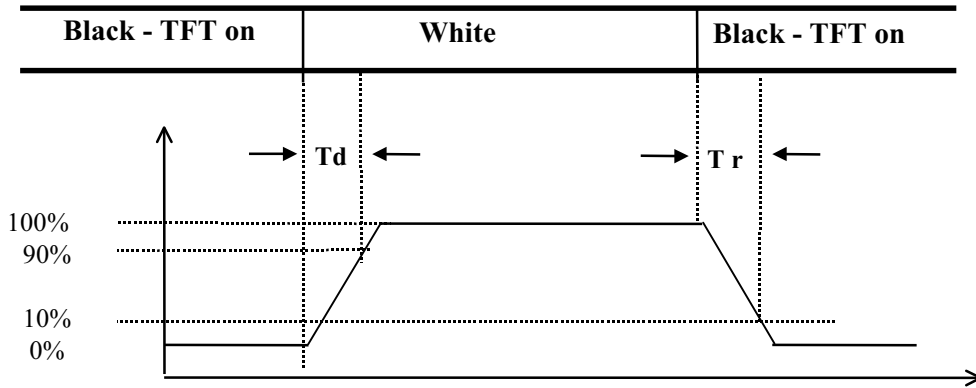

Figure 5. Cross Modulation Test Description



$$\text{Cross-Talk (\%)} = \left| \frac{Y_B - Y_A}{Y_B} \right| \times 100$$

Where:

Y_A = Initial luminance of measured area (cd/m^2)

Y_B = Subsequent luminance of measured area (cd/m^2)

The location measured will be exactly the same in both patterns

Figure 6. TFT-LCD Module Outline Dimensions (Front view)

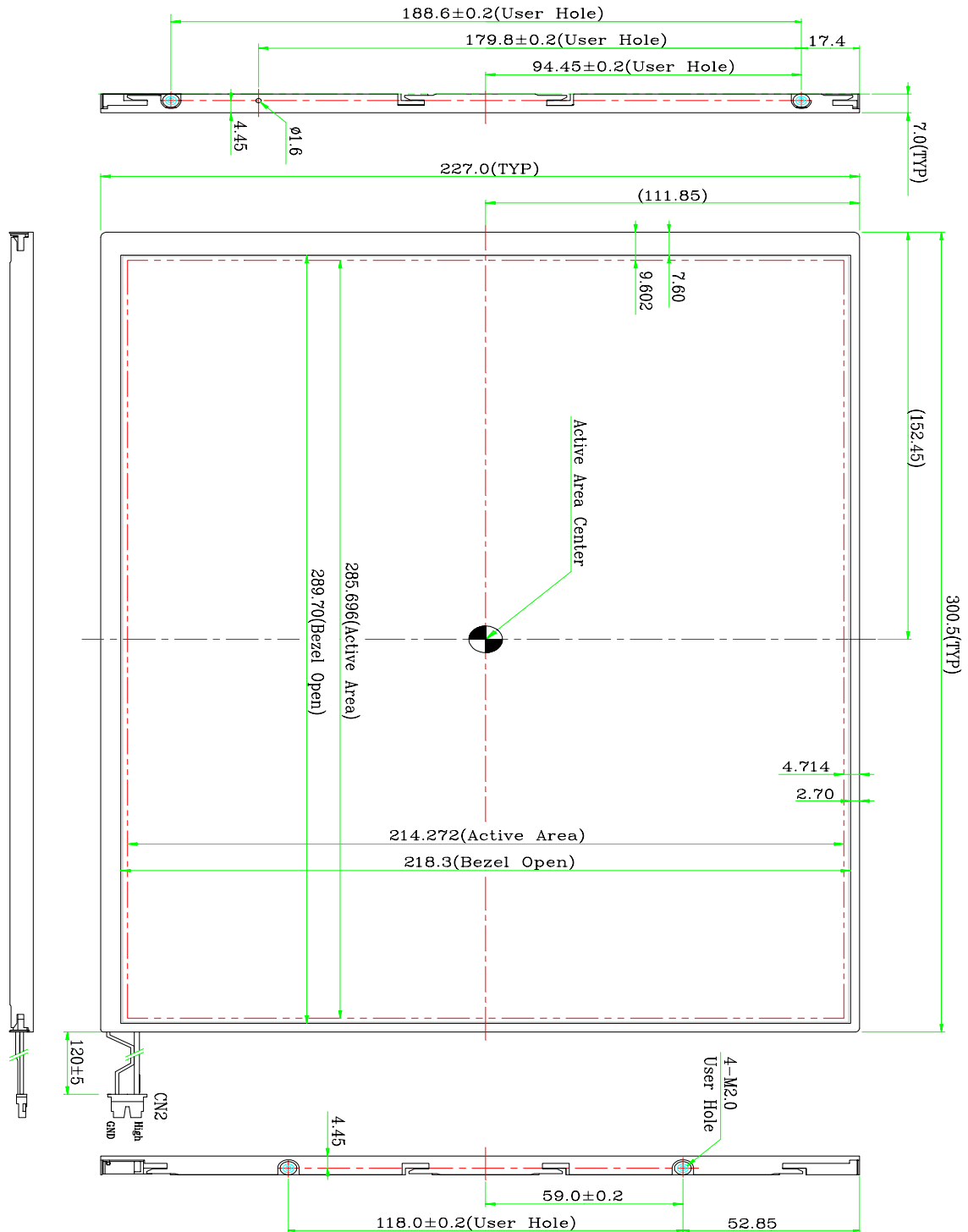
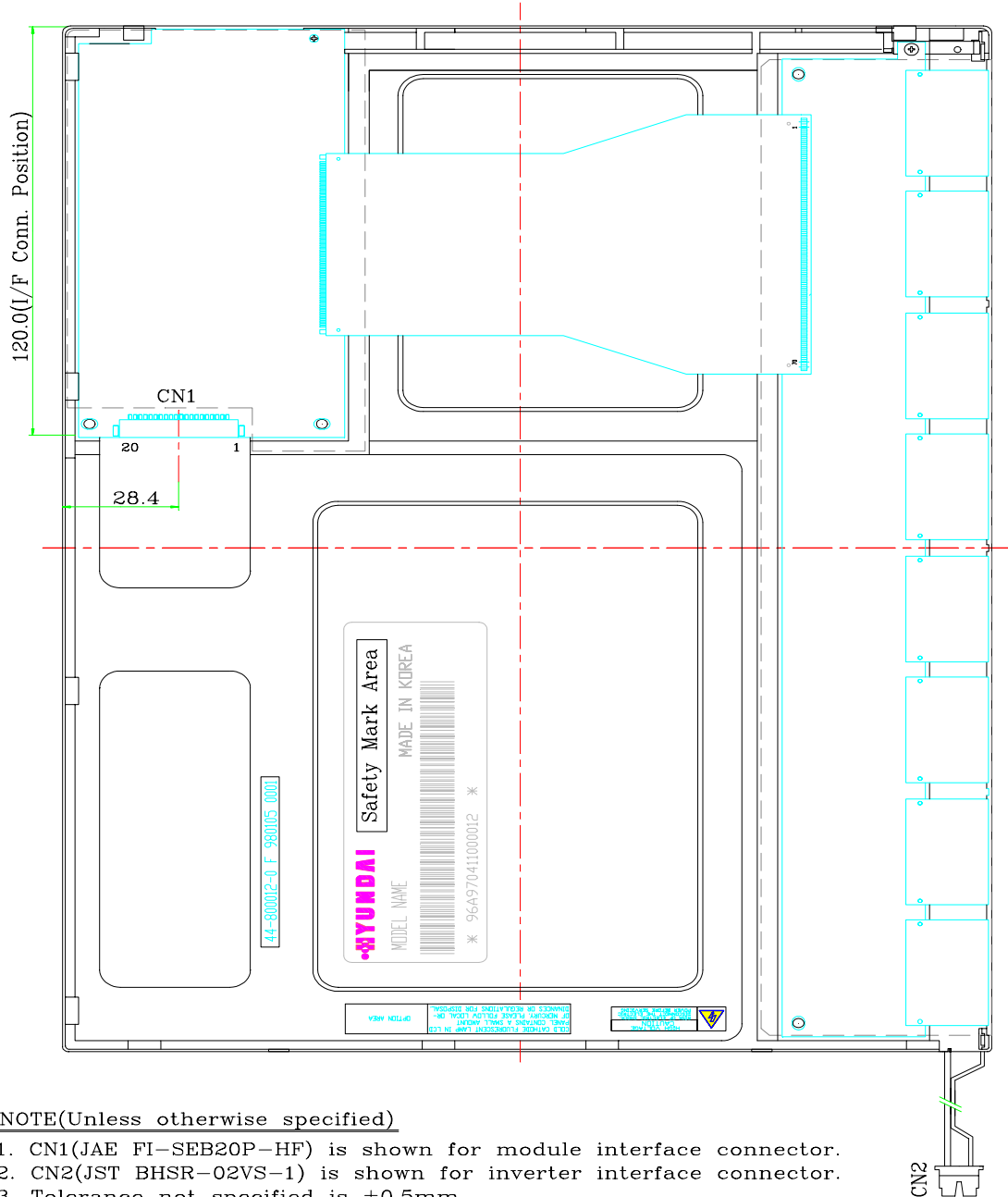

Figure 7. TFT-LCD Module Outline Dimensions (Rear view)



NOTE(Unless otherwise specified)

1. CN1(JAE FI-SEB20P-HF) is shown for module interface connector.
2. CN2(JST BHSR-02VS-1) is shown for inverter interface connector.
3. Tolerance not specified is $\pm 0.5\text{mm}$
4. Unit : mm