

FEATURES

- Double Side Cooling
- High Surge Capability

APPLICATIONS

- High Power Drives
- High Voltage Power Supplies
- Static Switches

VOLTAGE RATINGS

Part and Ordering Number	Repetitive Peak Voltages V_{DRM} and V_{RRM} V	Conditions
DCR950D14	1400	$T_{vj} = -40^{\circ}\text{C}$ to 125°C , $I_{DRM} = I_{RRM} = 50\text{mA}$, $V_{DRM}, V_{RRM} t_p = 10\text{ms}$, $V_{DSM} \& V_{RSM} =$ $V_{DRM} \& V_{RRM} + 100\text{V}$ respectively
DCR950D12	1200	
DCR950D10	1000	
DCR950D08	800	
DCR950D06	600	

Lower voltage grades available.

KEY PARAMETERS

V_{DRM}	1400 V
$I_{T(AV)}$	950 A
I_{TSM}	12800 A
dV/dt^*	1000 V/ μs
dI/dt	200 A/ μs

* Higher dV/dt selections available

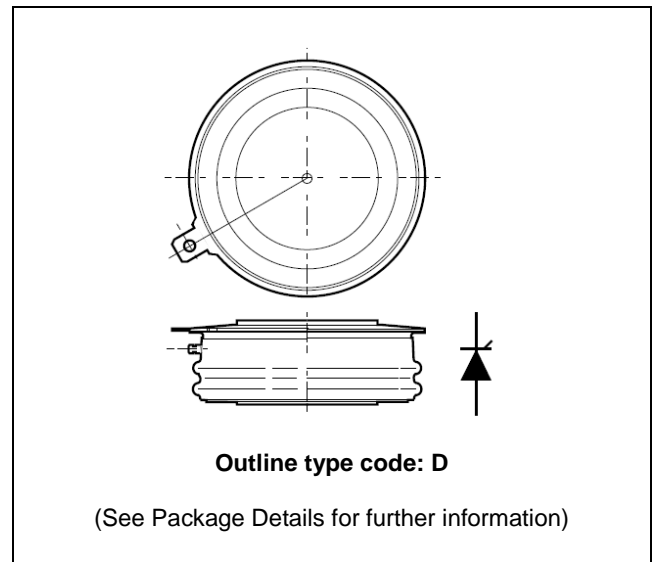

Fig. 1 Package outline

ORDERING INFORMATION

When ordering, select the required part number shown in the Voltage Ratings selection table.

For example:

DCR950D14

Note: Please use the complete part number when ordering and quote this number in any future correspondence relating to your order.

CURRENT RATINGS

T_{case} = 60°C unless stated otherwise

Symbol	Parameter	Test Conditions	Max.	Units
Double Side Cooled				
I _{T(AV)}	Mean on-state current	Half wave resistive load	950	A
I _{T(RMS)}	RMS value	-	1490	A
I _T	Continuous (direct) on-state current	-	1340	A

SURGE RATINGS

Symbol	Parameter	Test Conditions	Max.	Units
I _{TSM}	Surge (non-repetitive) on-state current	10ms half sine, T _{case} = 125°C	12.8	kA
I ² t	I ² t for fusing	V _R = 0	0.819	MA ² s

THERMAL AND MECHANICAL RATINGS

Symbol	Parameter	Test Conditions	Min.	Max.	Units
R _{th(j-c)}	Thermal resistance – junction to case	Double side cooled	-	0.035	°C/W
R _{th(c-h)}	Thermal resistance – case to heatsink	Double side cooled	-	0.01	°C/W
T _{vj}	Virtual junction temperature	Blocking V _{DRM} / V _{RRM}	-	125	°C
T _{stg}	Storage temperature range		-40	140	°C
F _m	Clamping force		8	12	kN

DYNAMIC CHARACTERISTICS

Symbol	Parameter	Test Conditions	Min.	Max.	Units	
I_{RRM}/I_{DRM}	Peak reverse and off-state current	At V_{RRM}/V_{DRM} , $T_{case} = 125^{\circ}C$	-	50	mA	
dV/dt	Max. linear rate of rise of off-state voltage	To 67% V_{DRM} , $T_j = 125^{\circ}C$, gate open	1000	-	V/ μs	
di/dt	Rate of rise of on-state current	From 67% V_{DRM} to 1000A Gate source 30V, 10 Ω , $t_r < 0.5\mu s$, $T_j = 125^{\circ}C$	Repetitive 50Hz	-	200	A/ μs
			Non-repetitive	-	1000	A/ μs
V_T	On-state voltage	$I_T = 1500A$, $T_{case} = 125^{\circ}C$		1.45	V	
$V_{T(TO)}$	Threshold voltage	$T_{case} = 125^{\circ}C$	-	0.87	V	
r_T	On-state slope resistance	$T_{case} = 125^{\circ}C$	-	0.382	m Ω	
t_{gd}	Delay time	$V_D = 67\% V_{DRM}$, gate source 30V, 10 Ω $t_r = 0.5\mu s$, $T_j = 25^{\circ}C$	-	3.0	μs	
t_q	Turn-off time	$T_j = 125^{\circ}C$, $V_R = 100V$, $di/dt = 10A/\mu s$, $dV_{DR}/dt = 20V/\mu s$ linear to 67% V_{DRM}	-	150	μs	
Q_S	Stored charge	$I_T = 1000A$, $t_p = 1000\mu s$, $T_j = 125^{\circ}C$, $di/dt = 10A/\mu s$,	-	1500	μC	
I_{RR}	Reverse recovery current		-	100	A	
I_L	Latching current	$T_j = 25^{\circ}C$,	-	1	A	
I_H	Holding current	$T_j = 25^{\circ}C$,	-	200	mA	

GATE TRIGGER CHARACTERISTICS AND RATINGS

Symbol	Parameter	Test Conditions	Max.	Units
V_{GT}	Gate trigger voltage	$V_{DRM} = 5V$, $T_{case} = 25^{\circ}C$	3	V
V_{GD}	Gate non-trigger voltage	At 40% V_{DRM} , $T_{case} = 125^{\circ}C$	TBD	V
I_{GT}	Gate trigger current	$V_{DRM} = 5V$, $T_{case} = 25^{\circ}C$	300	mA
I_{GD}	Gate non-trigger current	At 40% V_{DRM} , $T_{case} = 125^{\circ}C$	TBD	mA

CURVES

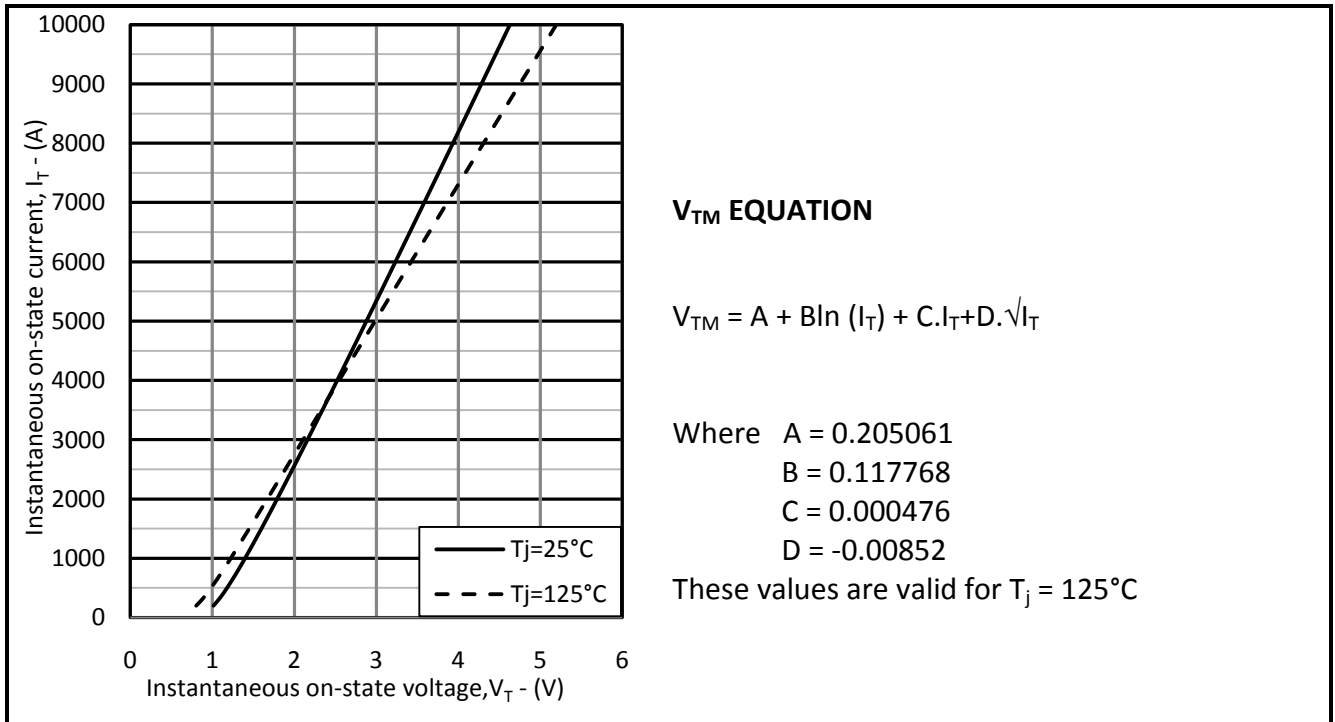

Fig.2 Maximum & minimum on-state characteristics

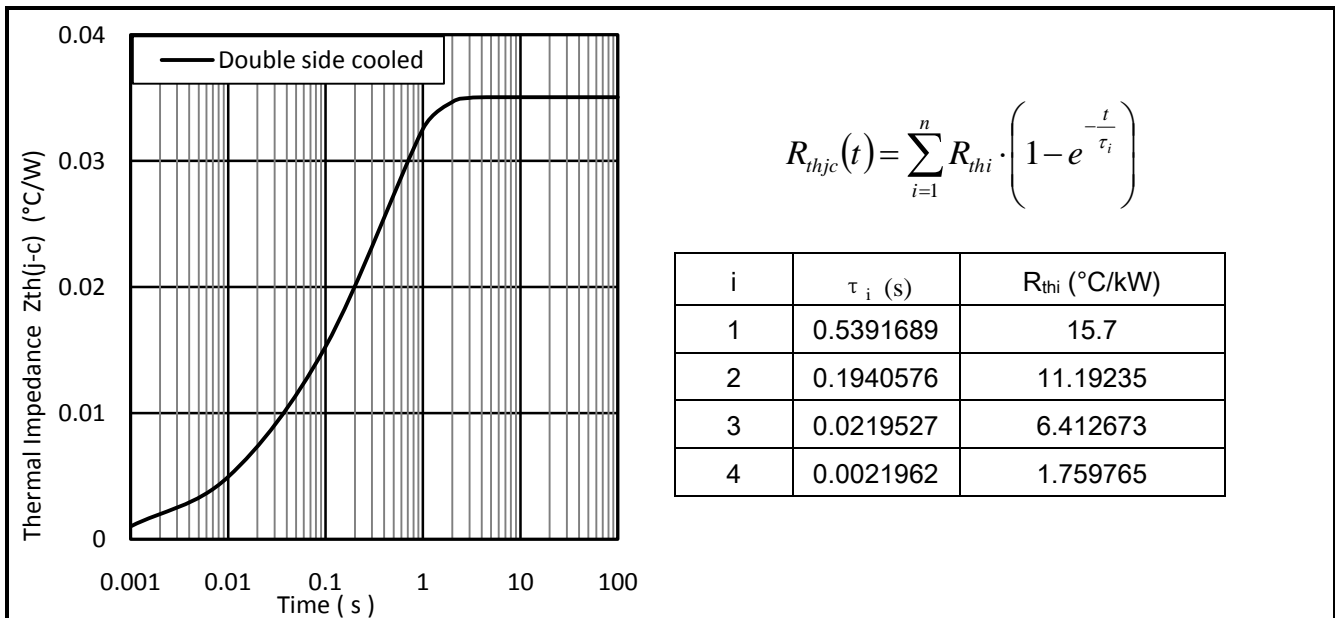

Fig.3 Maximum (limit) transient thermal impedance – junction to case (°C/W)

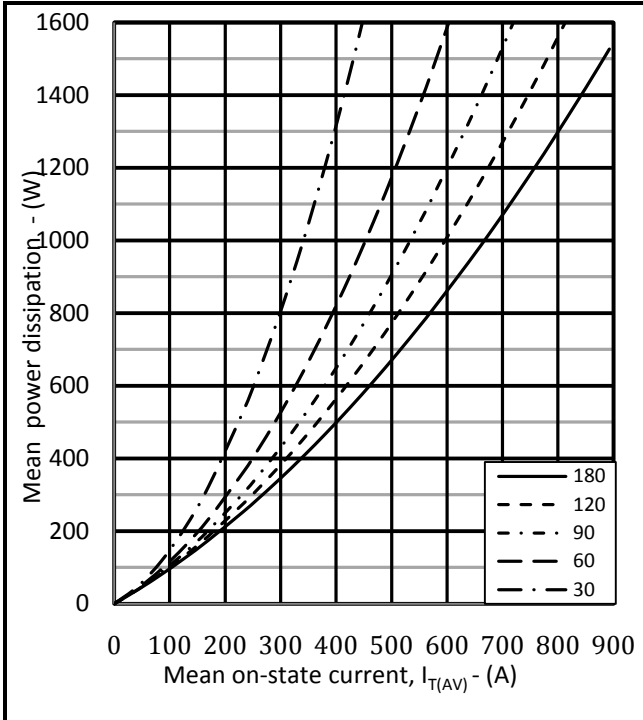

Fig.4 On-state power dissipation – sine wave

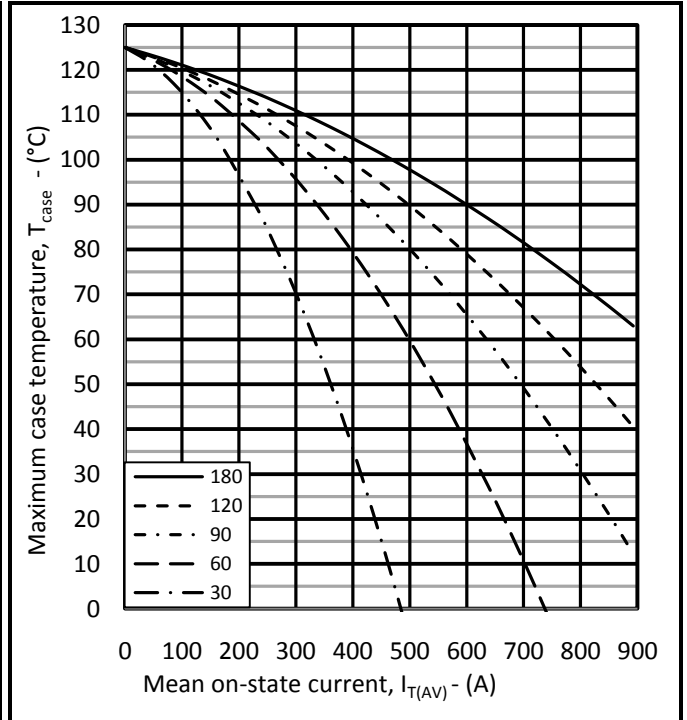

Fig.5 Maximum permissible case temperature, double side cooled – sine wave

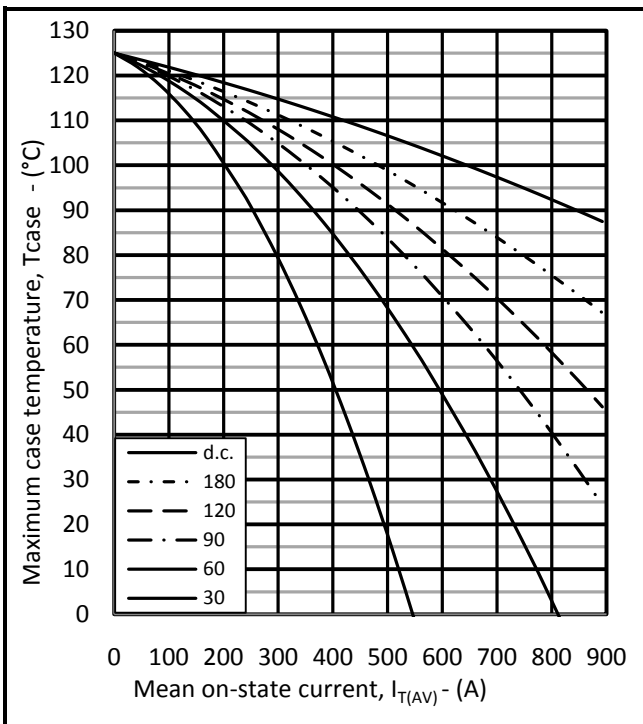

Fig.6 Maximum permissible case temperature, double side cooled – rectangular wave

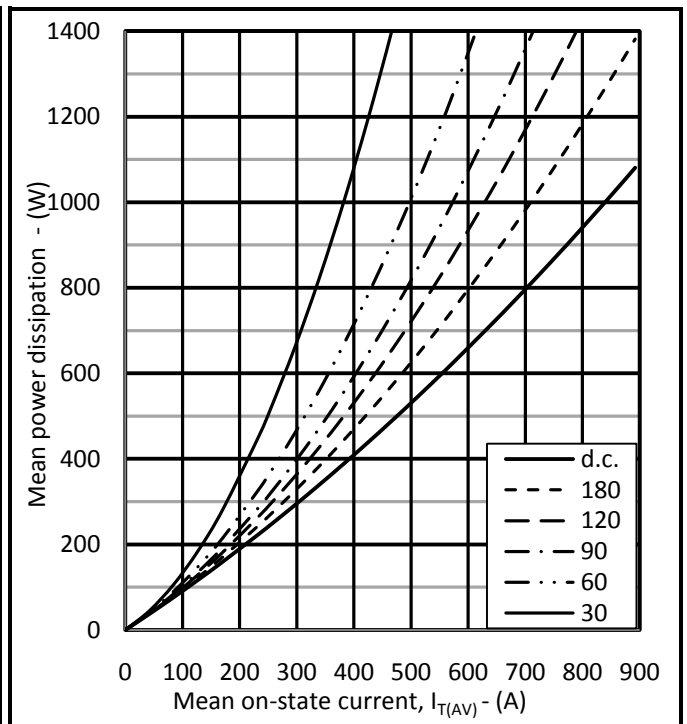

Fig.7 On-state power dissipation – rectangular wave

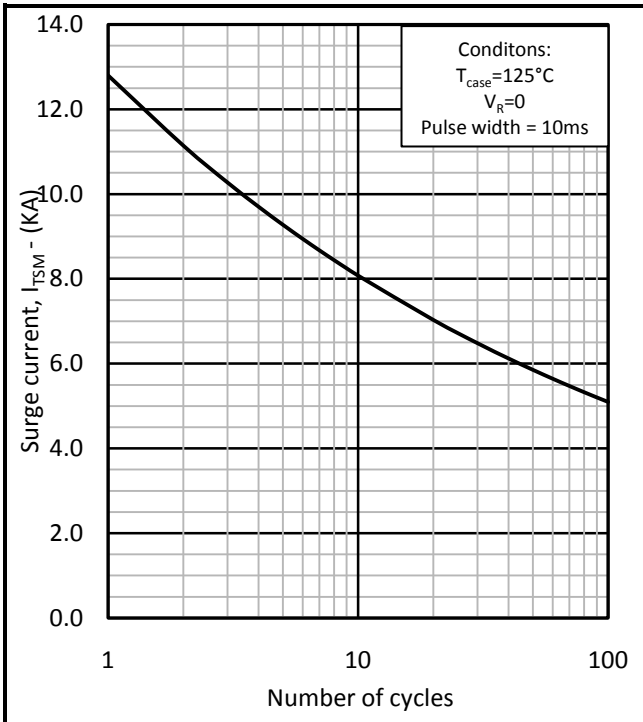

Fig.8 Multi-cycle surge current

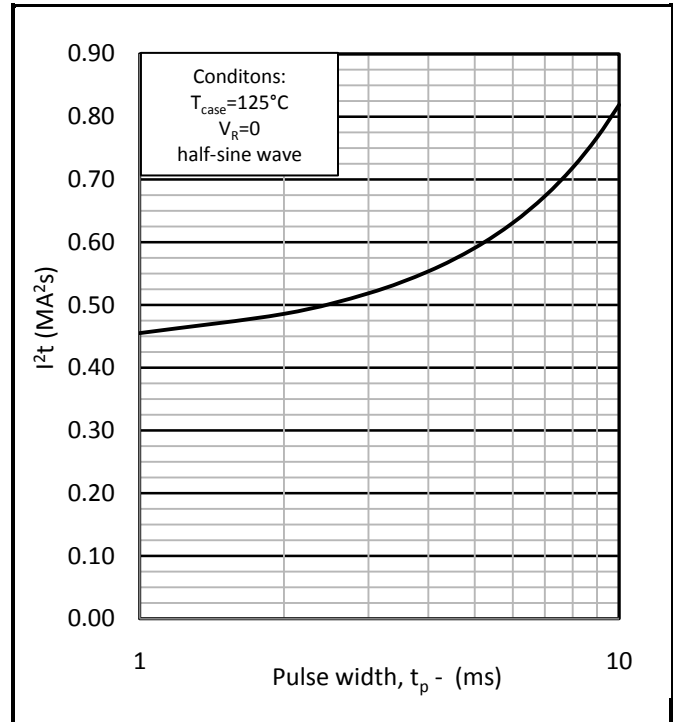

Fig.9 Single-cycle I^2t

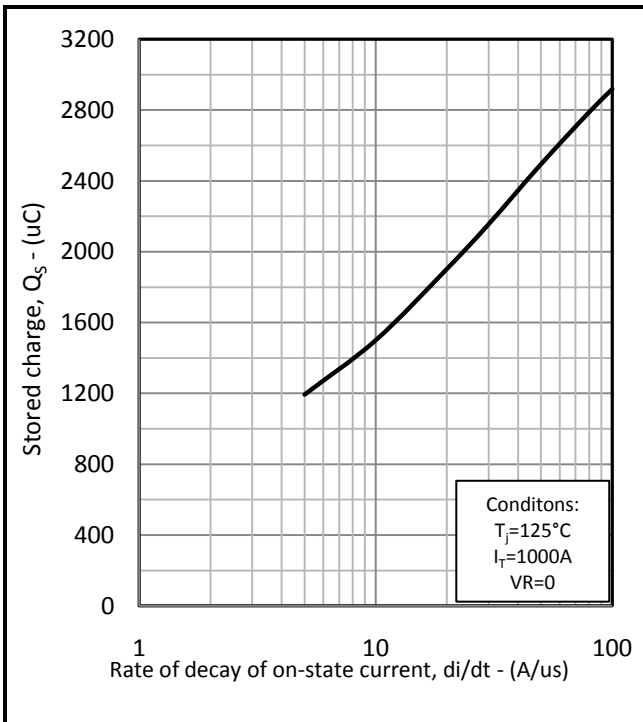

Fig.10 Stored charge vs di/dt

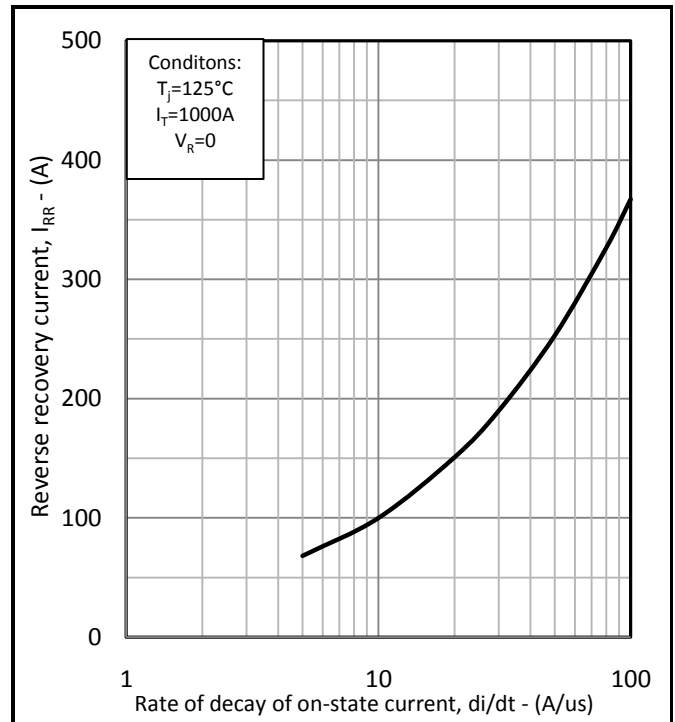

Fig.11 Reverse recovery current vs di/dt

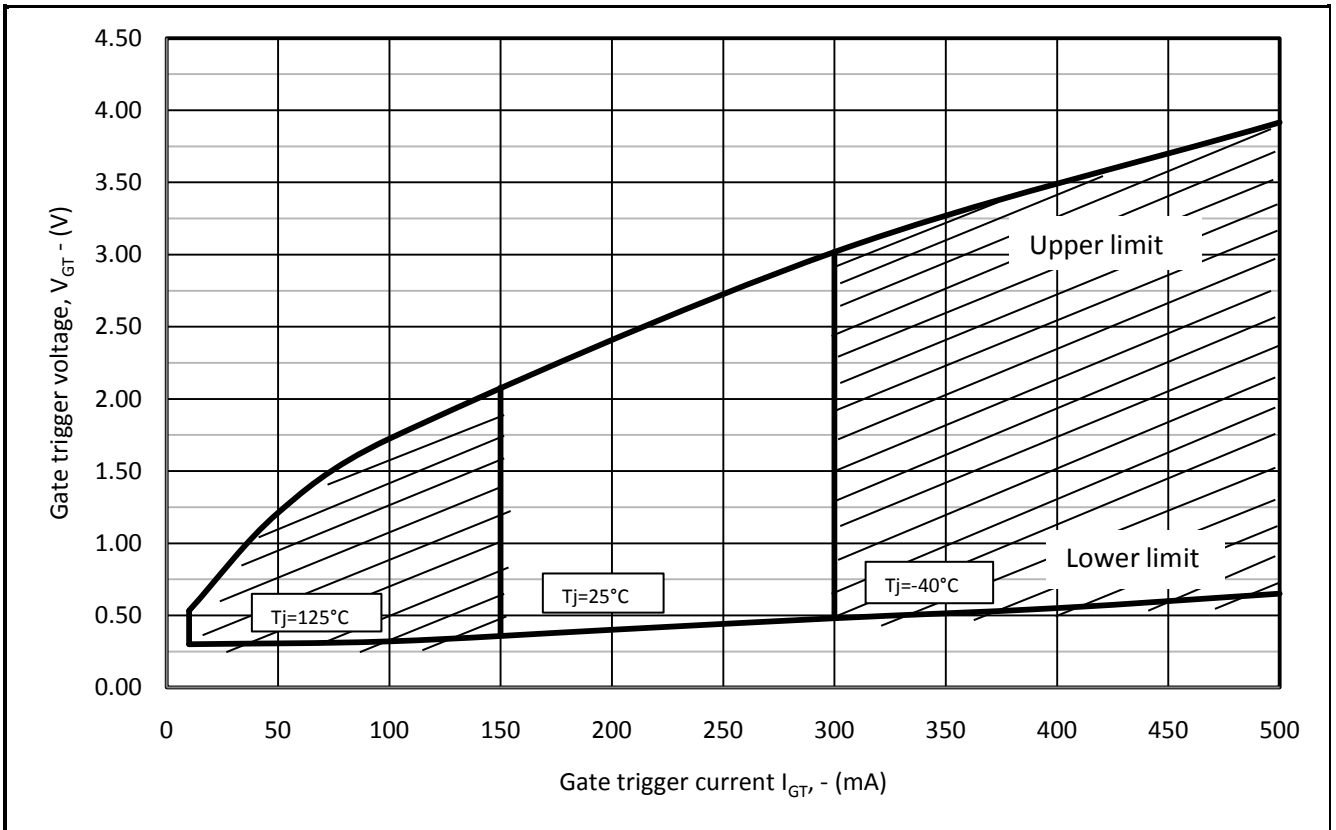
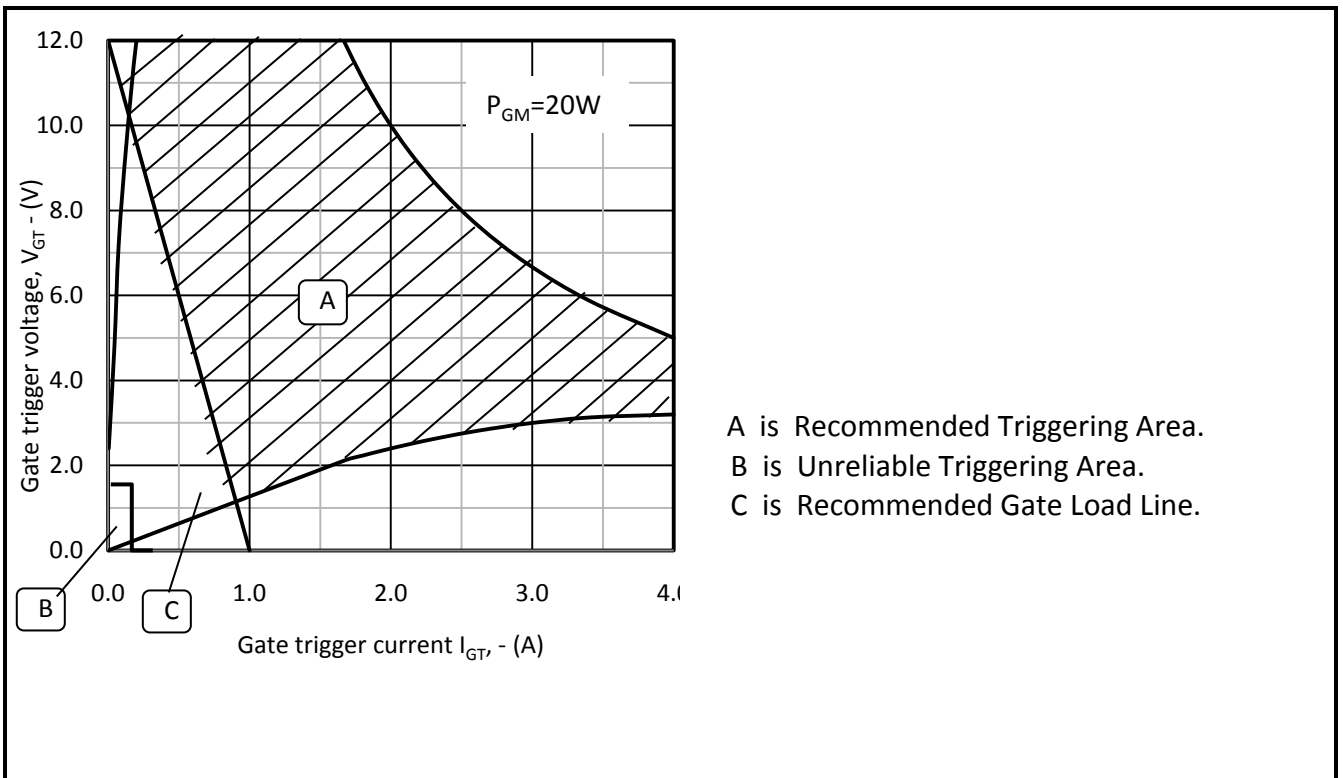

Fig.12 Gate characteristics



A is Recommended Triggering Area.
B is Unreliable Triggering Area.
C is Recommended Gate Load Line.

Fig.13 Gate characteristics

PACKAGE DETAILS

For further package information, please contact Customer Services. All dimensions in mm, unless stated otherwise. DO NOT SCALE.

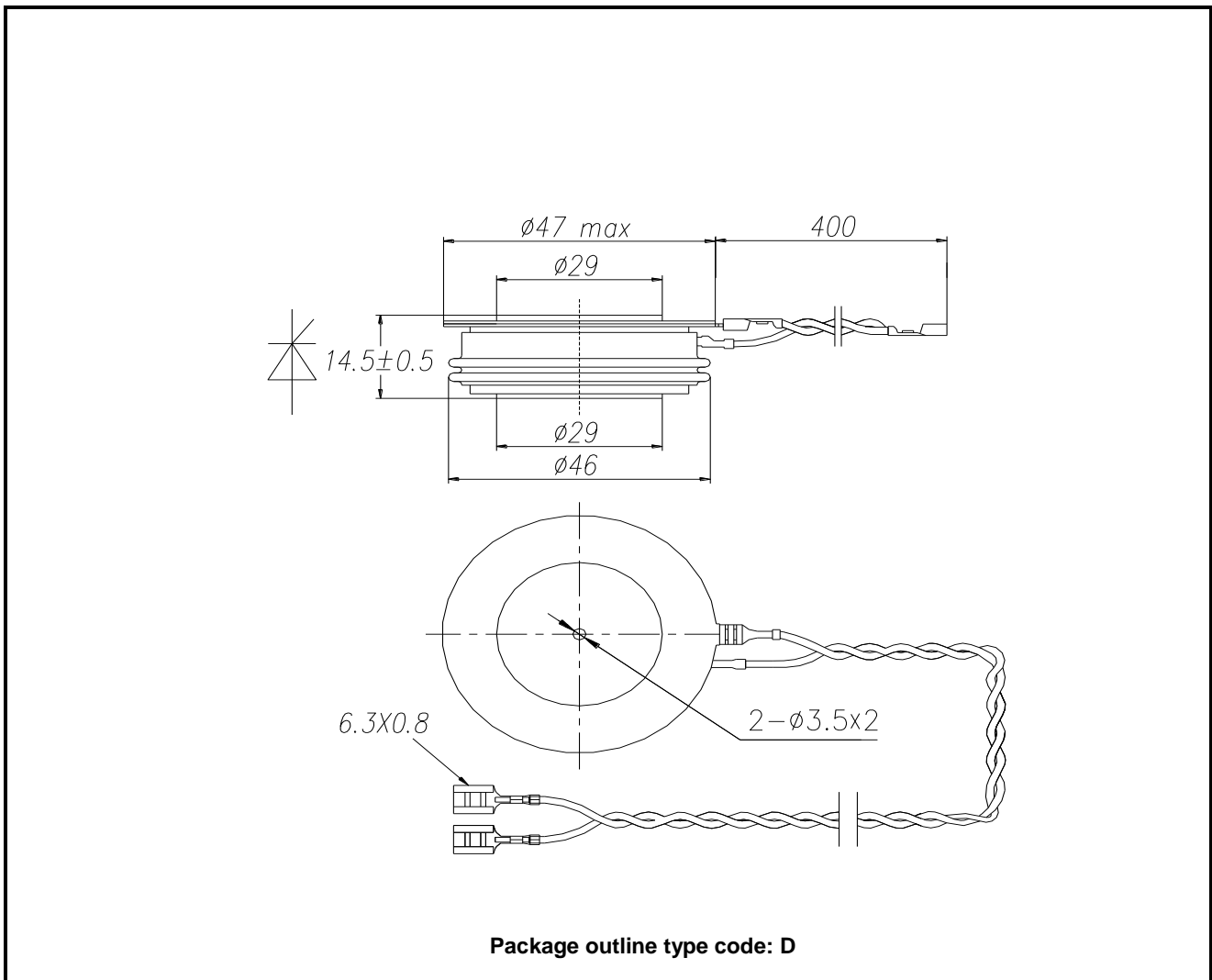

Fig.14 Package outline

IMPORTANT INFORMATION:

This publication is provided for information only and not for resale.

The products and information in this publication are intended for use by appropriately trained technical personnel.

Due to the diversity of product applications, the information contained herein is provided as a general guide only and does not constitute any guarantee of suitability for use in a specific application. The user must evaluate the suitability of the product and the completeness of the product data for the application. The user is responsible for product selection and ensuring all safety and any warning requirements are met. Should additional product information be needed please contact Customer Service.

Although we have endeavoured to carefully compile the information in this publication it may contain inaccuracies or typographical errors. The information is provided without any warranty or guarantee of any kind.

This publication is an uncontrolled document and is subject to change without notice. When referring to it please ensure that it is the most up to date version and has not been superseded.

The products are not intended for use in applications where a failure or malfunction may cause loss of life, injury or damage to property. The user must ensure that appropriate safety precautions are taken to prevent or mitigate the consequences of a product failure or malfunction.

The products must not be touched when operating because there is a danger of electrocution or severe burning. Always use protective safety equipment such as appropriate shields for the product and wear safety glasses. Even when disconnected any electric charge remaining in the product must be discharged and allowed to cool before safe handling using protective gloves.

Extended exposure to conditions outside the product ratings may affect reliability leading to premature product failure. Use outside the product ratings is likely to cause permanent damage to the product. In extreme conditions, as with all semiconductors, this may include potentially hazardous rupture, a large current to flow or high voltage arcing, resulting in fire or explosion. Appropriate application design and safety precautions should always be followed to protect persons and property.

Product Status & Product Ordering:

We annotate datasheets in the top right hand corner of the front page, to indicate product status if it is not yet fully approved for production. The annotations are as follows:-

Target Information:	This is the most tentative form of information and represents a very preliminary specification. No actual design work on the product has been started.
Preliminary Information:	The product design is complete and final characterisation for volume production is in progress. The datasheet represents the product as it is now understood but details may change.
No Annotation:	The product has been approved for production and unless otherwise notified by Dynex any product ordered will be supplied to the current version of the data sheet prevailing at the time of our order acknowledgement.

All products and materials are sold and services provided subject to Dynex's conditions of sale, which are available on request.

Any brand names and product names used in this publication are trademarks, registered trademarks or trade names of their respective owners.

HEADQUARTERS OPERATIONS

DYNEX SEMICONDUCTOR LIMITED
Doddington Road, Lincoln, Lincolnshire, LN6 3LF
United Kingdom.
Phone: +44 (0) 1522 500500
Fax: +44 (0) 1522 500550
Web: <http://www.dynexsemi.com>

CUSTOMER SERVICE

Phone: +44 (0) 1522 502753 / 502901
Fax: +44 (0) 1522 500020
e-mail: power_solutions@dynexsemi.com