



AN1523 APPLICATION NOTE

11W FLYBACK CONVERTER FOR AUXILIARY POWER SUPPLY APPLICATION USING THE L6590

by Claudio Spini

This document describes an 11W Switch Mode Power Supply reference design, dedicated to Consumer Applications, e.g. TV chassis auxiliary power supply, low cost Set-top box or digital equipment. The board accepts full range input voltage (90 to 265Vrms) and delivers 2 output voltages. It is based on the monolithic controller L6590, integrating the controller and a POWERMOS and working at fixed frequency, PWM mode and including a stand-by function to minimize the power consumption during light load operation. It incorporates also all the protections, offering a complete and very compact solution for low power SMPS.

Introduction

Low power SMPS are today very popular in consumer applications for example like low-cost cable, terrestrial decoders or high end TV chassis and the manufacturers need to design circuits with good performance, small size with high cost effectiveness. An integrated monolithic solution controlling the SMPS like the L6590 makes it a very suitable device, able to satisfy all the requirements of a compact and flexible solution, integrating all the necessary functions to obtain a robust design just adding few external components. In this proposed reference design, the board is thru-hole technology, without any heat sink. A specific application circuit fully tested is proposed and the test results, including thermal and EMI, are enclosed in this document. The transformer data are included too, making it a good way to achieve a very short time to market solution.

SMPS Main characteristics

● INPUT AND OUTPUT VOLTAGES:

INPUT VOLTAGE:		OUTPUT VOLTAGES AT FULL LOAD:			
		Vout	Iout	Pout	STABILITY
		[V]	[A]	[W]	
Vin:	90 ÷ 264 Vrms	5	1.4	7.5	±2%
f:	45÷ 66 Hz	12	0.3	3.6	±5%

$$P_{OUT} (W) = 11.1$$

● STAND BY:

During the stand-by operation the power consumption from the mains has to be $\leq 1W$, when the circuit delivers 50mA from the 5V output and the 12V is unloaded.

● PROTECTIONS:

Overload and short circuit on both outputs, with auto-restart at short removal. An OVP circuit for open-loop protection.

● SAFETY:

In acc. with EN60065, creepage and clearance minimum distance is 4.8mm

● EMI:

In acc. with EN50022 Class B

AN1523 APPLICATION NOTE

Electrical diagram

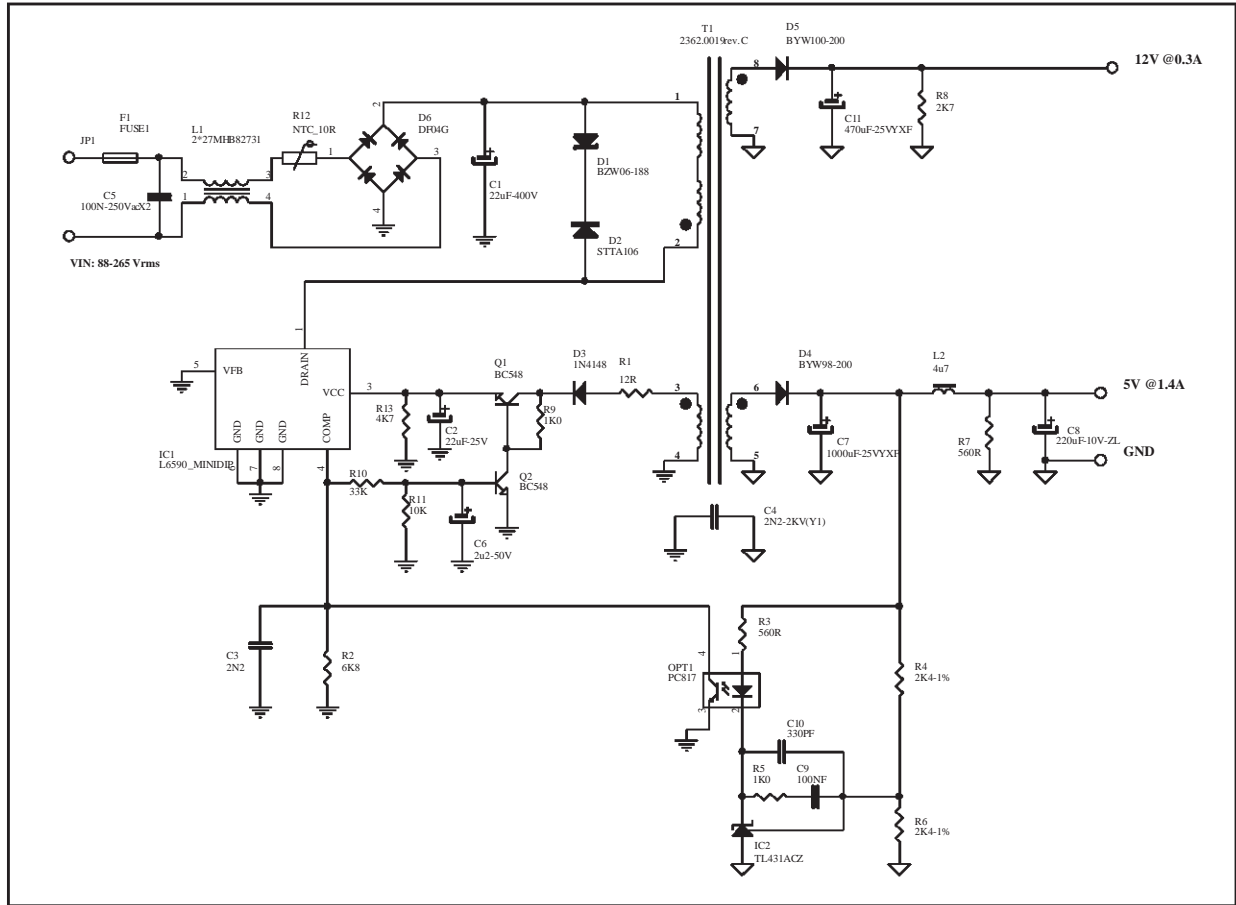

The SMPS topology is the standard Fly-back, working in continuous mode at low input voltage. Core of this SMPS is the L6590, a monolithic device integrating the controller and a 700V MOSFET, available in Minidip or SO-16 popular packages. In this design, the Minidip has been used. The switching frequency is fixed by an internal oscillator at 65KHz during normal operation. When a light load is detected, the oscillator switches automatically to 22KHz, thus increasing the stand-by performance of the circuit. At start-up, the L6590 is activated by an internal current source that draws current from the DC bus and charges the capacitor C2. Thanks to this circuit, the wake-up time is shorter than the conventional resistor solution and independent from the input mains voltage. The current source is internally disconnected after that the Vcc voltage has reached the VccON value, to prevent power dissipation during light load operation. During normal operation, the device is powered by the transformer, via the diode D3. The network Q1, Q2, C6, R9, R10, R11 improves the circuit performance during faults. The components C3 and R2 belong to the feedback loop. The power dissipation of the L6590 is ensured by a copper area on the bottom side of the printed circuit board.

The transformer is a layer type, using Triple Insulation Wire for the secondary windings, manufactured by EL-DOR in accordance with the EN60065. The transformer reflected voltage is ~105V and the ferrite core size is a small, standard E20. The Transil D1 and the diode D2 clamp the peak of the leakage inductance voltage spike at a safe level for the operation of the L6590, providing enough room for the leakage inductance voltage spike with still margin for reliability.

The output rectifiers have been chosen in accordance with the maximum reverse voltage and their power dissipation. Standard, low-cost, axial, fast recovery rectifiers have been selected in order to avoid transformer fractional number of turns and to obtain the output voltage values as close as possible to the nominal ones. Of course, using High-voltage Schottky rectifier the efficiency at full load would be higher but the cost and the output voltage precision would be adversely affected. A small LC filter has been added on the +5V in order to filter the high frequency ripple without increasing the output capacitors size.

The output voltage regulation is performed by the secondary feedback on the 5V output. The feedback network is the typical using a TL431 driving an optocoupler, in this case a PC817, and insuring the insulation required by the safety regulation between primary and secondary. The opto-transistor drives directly the COMP pin of the L6590 modulating the PWM internal block of the L6590. The stability of the 12V is guaranteed by the transformer coupling.

The input EMI filter is a classical LC-filter, 1-cell for differential and common mode noise. A NTC has been inserted in series with the bulk capacitor to prevent very high peak current at plug insertion, while a standard 5*20 fuse protects in case of catastrophic failures. The PCB type is single layer, FR-4, 2 oz (70µm) thickness. The L6590 power dissipation is ensured by a copper area of 4 cm² connected to primary return.

Here following some waveforms during the normal operation at full load are depicted:

Figure 1. Vds & Id @FULL LOAD

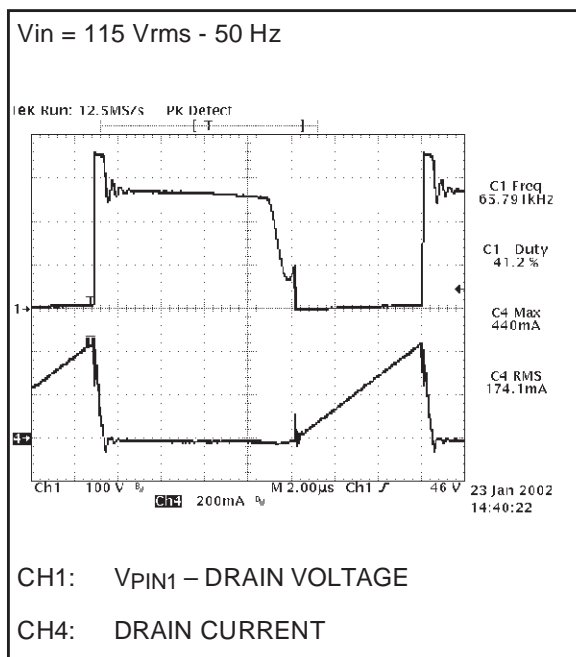
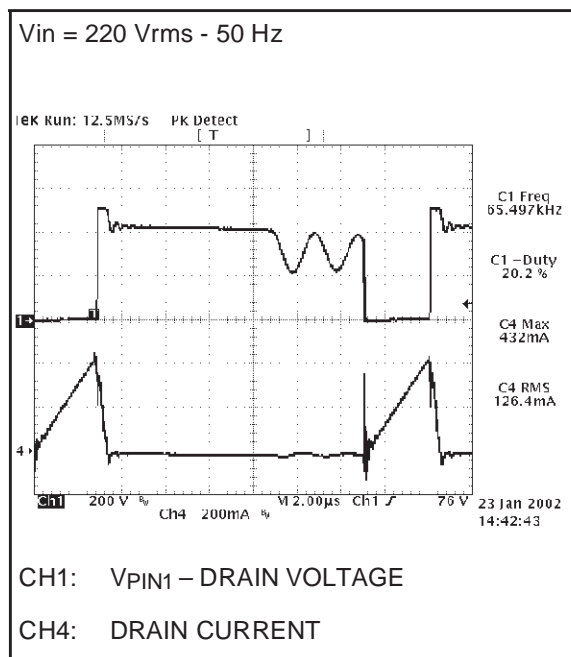

Figure 2. Vds & Id @FULL LOAD



The pictures of figure 1 and 2 show the drain voltage and current at the peak of the nominal input mains voltage during normal operation at full load. The circuit works in continuous mode for the effect of the voltage ripple across the input bulk capacitor at 115V while it goes in a depth discontinuous mode at 220V. Here are captured the trace at the peak of the input voltage sine wave.

Figure 3 gives the measurement of the drain peak voltage at full load and maximum input mains voltage. The voltage peak, which is 604V, guarantees a reliable operation of the L6590 thanks to a good margin against the maximum BVDSS of the device, which is 700V. Hence, a derating of 86% is achieved in the worst mains line condition. The maximum PIV of the diodes (on figure 4) has been measured during the worst operating condition at 265Vac and it is indicated on the right of each picture. The margin, with respect to the maximum voltage sustained by the diodes, assures a safe operating condition for the devices, contributing to obtain a high MTBF of the circuit, using the MIL-HDBK217 calculation method.

In figure 5 and 6 the most salient controller IC signals are represented. In both pictures, it is possible to distinguish clean waveforms free of hard spikes or noise that could affect the controller correct operation

Figure 3. Vds @FULL LOAD & Vin_{MAX}

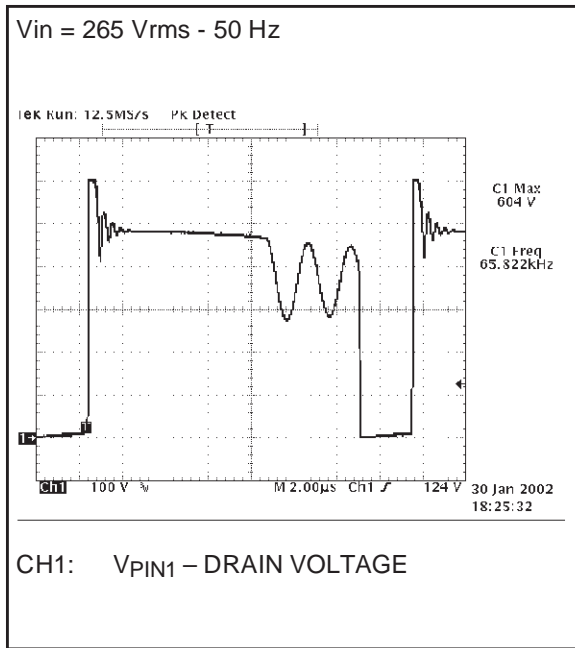

Figure 4. PIV @FULL LOAD & Vin_{MAX}

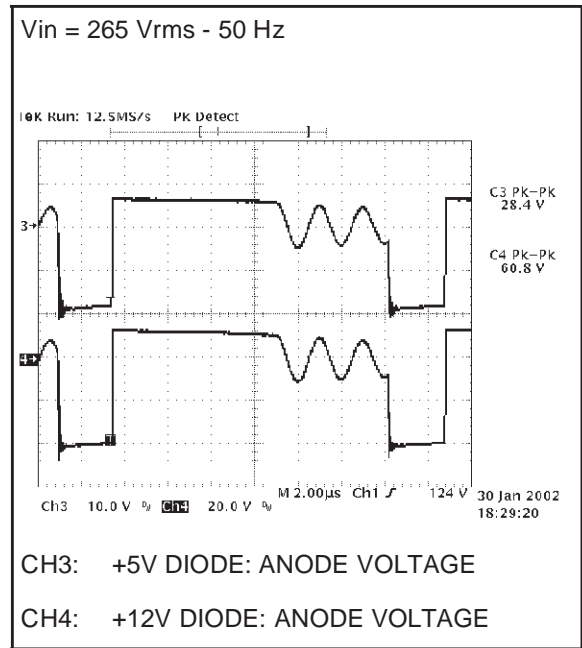

Figure 5. L6590 signals @FULL LOAD

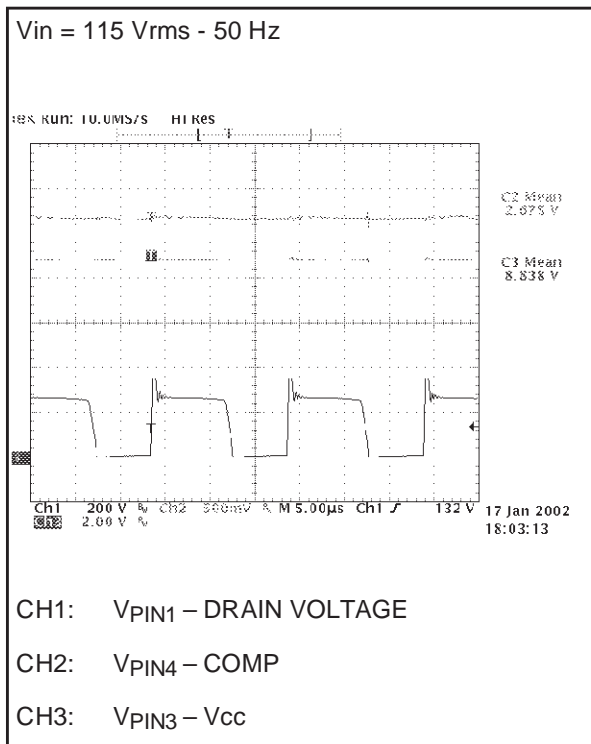
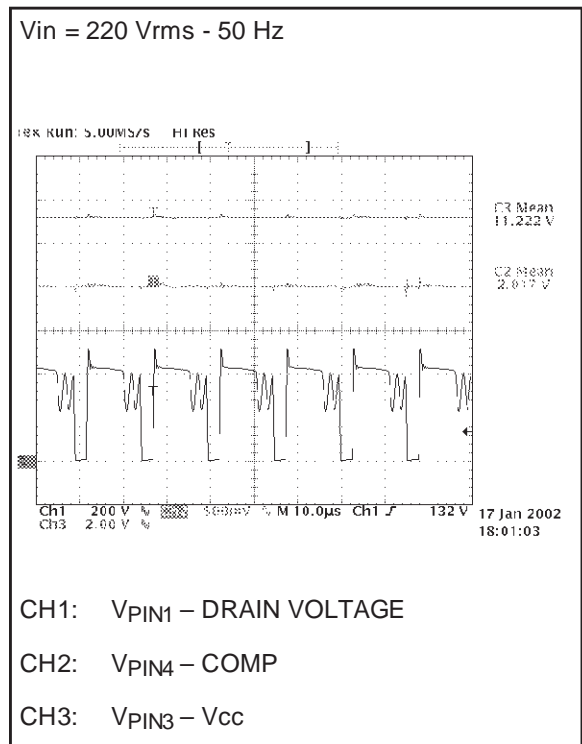

Figure 6. L6590 signals @FULL LOAD



Output voltage measurement and efficiency calculation @normal operation

In the following table the output voltage cross regulation is measured and the overall efficiency of the converter is calculated at both the nominal input voltages. The output voltages have been measured after the load connector.

	5V		12V		Pout _{TOT} [W]	115Vac	
						Pin [W]	η
	Vout	@Iout	Vout	@Iout			
	[V]	[A]	[V]	[A]			
full load	4.99	1.400	12.11	0.304	10.67	15.12	70.6%
half load	5.01	0.650	11.97	0.15	5.05	7.00	72.2%

	5V		12V		Pout _{TOT} [W]	220Vac	
						Pin [W]	η
	Vout	@Iout	Vout	@Iout			
	[V]	[A]	[V]	[A]			
full load	4.99	1.400	12.11	0.304	10.67	14.90	71.6%
half load	5.01	0.650	11.99	0.15	5.05	6.90	73.3%

The output voltages are within the tolerances in all conditions, at both full and half load. The efficiency calculated is good for this kind of converters, then the power dissipation is low and even this affect positively the long-term reliability of the circuit.

Output voltage measurement and efficiency calculation @stand-by operation

Like in the previous section, the output voltage and the efficiency have been checked and the input power has been measured. It is clearly visible that with the required stand-by load (5V@50mA and 12V@0mA) the input power consumption is well below 1W at both the input voltage range. Besides, the circuit has been characterised at both the nominal input voltage values for different output load, giving very interesting results:

5V		12V		Pout _{TOT} [W]	115Vac	
Vout	@Iout	Vout	@Iout		Pin [W]	η
[V]	[mA]	[V]	[mA]			
5.02	10	11.92	0	0.050	0.288	17.4%
5.02	30	12.35	0	0.151	0.430	35.0%
5.02	50	12.65	0	0.251	0.579	43.3%
5.02	80	13.06	0	0.402	0.795	50.5%
5.02	100	13.27	0	0.502	0.941	53.4%

AN1523 APPLICATION NOTE

5V		12V		Pout _{TOT}	220Vac	
Vout	@ Iout	Vout	@ Iout		Pin	η
[V]	[mA]	[V]	[mA]	[W]	[W]	
5.02	10	11.95	0	0.050	0.330	15.2%
5.02	30	12.34	0	0.151	0.474	31.8%
5.02	50	12.66	0	0.251	0.627	40.0%
5.02	80	13.06	0	0.402	0.842	47.7%
5.02	100	13.28	0	0.502	0.986	50.9%

the circuit efficiency is always high and the input power is lower than 1W with twice the specified stand-by load. In figure 7 the input power as a function of the 5V current, without load on the 12V is represented. The only shortcoming is the 12V variation: the 12V increases above its limit when the +5V current exceeds 50mA, due to coupling between the transformer windings. A bit heavier bleeder on the 12V solves this problem very easily. Decreasing the R8 to 1.2kΩ or providing for the same residual load, brings the mains power consumption to **1.06W @220Vac delivering 5V@100mA, or to 0.69W @220Vac delivering 5V@50mA**. At the opposite, accepting an higher voltage variation of the 12V, it decreases the input power significantly: increasing R8 to 10KΩ when delivering **5V@100mA, decrease the consumption to 0.935W@220Vac**. Hence, a compromise between the bleeder resistors and the residual loads can be easily found giving the best results in stand-by. In fact, if a stable load is present on the 5V and we remove the 5V bleeder (R8), delivering **5V@100mA the consumption becomes 0.886W@220Vac**.

Figure 7. Input power @stand-by

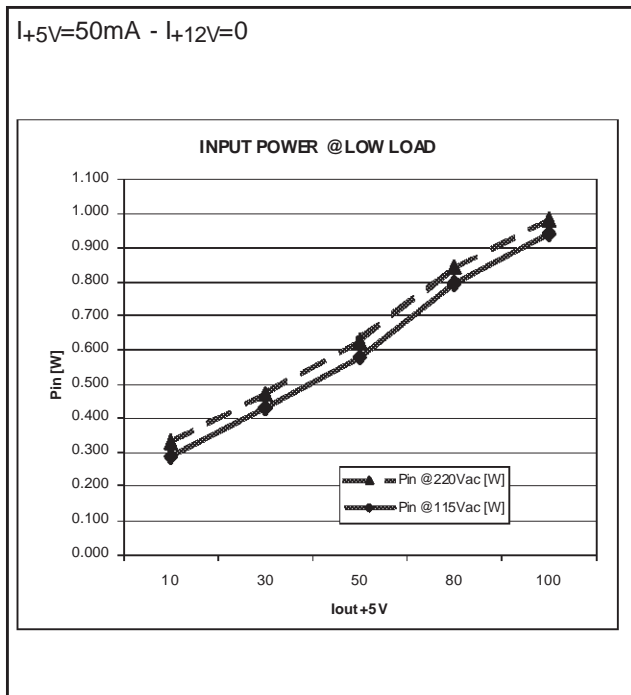
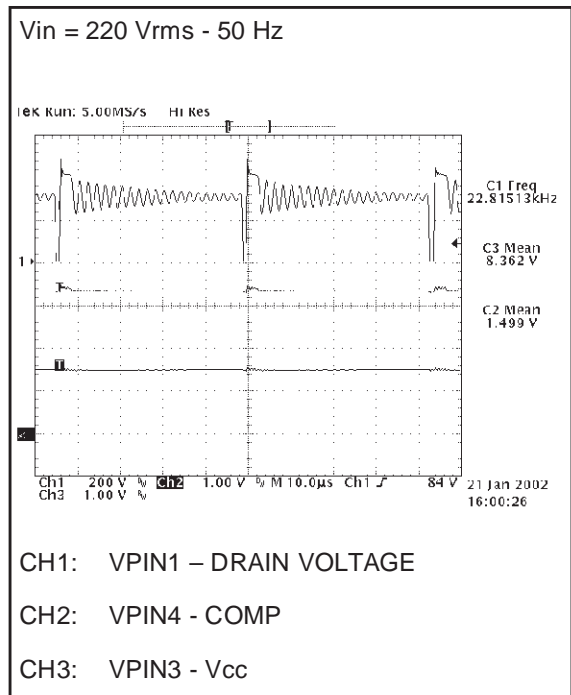

Figure 8. L6590 signals @ I+5V=50mA-I+12V=0



In figure 8 there are the waveforms relevant to the L6590 during standby operation: it is easy to recognize that the switching frequency has decreased from the initial value to about 22KHz. This feature is very important to



decrease the switching losses during light load operation, thus improving the stand-by efficiency. For reference, also the V_{comp} and the V_{cc} are captured. In detail, the V_{cc} shows that there is still margin when working at light load respect to the V_{ccoff} value (which is 6.5V typ. and 7Vmax.). This guarantees that even with a different transformer batch, delivering may be a bit lower V_{cc} , the converter will still work correctly, without showing any irregular behaviour at start-up or inopportune missing start-up due to a V_{cc} too low, unable to power correctly the primary controller.

Output voltage ripple @full load

In Figure 9 the output voltage ripple at switching frequency have been measured. As per the previous measures, the probes have been connected on test points after the output connector. The ripple and the spikes are very low making this design suitable to power sensitive loads. In Figure 10, the residual ripple on the output voltages at mains frequency is measured. The low frequency residual ripple compared with the 100Hz undulation across C1 (input Elcap), demonstrates an excellent rejection of the circuit (~66dB) at 115V. Obviously the low frequency rejection becomes even higher when the circuit is working at 220Vac (figure 10). At that voltage, the rejection becomes 76dB and this means a residual line ripple on the 5V output of 3mV only.

Figure 9. HF RIPPLE

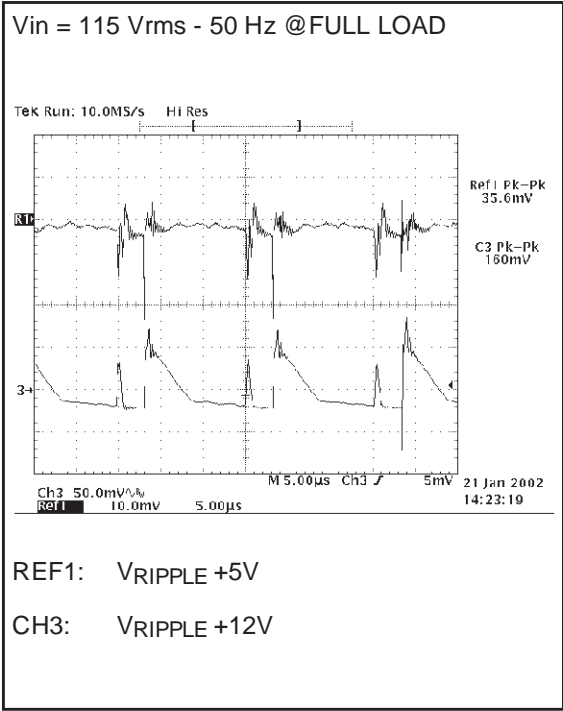
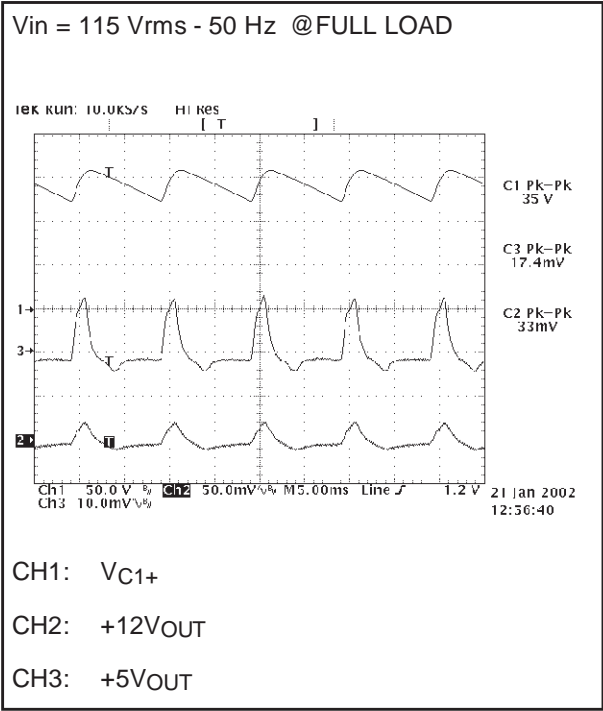

Figure 10. LINE RIPPLE REJECTION



AN1523 APPLICATION NOTE

Dynamic Load Tests

Load condition: +12V: FULL LOAD
 +5V: LOAD 50% ÷ 100%, 12Hz

Figure 11. DYNAMIC LOAD TEST

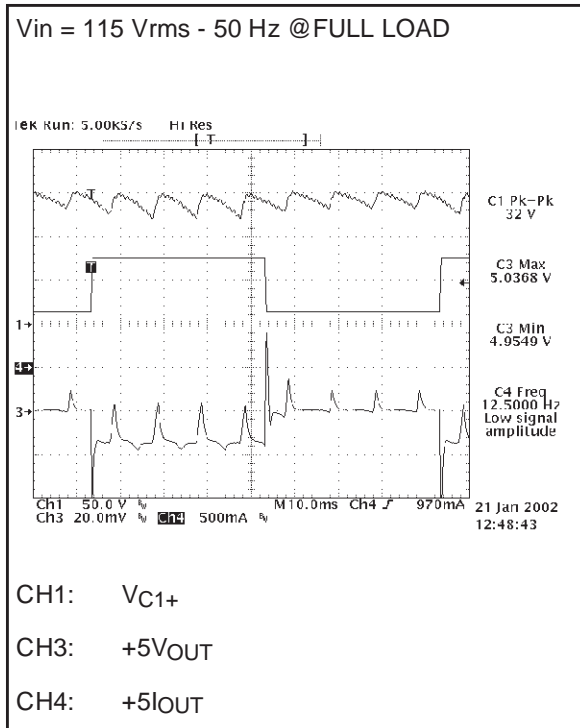
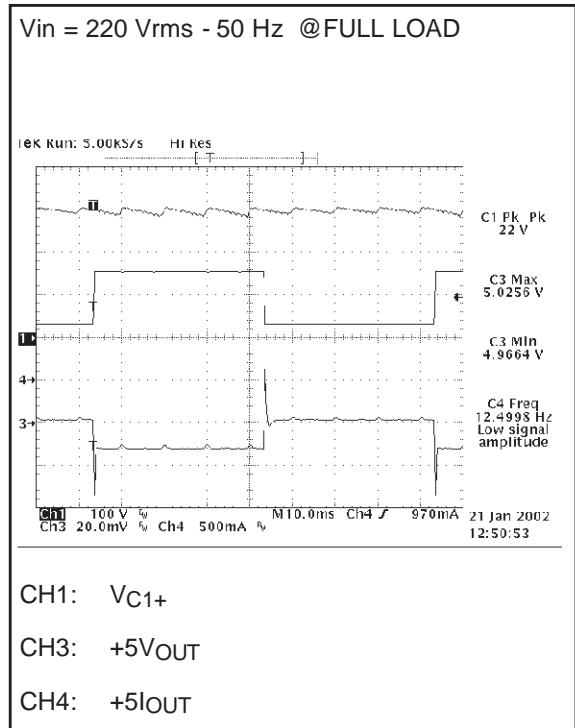

Figure 12. DYNAMIC LOAD TEST



The pictures 11 and 12 show the output voltage regulation against a dynamic load variation of +5V output, at the nominal mains voltage values. As shown in the pictures, the voltage variation is always better than 1% and the response is fast, within 2 ms. This allows to power μ P or any logic circuitry without the risk of inopportune reset or logic malfunctioning. Even the 12V variation is good, remaining within its tolerance with still margin.

Start-Up Behaviours @full load

In figure 13 and 14 there are the rising slopes at full load of the output voltages at nominal input mains voltages. As shown in the pictures, the rising time at 220Vac is a bit faster than at 115Vac, however they are similar. The rising slopes are always monotonic overall the input mains range. This characteristic is quite important powering a μ P and its peripherals as in this case, thus avoiding problem at start-up for the equipment.

In figure 15, there are the same waveforms captured during the start-up in stand-by. Even in this case, the behaviour of the circuit is always correct overall the input mains range.

A slight overshoot is present in all conditions but it is negligible because the voltage remains always under control and the variation is within the tolerances.

Figure 13. START-UP BEHAVIOUR

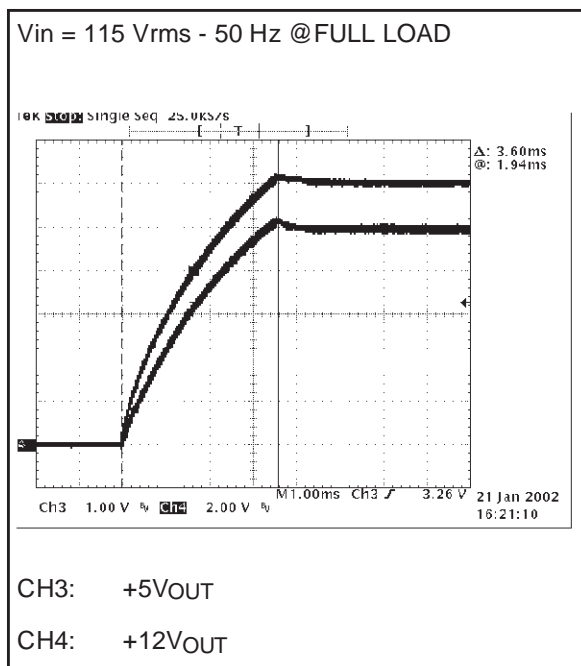

Figure 14. START-UP BEHAVIOUR

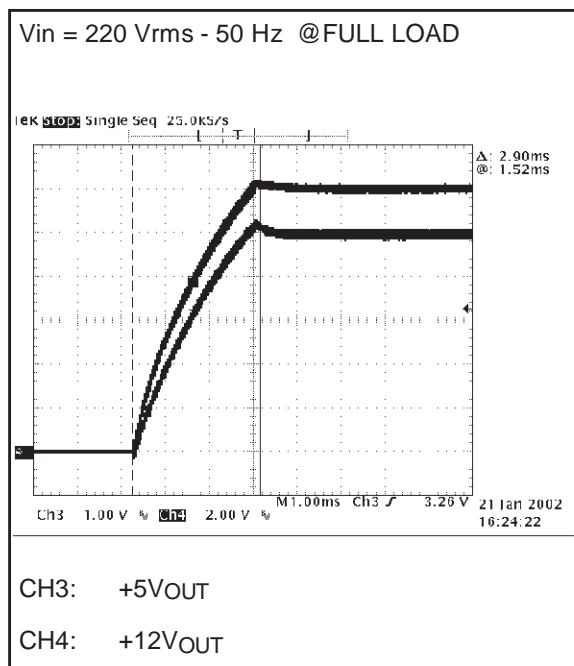
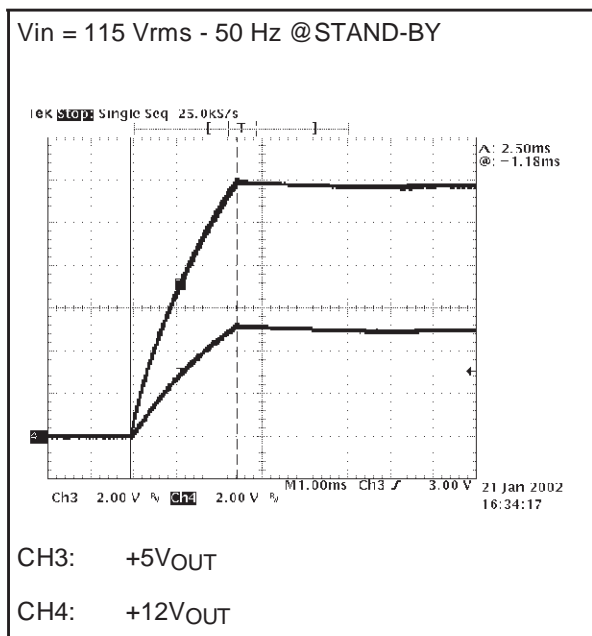

Figure 15. START-UP BEHAVIOUR



Wake-up time

In the following picture (Figure 16), there are the waveforms with the wake-up time measured at 115V input mains. Thanks to the L6590 internal current source, the capacitor C2 is charged with a constant current, independent from the input mains value. This means that the power supply wake-up time is perfectly constant. Thus, the annoying problem of a very long start-up time, especially at low mains, is solved without adding any additional extra component. Besides, it is a key feature during stand-by operation because it is disconnected from the mains helping a lot the power consumption decreasing.

The measured time in Figure 16 at 115Vac is less than 150ms but it doesn't show variations from 88 to 265 Vac.

The traces shown in Figure 16 are the drain voltage, the Vcc and the +5V output: on the picture is clearly visible that no overshoots, undershoots, dips or any lost of control happens during the power supply start-up phase and the circuit starts correctly overall the input mains range

Figure 16. WAKE UP TIME

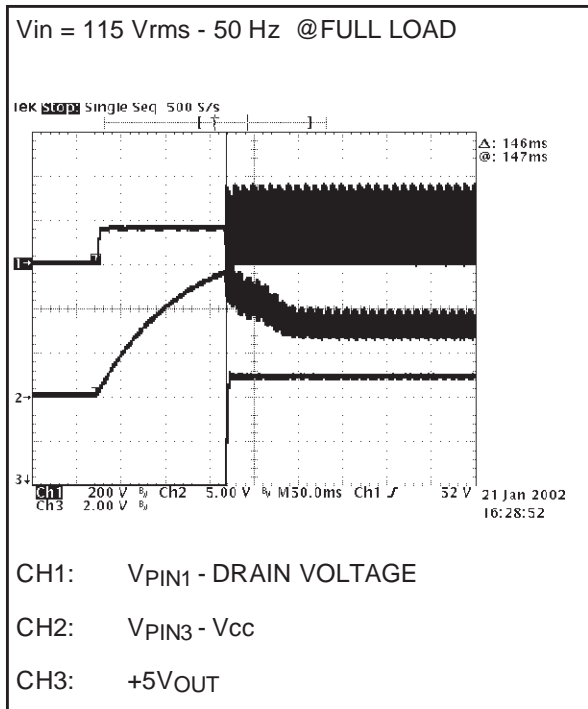

Turn-Off

Even at turn off the transition is clean, without any abnormal behaviour like overshoots or glitches both on the output voltages. Checking the full load condition, a restart attempt is present on the Vcc voltage: it is due to the circuit Q1, Q2,R9, R10, R11, C6 connected to the COMP pin. During the switching off phase the energy in the bulk capacitor is no more refreshed, then the voltage on it starts to decrease. This provides for an increasing of the COMP pin voltage due to the loop intervention which is regulating the output voltage while the input voltage is decreasing. At a certain value the COMP voltage is able to switch on Q1 and then Q2, thus disconnecting the transformer from Vcc, so that the L6590 stops the operation. Because the circuit is switched off externally, the bulk capacitor has still some energy stored and when the Vcc has dropped below the Vccoff the IC detects that residual input voltage higher than its Drain start voltage (Vdsmin). Hence the L6590 reactivates the internal current source like in a normal start-up, and the voltage on the Vcc pin tends to increase again. But checking the Fig. 17 it is important to note that the Vcc value is far from the Start Threshold voltage (Vccon), then no any perturbation appears on the output, avoiding any problem..

Figure 17. TURN-OFF

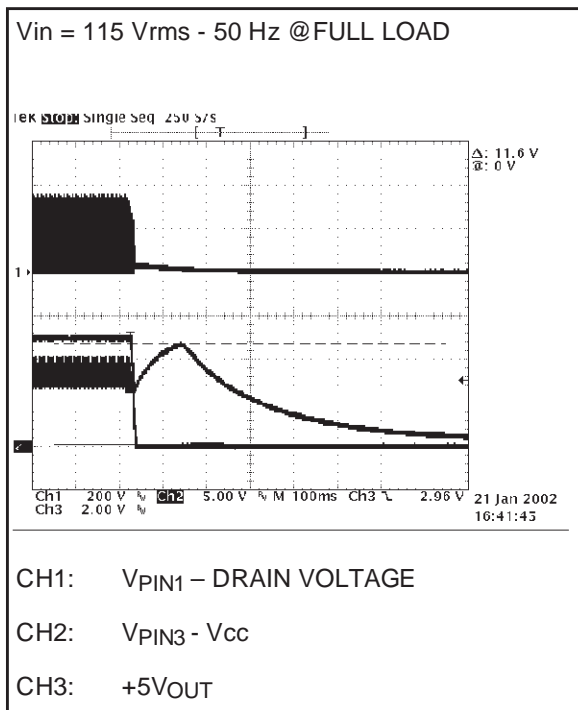
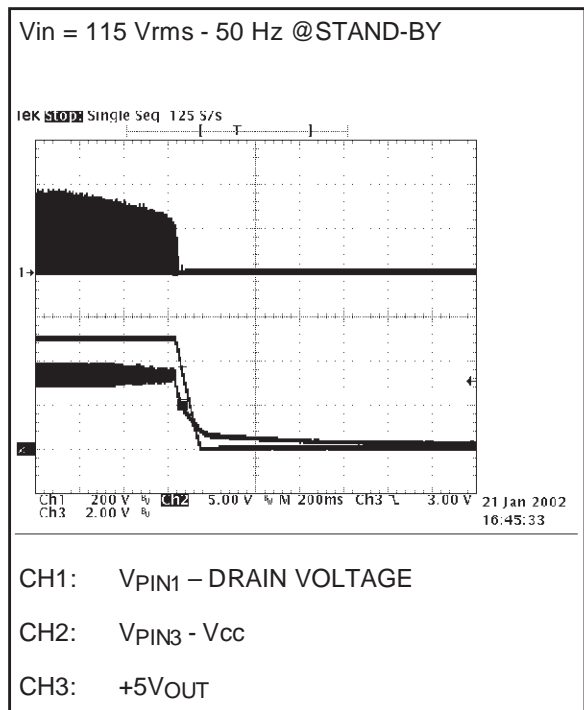

Figure 18. TURN-OFF



Short-Circuit Tests @ Full Load

The short circuit tests have been done in two phases, making the test shorting by a power switch the output electrolytic capacitor or making the short by the active load option. This gives an idea about the circuit behaviour with a hard short (at very low impedance) or with a "soft" short that could happen on the STB main board, having slightly higher impedance. All the tests have been done at maximum, nominal and minimum input voltage. For all conditions the drain voltage is always below the BV_{DSS} , while the mean value of the output current has a value close to the nominal one, thus preventing component melting for excessive dissipation in case of long term shorts. The auto-restart is correct at short removal in all conditions.

Figure 19. SHORT ON +5V

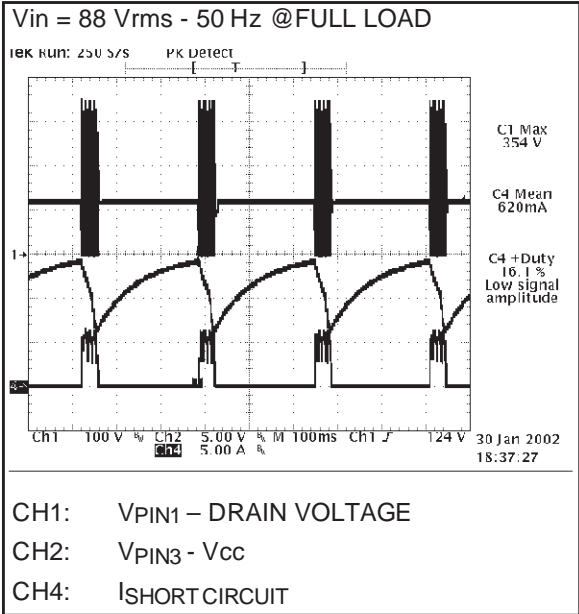

Figure 20. SHORT ON +5V

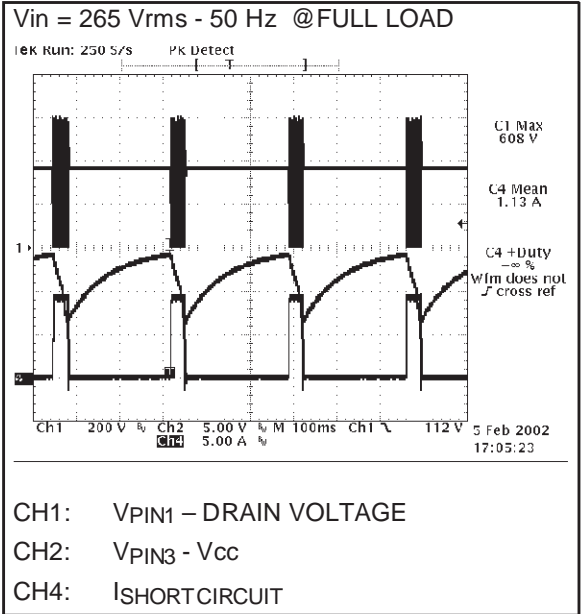

Figure 21. SHORT ON +12V

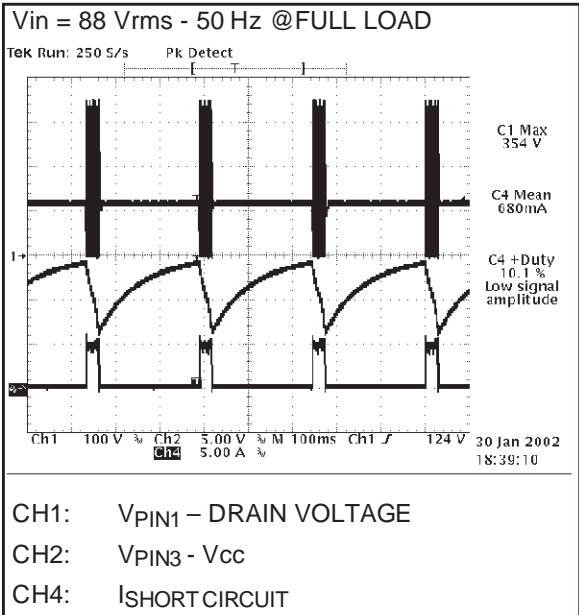
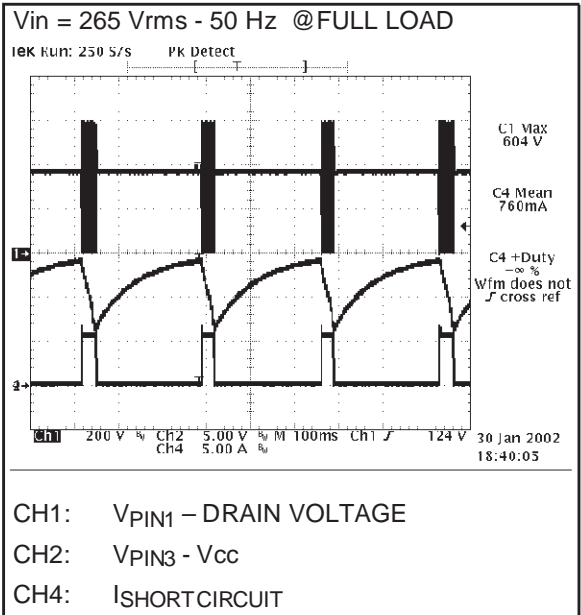

Figure 22. SHORT ON +12V



AN1523 APPLICATION NOTE

As clearly indicated by the waveforms, the circuit starts to work in hiccup mode, keeping the current mean value of the shorted output at levels within component rating. Because the working time and the dead time are imposed by the charging and discharging time of the auxiliary capacitor C2, it is almost constant varying the input mains voltage thanks to the internal start-up current source already mentioned.

Short-Circuit Tests @ Stand-by

A short circuit when the SMPS works at light-load is always a critical fault condition for any power supply circuit. In this condition, the energy deliverable to the short is the maximum one, and then it is the most stressing situation for the output rectifiers and besides, sometimes the primary hiccup mode is not triggered. This may happen because the short circuit reflected impedance on the auxiliary winding it is not low enough for decreasing the Vcc voltage below the under-voltage lockout threshold or spikes are present at turn off on the auxiliary winding which are capable of powering the IC. The proposed circuit, even in this load condition, provides the same results as the previous tests, both at 115Vac and at 220 Vac, making it reliable in all the working situations independently from the transformer coupling.

Figure 23. SHORT ON +5V

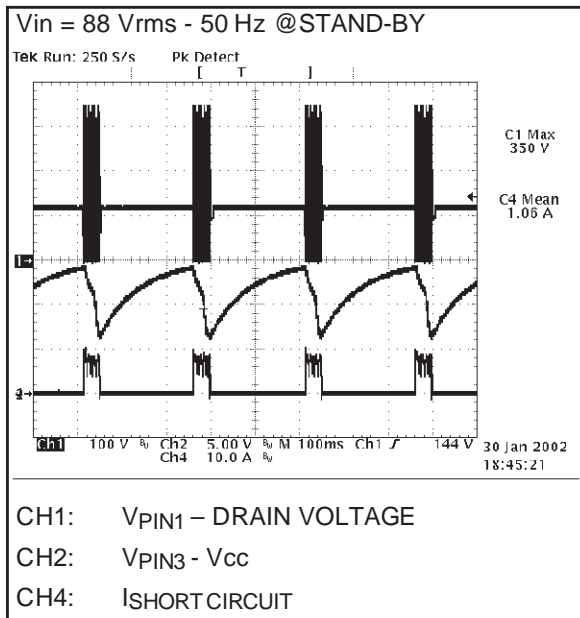
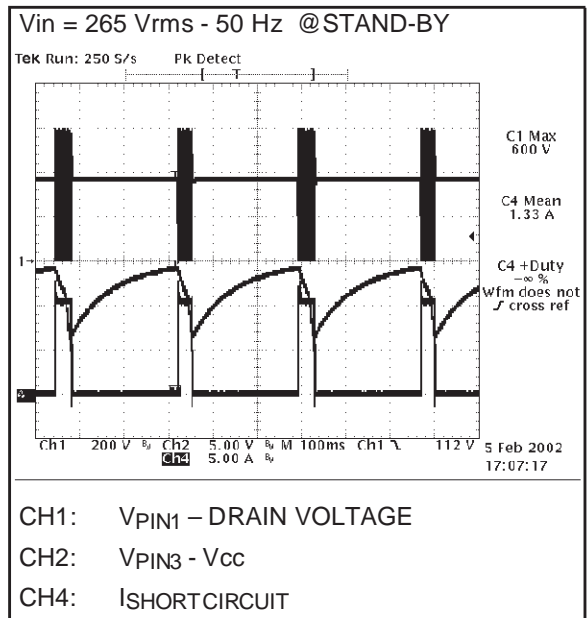

Figure 24. SHORT ON +5V



Short circuit of the output rectifiers

Another frequent problem in a power supply is relevant to the protection of the SMPS itself: thus sometimes it is easy to find circuits with a good protection capability against shorts of the load but which are not able to survive in case of a very hard short like an output electrolytic capacitor or a diode. Besides, in case of a rectifier shorted, the equivalent circuit of the basic converter changes: in fact, due to the missing (shorted) rectifier the energy stored is delivered even during the on time, like in forward mode with reverse polarity of the trafo. To insure reliable operation of the circuit, even this fault condition has been simulated (figure 25) shorting each rectifier, then has been proven that the circuit can withstand this failure without any performance degradation. The circuit in fact works in hiccup mode and then it restarts correctly to deliver the output voltages if the short is removed. This exceeds the requirements of the VDE and IEC safety rules, and ensures a considerable time saving during the qualification phase of the SMPS, avoiding failures during the qualification tests, retrofit and new testing, sometimes with a short time available to solve the issue.

Figure 25. SHORT ON +5V RECTIFIER

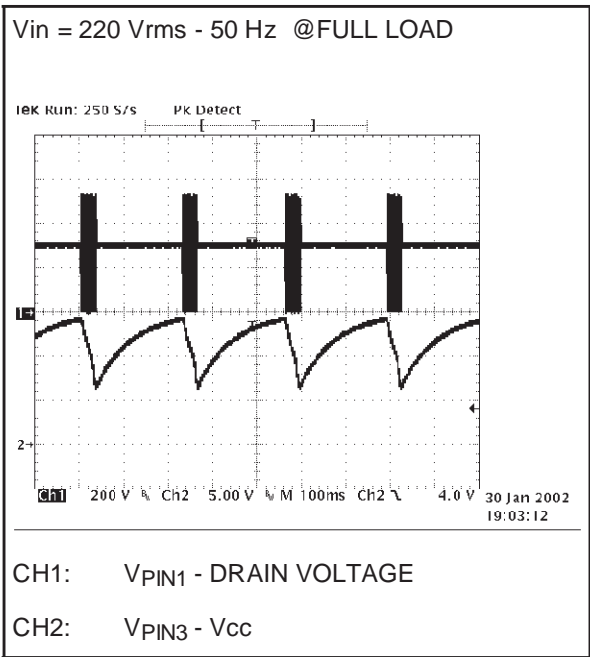

Switch On and Turn Off In Short Circuit Condition

The following pictures show the SMPS behaviour during the start-up phase with an output voltage shorted. As clearly visible the circuit starts correctly then it works in hiccup mode protecting itself. The start-up phase is clean in all conditions, without showing any dangerous transition for the SMPS circuitry.

Figure 26. SWITCH ON WITH +5V SHORTED

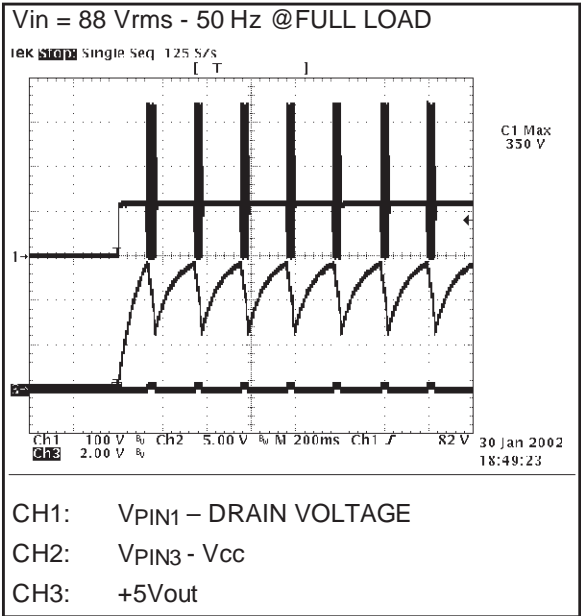

Figure 27. SWITCH ON WITH +5V SHORTED

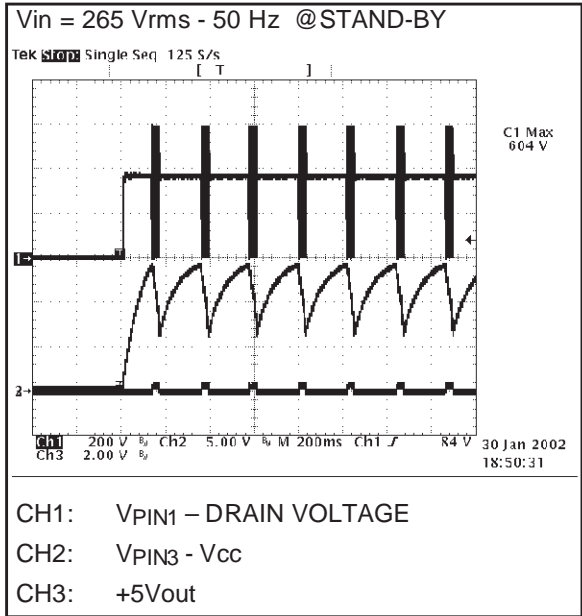

Figure 28. TURN-OFF WITH +5V SHORTED

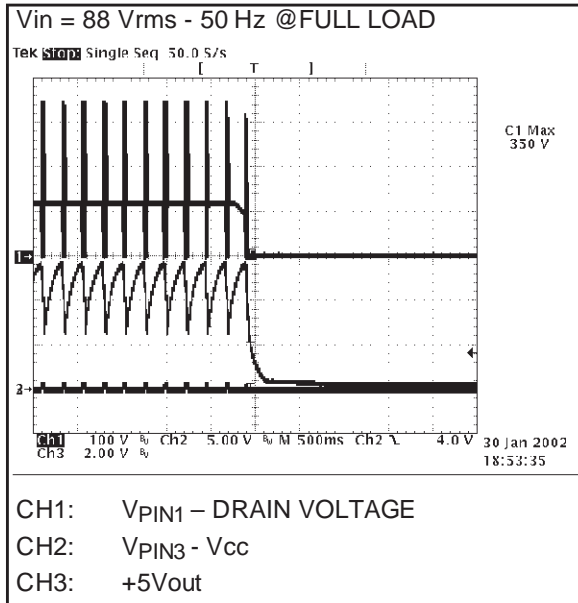
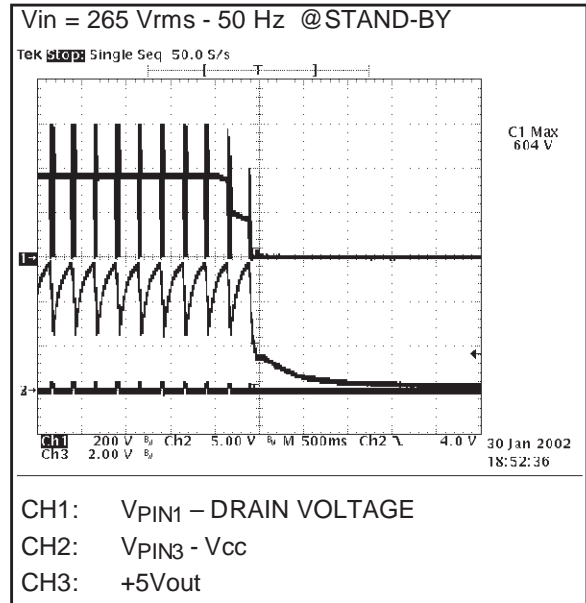

Figure 29. TURN-OFF WITH +5V SHORTED



Even at turn off in short circuit the SMPS functioning is good, protecting properly the circuit. No any abnormal transition or level has been observed during the tests, confirming the design robustness proven so far.

Over Voltage Protection

A dangerous fault that could happen is the failure of the feedback circuitry. If this occurs, the SMPS output voltages can get to very high values, depending on the load on each output and on the transformer coupling between the windings. Consequently, the rectifiers and the output capacitors are overstressed or damaged. A possible solution could be to oversize the components but this should be expensive and uneconomic. Hence, to avoid this SMPS failure a suitable protection circuit has been added inside the L6590 and it doesn't require any external component for the threshold setting. Hence, this fail has been simulated opening the feedback loop and the circuit has been tested, giving the results shown in figures 30 and 31:

Figure 30. OPEN LOOP

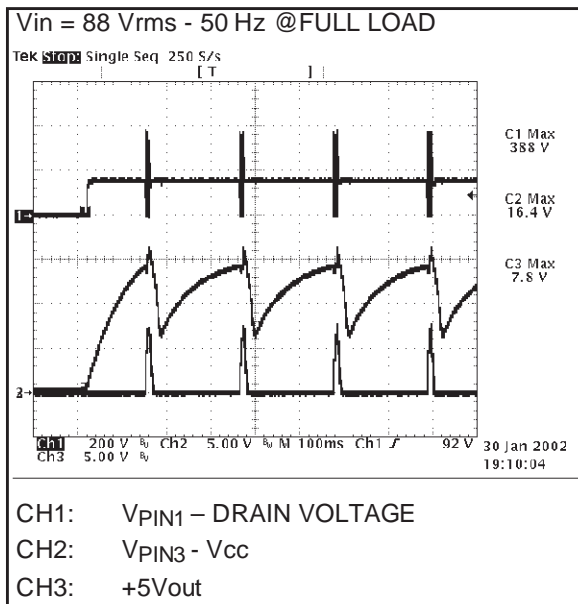

Figure 31. OPEN LOOP

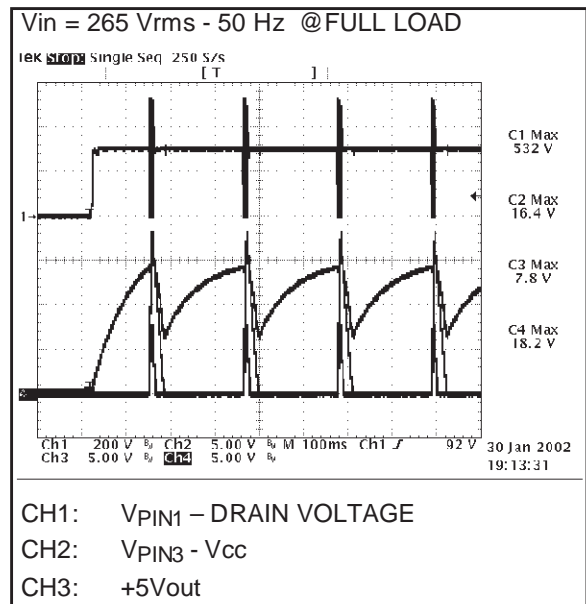
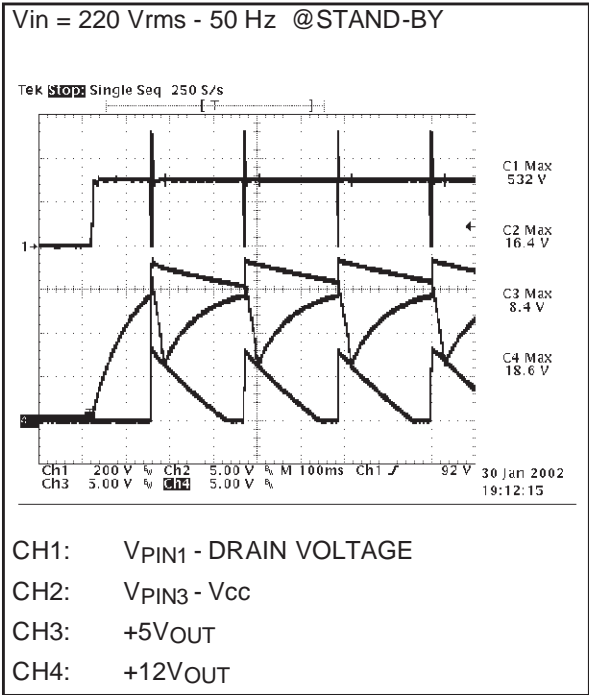

Figure 32. OPEN LOOP



The figure 32 has been acquired testing the open loop protection when working in stand-by: as visible, even in this condition the circuit stops the switching cycles when the Vcc reaches 16.5V and the value of the output voltages never overstress the output electrolytic capacitors.

In case a lower OVP threshold is required, it is possible to connect the inverting input of the E/A (VFB-pin 5) to ground via a resistor (e.g. 1KΩ) and a zener between the pin 5 and Vcc. A small ceramic capacitor in parallel to the resistor could be required. In this case the OVP threshold will be $V_{ZENER} + 2.5V$.

Conducted Noise Measurements (Pre-Compliance Test)

The following pictures are shown the quasi-peak conducted noise measurements at full load and standby with both nominal input mains voltages. The limits shown on the diagrams are referred to the EN55022 CLASS B, which is the most widely used for domestic equipment like a TV or a STB. As visible on the diagrams, there is a good margin of the measures with respect to the limits in overall conditions.

Figure 33. QUASI-PEAK MEASURE

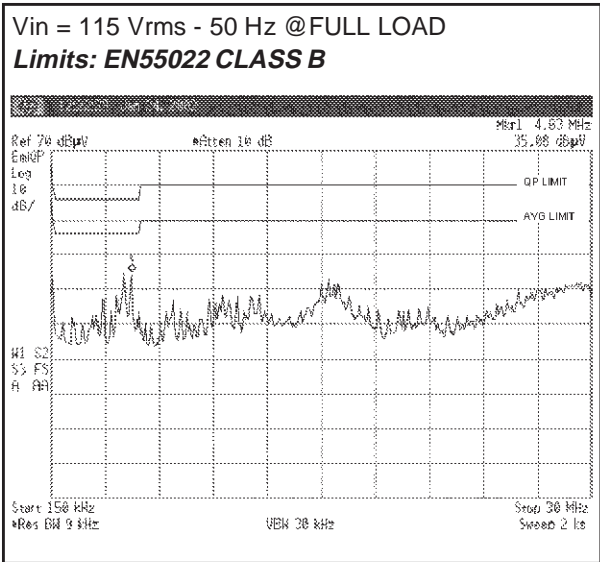

Figure 34. QUASI-PEAK MEASURE

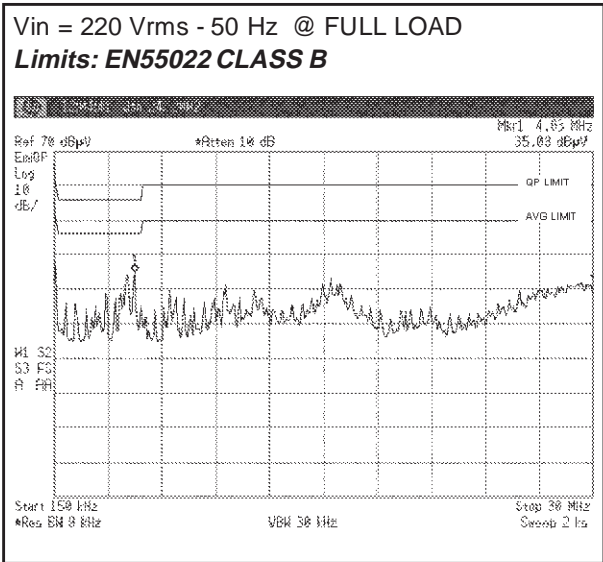

Figure 35. QUASI-PEAK MEASURE

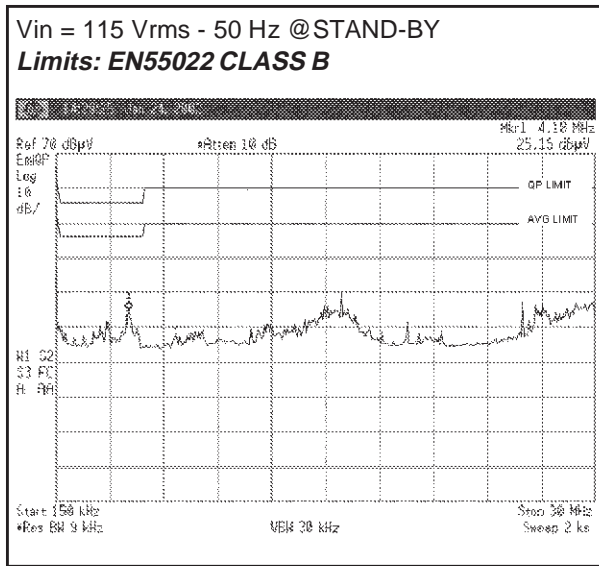
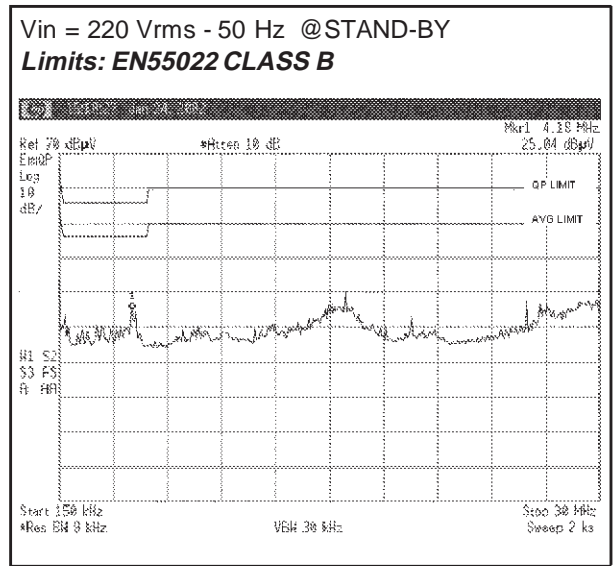

Figure 36. QUASI-PEAK MEASURE



Thermal measures

In order to check the reliability of the design, a thermal mapping by means of an IR Camera has been done. Here below the thermal measures on the board at both nominal input mains voltage at ambient temperature (25°C) are shown. The pointers A-D have been placed across some key components affecting the reliability of the circuit. The points correspond to the following components:

TESTED POINT		NOTES
A	IC1 - L6590	Copper dissipating area: 4 cm ²
B	D1 - BZW06-188	Lead length: 13mm each side – Diode mounted 7mm from the top of PCB surface
C	T1 - TRAFO	Checked the hottest point
D	D4 – BYW98-200	Lead length: 8 mm each side – Diode body placed on PCB surface

As shown on the maps, all the other points of the board are within the temperature limits ensuring a reliable performance of the devices. T_{AMB} = 25°C for all measures

Figure 37. TEMPERATURE IR MEASURE

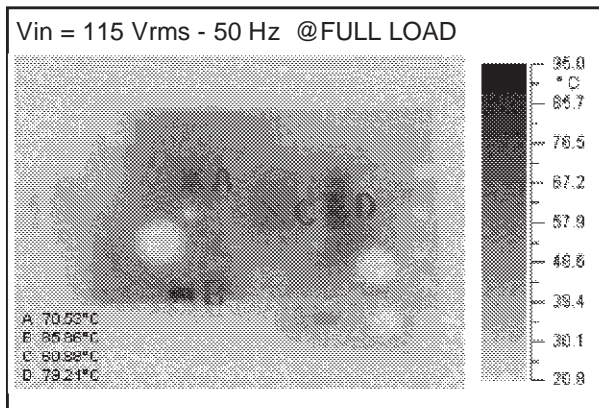
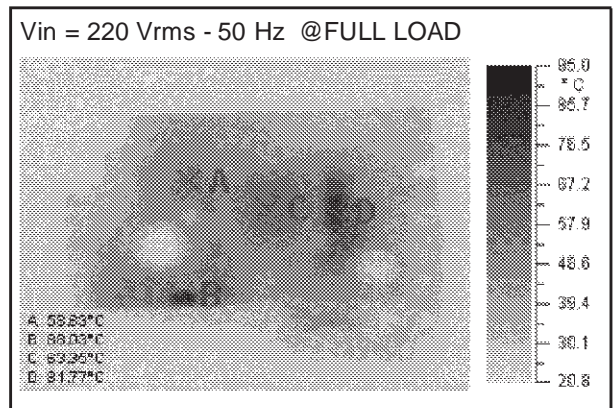

Figure 38. TEMPERATURE IR MEASURE



Conclusions

A SMPS for Consumer application has been completely designed and tested, checking the performance thoroughly. The test results has been positive and the initial requirements of high reliability, low cost and low complexity have been met successfully.

References

- [1] AN1261 - Getting familiar with the L6590 family high-voltage fully integrated power supply
- [2] AN1262 - Offline fly-back converters design methodology with the L6590 family

ANNEX1: Part List

	Designator	Part Type	Description	Supplier
1	C1	22uF-400V	ELCAP	ELNA
2	C10	330PF	CERCAP	AVX
3	C11	470uF-25V YXF	ELCAP	RUBYCON
4	C2	22uF-25V	ELCAP	ELNA
5	C3	2N2	CERCAP	AVX
6	C4	2N2-2KV (Y1)	CERCAP-SAFETY	CERA-MITE
7	C5	100N-250Vac - B81133	X CAP-MKT	EPCOS
8	C6	2u2-50V - YK	ELCAP	RUBYCON
9	C7	1000uF-25V YXF	ELCAP	RUBYCON
10	C8	220uF-10V-ZL	ELCAP	RUBYCON
11	C9	100NF	CERCAP	AVX
12	D1	BZW06-188	AXIAL TRANSIL DIODE	STMicroelectronics
13	D2	STTA106	ULTRA FAST REC. RECTIFIER	STMicroelectronics
14	D3	1N4148	GEN. PURPOSE DIODE	WISHAY
15	D4	BYW98-200	FAST REC. RECTIFIER	STMicroelectronics
16	D5	BYW100-200	FAST REC. RECTIFIER	STMicroelectronics
17	D6	DF04G	BRIDGE RECTIFIER	GEN. SEMICOND.
18	F1	FUSE1	T2A - 250V	
19	IC1	L6590_MINIDIP	INTEGRATED CONTROLLER	STMicroelectronics
20	IC2	TL431ACZ	SHUNT REGULATOR	STMicroelectronics
21	L1	B82731-R2501-A30	2*27mH FILTER COIL	EPCOS
22	L2	4.7uH ELC08D	INDUCTOR	PANASONIC
23	OPT1	PC817	OPTOCOUPLER	SHARP
24	Q1	BC548	SMALL SIGNAL BJT	ZETEX
25	Q2	BC548	SMALL SIGNAL BJT	ZETEX
26	R1	12R - 1/4W - 5%	SFR25	BEYSCHLAG
27	R10	33K - 1/4W - 5%	SFR25	BEYSCHLAG
28	R11	10K - 1/4W - 5%	SFR25	BEYSCHLAG
29	R12	NTC_10R S236	NTC THERMISTOR	EPCOS
30	R13	4K7 - 1/4W - 5%	SFR25	BEYSCHLAG
31	R2	6K8 - 1/4W - 5%	SFR25	BEYSCHLAG
32	R3	560R - 1/4W - 5%	SFR25	BEYSCHLAG
33	R4	2K4 - 1/4W - 1%	MBA0204	BEYSCHLAG
34	R5	1K0 - 1/4W - 5%	SFR25	BEYSCHLAG
35	R6	2K4 - 1/4W - 1%	MBA0204	BEYSCHLAG
36	R7	560R - 1/4W - 5%	SFR25	BEYSCHLAG
37	R8	2K7 - 1/4W - 5%	SFR25	BEYSCHLAG
38	R9	1K0 - 1/4W - 5%	SFR25	BEYSCHLAG
39	T1	2362.0019 rev.C	POWER TRANSFORMER	ELDOR CORPORATION
40			PCB - SINGLE SIDE - 70um - 100x50 mm	

ANNEX 2 - Switch Mode Transformer Specification



ELDOR CORPORATION S.p.A.
Via Plinio, 10
22030 ORSENIGO - Como - Italy
Tel. +39 031 636111 - Telefax +39 031 636263

COPIA ASSEGNATA A:
Copy assigned to:

SWITCH MODE TRANSFORMER SPECIFICATION

CODE : 2362.0019 C

FIRST ISSUE DATE : 12/02/2002

Table of contents:

- 1.0 GENERAL INFORMATION
- 2.0 ELECTRICAL CHARACTERISTICS
- 3.0 SAFETY
- 4.0 MATERIAL LIST
- 5.0 MECHANICAL CHARACTERISTICS

EVOLUZIONE DELLE REVISIONI / revision evolution:

DOCUMENTO N / document Nbr:

REV rev	DATA date	EMESSO DA: issued by:	VERIFICATO DA: checked by:	APPROVATO DA: approved by:	PAGINE MODIFICATE: changed pages:	DESCRIZIONE MODIFICA: change description:
A	12/02/02	GL. Verga				

ANNEX 2 - Switch Mode Transformer Specification (continued)

1.0 GENERAL INFORMATION

1.1 Description

The magnetic circuit comprises two soft ferrite E-cores glued together and gapped on the central leg. The windings are placed concentrically on single plastic bobbin made in self extinguish material. The transformer comply with the standard (Refer to pharagraf "3.0 SAFETY") for the component connected to the mains because:
 the use of triple insulation wire (three different layers) for the secondary winding.
 the thickness of insulation that exceed 0.40 mm.
 the shape of coilformer that maintain the safety creeping distance from the core , that is consired belong the primary side, and the secondary output pins and the circuit components.
 Winding outputs are made through 8 pins placed in two parallel rows (Refer to page 6).

1.2 Application

The transformer is designed for use in a switch mode flyback power supply.

1.2.1 Operating conditions

Operating ambient temperature: 0°C to +60°C
 Operating humidity range non condensing 10% to 85%RH

Ambient temperature is the medium value measured at 30 mm. of distance from the surface of the transformer. When the transformer is placed inside a metallic shield the above temperature value will be referred to the inside of the shield even if it is closer then 30 mm to the SMT.

1.3 Storage conditions

Storage temperature -20°C to +50°C
 After storage to allow a minimum of 24 hours recovery time before testing.

1.4 Marking

The component is marked with:
 - Eldor part number and customer part number (if required).
 - Production date.

1.5 Packaging

TDB

1.6 Weight

The transformer weight is approx 15g.

	SWITCH MODE TRANSFORMER SPECIFICATION 2362.0019 C	
	CUSTOMER CODE	ISSUE A
<small>This document and its content are property of ELDOR CORPORATION S.p.A. No part of this document may be reproduced, published, disclosed or used in any form with out written permission of ELDOR CORPORATION S.p.A.</small>		DOC.N. PAG. 2 / 6

AN1523 APPLICATION NOTE

ANNEX 2 - Switch Mode Transformer Specification (continued)

2.0 ELECTRICAL CHARACTERISTICS

For pins identification refer to mechanical drawing

2.1 Static characteristics

2.1.1 Inductance and DC resistance:

Measurement of inductance is made using a LCR bridge at frequency of 10KHz at output voltage of 1 V r.m.s.
 Measurement of resistance is made using a four wire ohmmeter.
 Temperature should be $23 \pm 2^\circ\text{C}$.

	L(mH)	tol(%)	R(Ω)	tol(%)
Between pin 2 and pin 1	2.0	± 10	2.31	± 15

2.1.2 Leakage Inductance:

$$L_L = 6 \% L_p \text{ (pin 2 pin 1)}$$

Measurement is made with the secondary windings short circuited.
 Measurement of inductance is made using a LCR bridge at frequency of 10 kHz and at output voltage of 1 V R.M.S.

2.1.3 Withstanding voltage

The transformer shall withstand a voltage of 3.75kV RMS for 60 seconds between primary winding and secondary windings.
 The frequency of the test voltage shall be 50 or 60Hz.

2.2 Test circuit diagram and application conditions

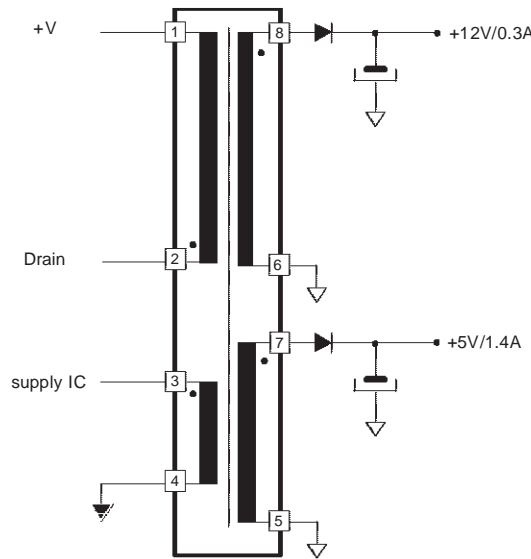

	SWITCH MODE TRANSFORMER SPECIFICATION	2362.0019 C
	CUSTOMER CODE	ISSUE A
<small>This document and its content are property of ELDOR CORPORATION S.p.A. No part of this document may be reproduced, published, disclosed or used in any form without written permission of ELDOR CORPORATION S.p.A.</small>		DOC.N. PAG. 3 / 6

ANNEX 2 - Switch Mode Transformer Specification (continued)

2.3 Temperatures

2.3.1 Temperature raise of the primary coil

The raising in primary winding shall be made in the following condition: Vin nom. and all loads at maximum current, except that for the Audio output that must be adjusted at 50% Imax. Raise of temperature after 4 hours must be lower than **55°C**

2.3.2 Maximum allowable temperatures

In the application, TV set with cabinet closed, at the maximum allowable ambient temperature (See IEC68-1 clause 4.6.2) and at the maximum working conditions (see § 2.3.1) after 4 hours the temperature of the transformer must be **≤ 115°C**.

To satisfy the above conditions it is recommended to provide the SMT with sufficient cool air flow around it.

2.4 Core saturation

Test must be performed in the following way:

- a) The SMT must be placed in oven at ambient temperature of 100°C for 2 hours.
- b) Using the circuit as per figure, connect the primary winding to LCR meter operating at frequency of 1 kHz and output voltage of 1 V.
- c) Superimpose through the power supply a dc current and read on the LCR meter the correspondent value of the inductance. Do this up to a current value of I peak max input current.
- d) The value of the inductance must not shows saturation (0.7Lp).

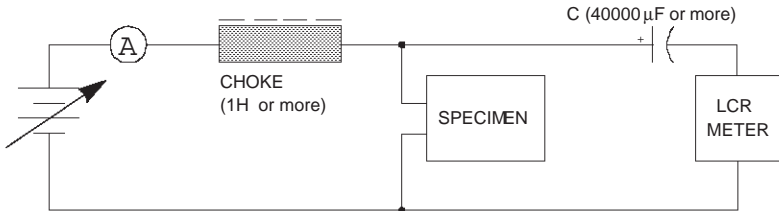

Saturation current @100°C

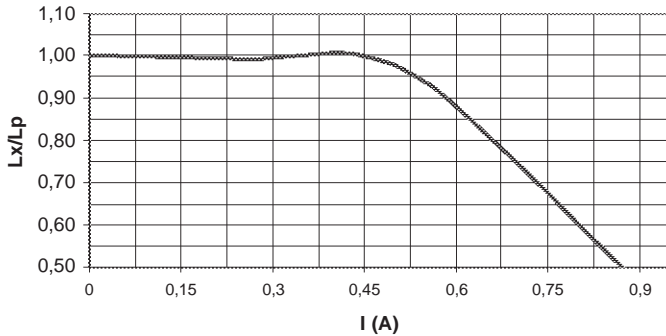

	SWITCH MODE TRANSFORMER SPECIFICATION	2362.0019 C
	CUSTOMER CODE	ISSUE A
<small>This document and its content are property of ELDOR CORPORATION S.p.A. No part of this document may be reproduced, published, disclosed or used in any form without written permission of ELDOR CORPORATION S.p.A.</small>		DOC.N. PAG. 4 / 6

AN1523 APPLICATION NOTE

ANNEX 2 - Switch Mode Transformer Specification (continued)

3.0 SAFETY

According to international standard EN60065- EN60950 for the Class II at the following conditions of primary voltage: $V_{RMS} < 300V$; $V_p < 600V$

All the transformers are tested at the end of the manufacturing lines for the withstanding voltage in between primary and secondary in the following conditions:

Test voltage = 4.2 kV RMS

Duration of test = 1 seconds

File records of the test are maintained in Eldor Quality Assurance Dept.

4.0 MATERIAL LIST

NR.	SMT PART NAME	KIND OF MATERIAL	MANUFACTURER	TRADE MARK/TYPE	UL RATING	UL FILE NUMBER
1	BOBBIN	Polyamide 4/6 (PA4/6)	DSM	Stanyl TE250F6	94V-0	E119177
2	INSULATING TAPE	Polyester film	3M	1350	UL 130°C	E17385
3	TERMINAL PINS	Tinned steel				
4	FERRITE CORE	N67 or equivalent	Epcos AG, AVX, Samwha, Ferroxcube, ISU, DMEG, Tridelta or equivalent	E20/10/6		
5	PRIMARY WINDINGS	Enamelled wire Grade 2 - Class F	Elektrisola Atesina srl, Nexans, Pirelli cavi e sistemi or equivalent			
6	SECONDARY WINDINGS	Triple insulated wire	The Furukawa Electric	TEX-E		E206440
7	ADHESIVE		LOCTITE	Loctite 480		
8	ELASTIC ADHESIVE		3M	Scotch Grip EC -1022		
9	MARKING OR LABEL	Marking				

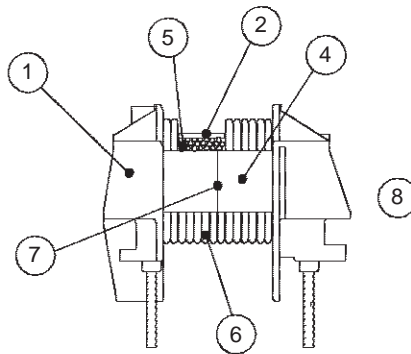



	SWITCH MODE TRANSFORMER SPECIFICATION	2362.0019 C
	CUSTOMER CODE	ISSUE A
<small>This document and its content are property of ELDOR CORPORATION S.p.A. No part of this document may be reproduced, published, disclosed or used in any form without written permission of ELDOR CORPORATION S.p.A.</small>		DOC.N. PAG. 5 / 6

ANNEX 2 - Switch Mode Transformer Specification (continued)

5.0 MECHANICAL DRAWINGS

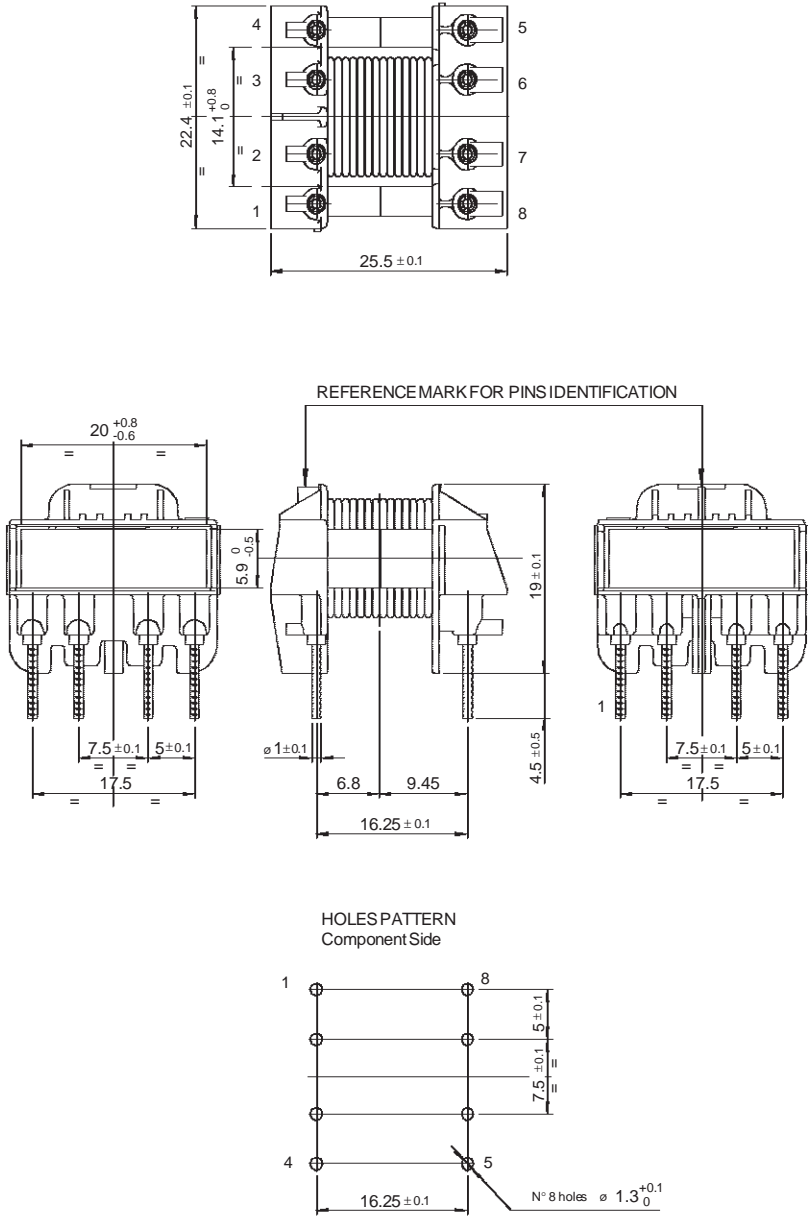
ALL DIMENSIONS IN mm
GENERAL TOLERANCE ± 0.2



	SWITCH MODE TRANSFORMER SPECIFICATION	2362.0019 C
	CUSTOMER CODE	ISSUE A
This document and its content are property of ELDOR CORPORATION S.p.A. No part of this document may be reproduced, published, disclosed or used in any form without written permission of ELDOR CORPORATION S.p.A.		DOC.N. PAG. 6 / 6

Information furnished is believed to be accurate and reliable. However, STMicroelectronics assumes no responsibility for the consequences of use of such information nor for any infringement of patents or other rights of third parties which may result from its use. No license is granted by implication or otherwise under any patent or patent rights of STMicroelectronics. Specifications mentioned in this publication are subject to change without notice. This publication supersedes and replaces all information previously supplied. STMicroelectronics products are not authorized for use as critical components in life support devices or systems without express written approval of STMicroelectronics.

The ST logo is a registered trademark of STMicroelectronics
© 2002 STMicroelectronics - All Rights Reserved

STMicroelectronics GROUP OF COMPANIES
Australia - Brazil - Canada - China - Finland - France - Germany - Hong Kong - India - Israel - Italy - Japan - Malaysia - Malta - Morocco -
Singapore - Spain - Sweden - Switzerland - United Kingdom - United States.
<http://www.st.com>