

**Silicon N-Channel MOSFET**

**Features**

- 9A,900V,  $R_{DS(on)}$ (Max1.35 $\Omega$ )@ $V_{GS}=10V$
- Ultra-low Gate charge(Typical 58nC)
- Fast Switching Capability
- 100%Avalanche Tested
- Maximum Junction Temperature Range(150 $^{\circ}C$ )

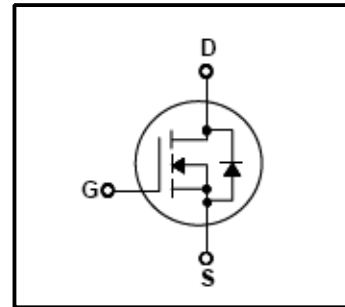

**General Description**

This N-Channel enhancement mode power field effect transistors are produced using Winsemi's proprietary, planar stripe ,DMOS technology. This advanced technology has been especially tailored to minimize on-state resistance , provide superior switching performance, and withstand high energy pulse in the avalanche and commutation mode. These devices are well suited for high efficiency switch mode power supplies.

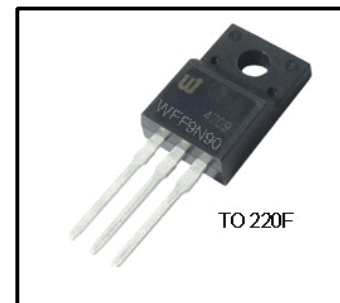

**Absolute Maximum Ratings**

Symbol	Parameter	Value	Units
$V_{DSS}$	Drain Source Voltage	900	V
$I_D$	Continuous Drain Current(@ $T_c=25^{\circ}C$ )	9*	A
	Continuous Drain Current(@ $T_c=100^{\circ}C$ )	5.7*	A
$I_{DM}$	Drain Current Pulsed (Note1)	27*	A
$V_{GS}$	Gate to Source Voltage	$\pm 30$	V
$E_{AS}$	Single Pulsed Avalanche Energy (Note2)	663	mJ
$E_{AR}$	Repetitive Avalanche Energy (Note1)	15	mJ
dv/dt	Peak Diode Recovery dv /dt (Note3)	4.5	V/ ns
$P_D$	Total Power Dissipation(@ $T_c=25^{\circ}C$ )	68	W
	Derating Factor above 25 $^{\circ}C$	0.54	W/ $^{\circ}C$
$T_J, T_{stg}$	Junction and Storage Temperature	-55~150	$^{\circ}C$
$T_L$	Channel Temperature	300	$^{\circ}C$

\*Drain current limited by maximum junction temperatruue

**Thermal Characteristics**

Symbol	Parameter	Value			Units
		Min	Typ	Max	
$R_{QJC}$	Thermal Resistance , Junction -to -Case	-	-	1.85	$^{\circ}C/W$
$R_{QJA}$	Thermal Resistance , Junction-to -Ambient	-	-	62.5	$^{\circ}C/W$

**Electrical Characteristics(Tc=25°C)**

Characteristics	Symbol	Test Condition	Min	Type	Max	Unit	
Gate leakage current	I <sub>GSS</sub>	V <sub>GS</sub> =±30V,V <sub>DS</sub> =0V	-	-	±10	nA	
Gate-source breakdown voltage	V <sub>(BR)GSS</sub>	I <sub>G</sub> =±10 μA,V <sub>DS</sub> =0V	±30	-	-	V	
Drain cut -off current	I <sub>DSS</sub>	V <sub>DS</sub> =720V,V <sub>GS</sub> =0V	-	-	100	μA	
Drain -source breakdown voltage	V <sub>(BR)DSS</sub>	I <sub>D</sub> =10mA,V <sub>GS</sub> =0V	900	-	-	V	
Gate threshold voltage	V <sub>GS(th)</sub>	V <sub>DS</sub> =10V,I <sub>D</sub> =1mA	3	-	5	V	
Drain -source ON resistance	R <sub>DS(ON)</sub>	V <sub>GS</sub> =10V,I <sub>D</sub> =4.5A	-	1.1	1.35	Ω	
Forward Transconductance	g <sub>fs</sub>	V <sub>DS</sub> =15V,I <sub>D</sub> =4.5A	3.0	7.0	-	S	
Input capacitance	C <sub>iss</sub>	V <sub>DS</sub> =25V,	-	2040	-	pF	
Reverse transfer capacitance	C <sub>rss</sub>	V <sub>GS</sub> =0V,	-	45	-		
Output capacitance	C <sub>oss</sub>	f=1MHz	-	190	-		
Switching time	Rise time	tr	V <sub>DD</sub> =400V, I <sub>D</sub> =9A R <sub>G</sub> =100Ω  (Note4,5)	-	25	-	ns
	Turn-on time	ton		-	60	-	
	Fall time	tf		-	20	-	
	Turn-off time	toff		-	95	-	
Total gate charge(gate-source plus gate-drain)	Q <sub>g</sub>	V <sub>DD</sub> =400V, V <sub>GS</sub> =10V,	-	58	-	nC	
Gate-source charge	Q <sub>gs</sub>	I <sub>D</sub> =9A	-	32	-		
Gate-drain("miller") Charge	Q <sub>gd</sub>	(Note4,5)	-	26	-		

**Source-Drain Ratings and Characteristics(Ta=25°C)**

Characteristics	Symbol	Test Condition	Min	Type	Max	Unit
Continuous drain reverse current	I <sub>DR</sub>	-	-	-	9	A
Pulse drain reverse current	I <sub>DRP</sub>	-	-	-	27	A
Forward voltage(diode)	V <sub>DSF</sub>	I <sub>DR</sub> =9A,V <sub>GS</sub> =0V	-	-	1.4	V
Reverse recovery time	trr	I <sub>DR</sub> =9A,V <sub>GS</sub> =0V,	-	1.6	-	ns
Reverse recovery charge	Q <sub>rr</sub>	di <sub>DR</sub> / dt =100 A / μs	-	20	-	μC

Note 1.Repeativity rating :pulse width limited by junction temperature

2.L=15mH I<sub>AS</sub>=9A,V<sub>DD</sub>=90V,R<sub>G</sub>=25Ω,Starting T<sub>J</sub>=25°C

3.I<sub>SD</sub>≤9A,di/dt≤200A/μs,V<sub>DD</sub><BV<sub>DSS</sub>,STARTING T<sub>J</sub>=25°C

4.Pulse Test:Pulse Width≤300us,Duty Cycle≤2%

5. Essentially independent of operating temperature.

This transistor is an electrostatic sensitive device

Please handle with caution

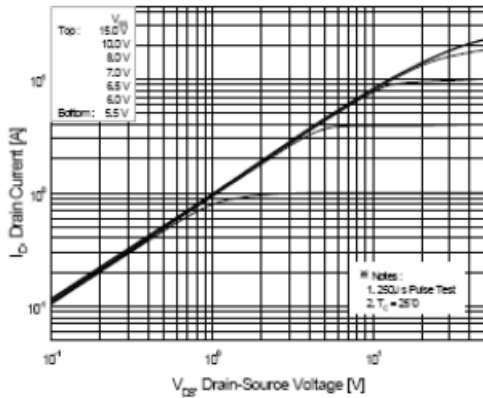

**Fig.1 On State Characteristics**

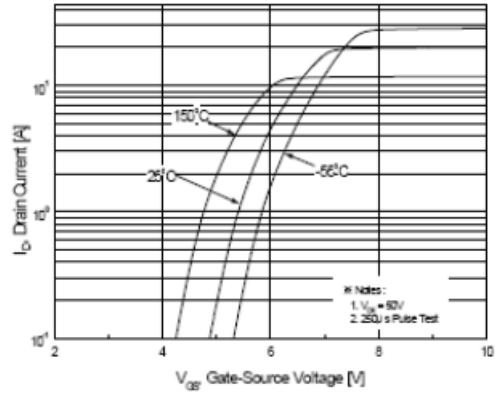

**Fig.2 Transfer Current Characteristics**

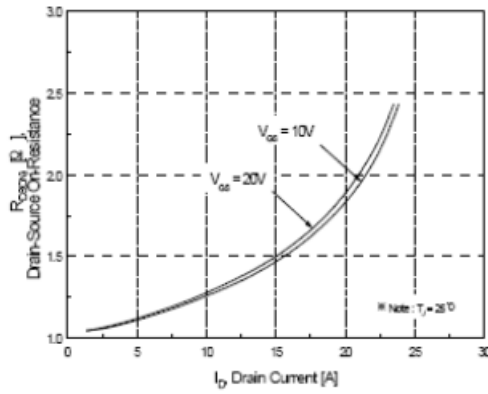

**Fig.3 On-Resistance Variation vs Drain current**

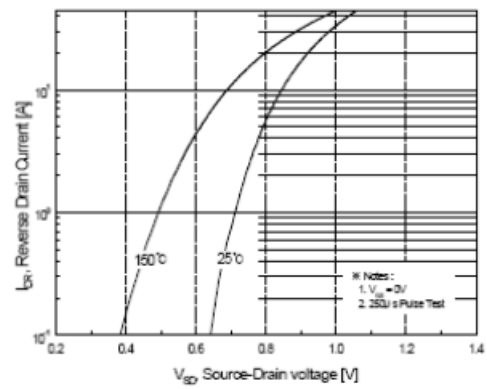

**Fig.4 Body Diode Forward voltage Variation with Source Current And Temperature**

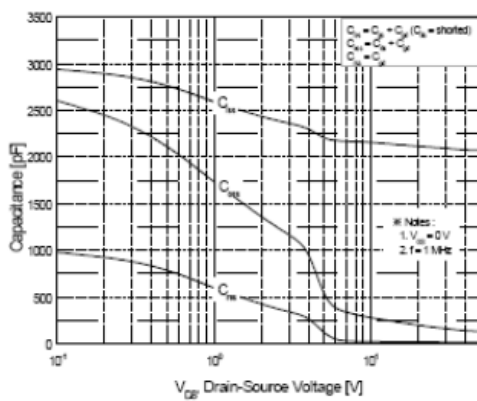

**Fig.5 Capacitance Characteristics**

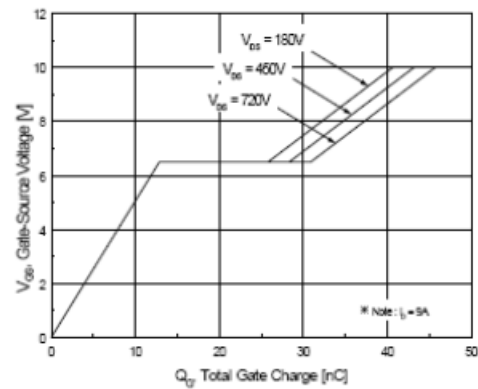

**Fig.6 Gate Charge Characteristics**

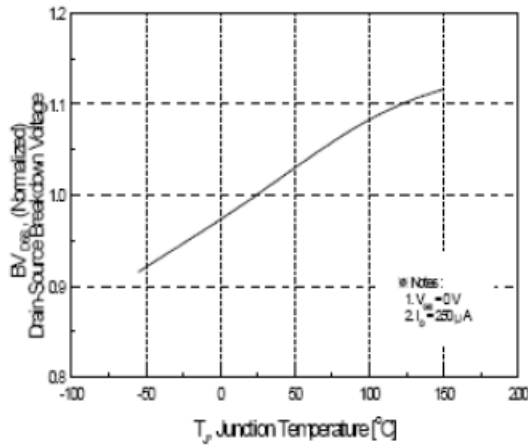

**Fig.7 Breakdown Voltage Variation**

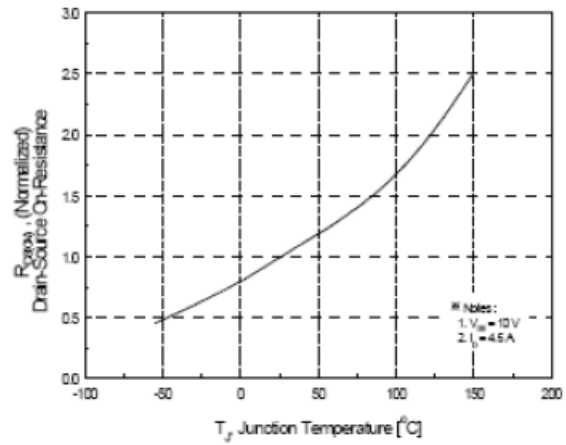

**Fig.8 On-Resistance Variation vs. Temperature**

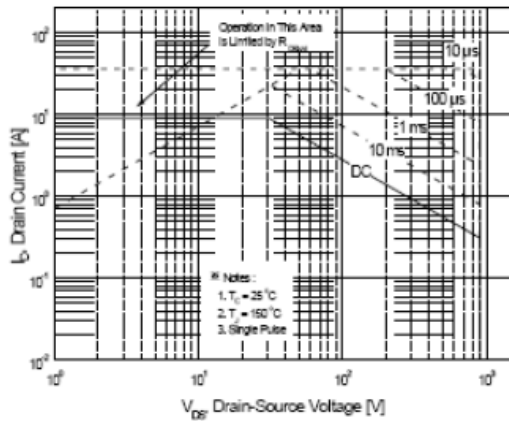

**Fig.9 Maximum Safe Operation Area**

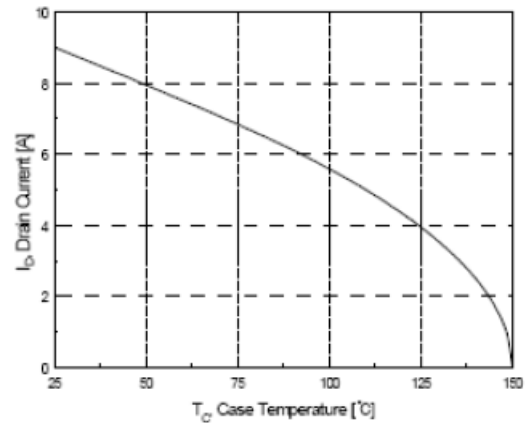

**Fig.10 Maximum Drain Current vs Case temperature**

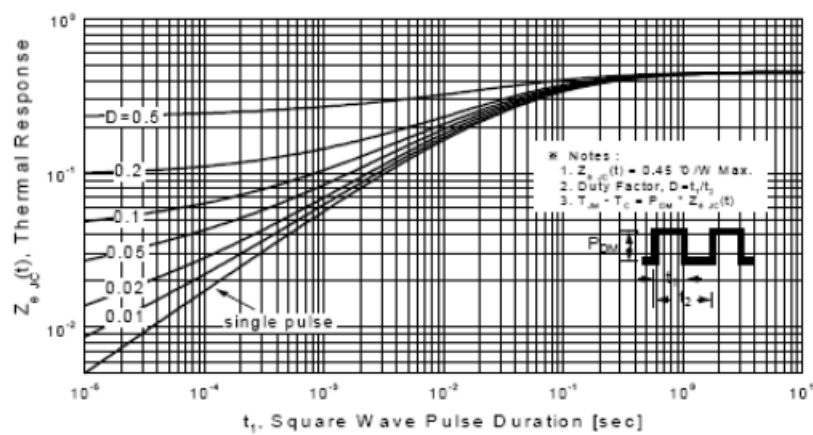

**Fig.11 Transient thermal Response Curve**

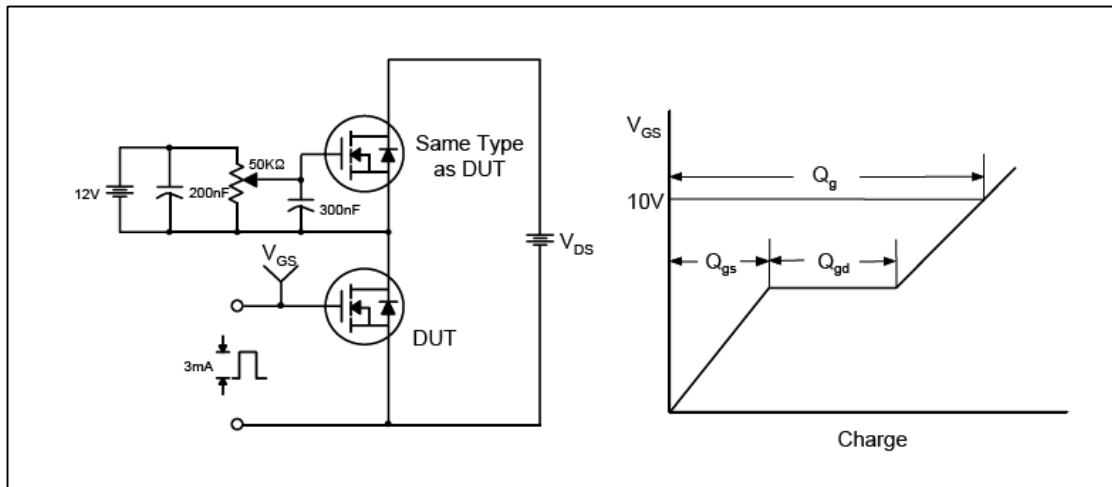

**Fig.12 Gate Test circuit & Waveform**

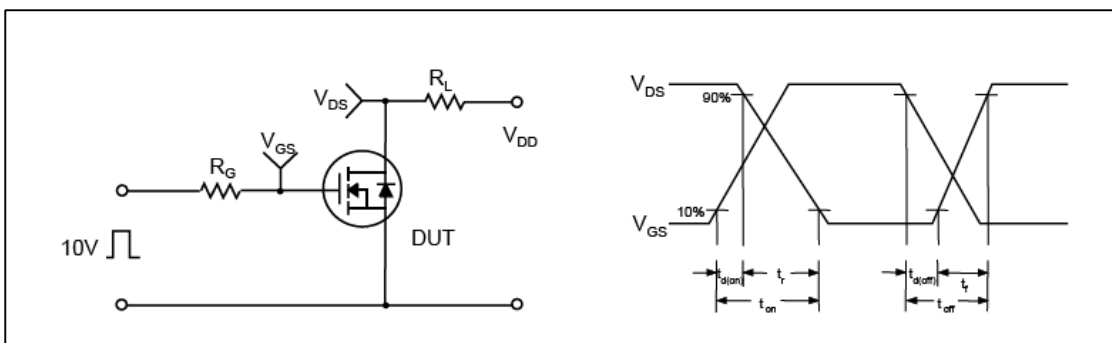

**Fig.13 Resistive Switching Test Circuit & Waveform**

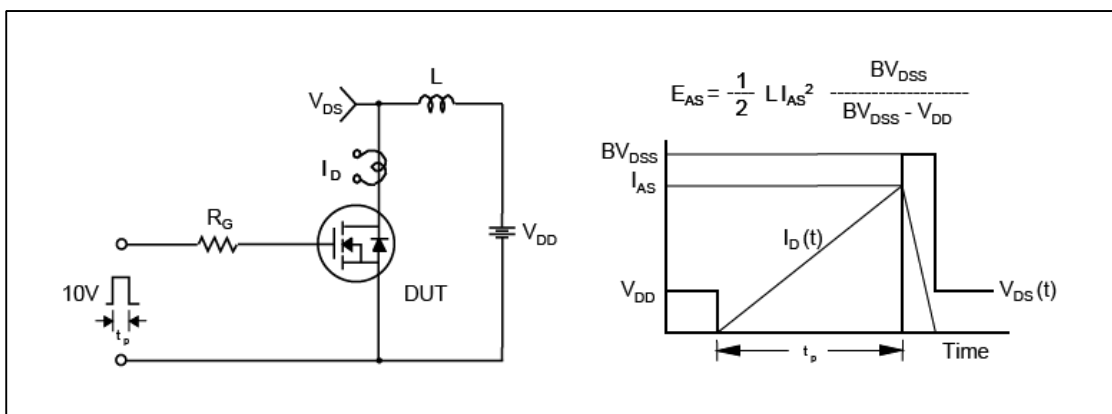

**Fig.14 Unclamped Inductive Switching Test Circuit & Waveform**

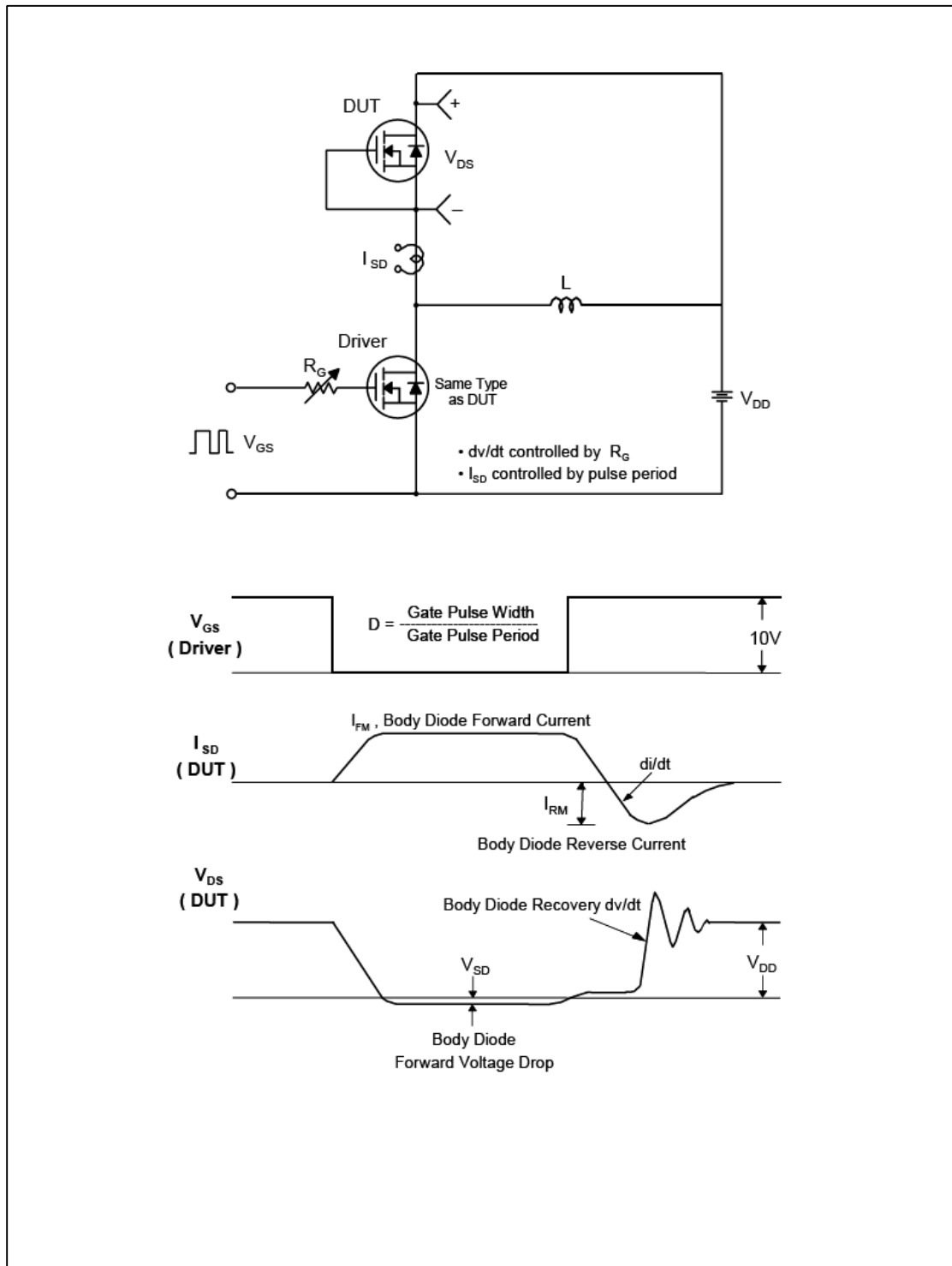

**Fig.15 Peak Diode Recovery  $dv/dt$  Test Circuit & Waveform**

**TO-220F Package Dimension**

