

TGL2201-SM

Wideband Dual Stage VPIN Limiter

Applications

- LNA Receiver Chain Protection
- Military Radar

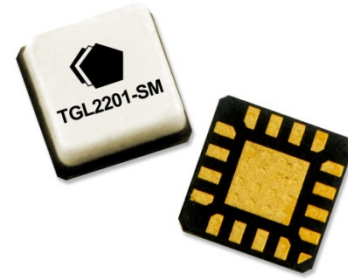

Product Features

- 2-12 GHz Passive, High Isolation Limiter
- Low Loss < 1.0 dB , X-band
- Return Loss > 10 dB
- Flat Leakage < 18 dBm
- Input Power CW Survivability up to 5W
- Integrated DC Block on both input and output
- Package dimensions 3.0 x 3.0 x 1.35 mm

General Description

The TriQuint TGL2201-SM is a packaged dual stage GaAs VPIN Limiter that operates over the 2 to 12 GHz band. Vertical PIN diodes provide the limiting action at high input signal levels and low loss at small signals.

The TGL2201-SM is suitable for a variety of wideband systems such as LNA/receiver protection in radars, phased arrays, and jammers.

Lead-free and RoHS compliant

Functional Block Diagram

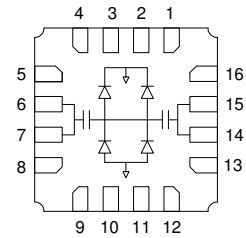

Pin Configuration

Pin #	Symbol
6, 7	RF IN/OUT
14, 15	RF OUT/IN
5, 8, 13, 16	N/C
2, 3, 10, 11	N/C
1, 4, 9, 12	GND

Ordering Information

Part No.	ECCN	Description
TGL2201-SM	EAR99	Wideband VPIN Limiter
TGL2201-SM T/R		Wideband VPIN Limiter T/F

Standard Order Quantity = 100 pieces in a waffle pack

Standard T/R size = 500 pieces on a 7" reel.

TGL220 I-SM

Wideband Dual Stage VPIN Limiter



Specifications

Absolute Maximum Ratings

Parameter	Rating
Storage Temperature	-55 to 150 °C
RF Input Power, CW, 50Ω, T = 25°C	37 dBm
Mounting Temperature	260 °C

Operation of this device outside the parameter ranges given above may cause permanent damage.

Recommended Operating Conditions

Parameter	Min	Typ	Max	Units
Passive – no bias				

Electrical specifications are measured at specified test conditions. Specifications are not guaranteed over all recommended operating conditions.

Electrical Specifications

Test conditions unless otherwise noted: 25°C

Parameter	Conditions	Min	Typical	Max	Units
Operational Frequency Range		2		12	GHz
Insertion Loss			0.5	1.0	dB
Input Return Loss		10	12		dB
Output Return Loss		10	12		dB
Output Power	Input Power = 27dBm		+18		dBm

Typical Performance

Insertion Loss vs. Frequency vs. Temperature

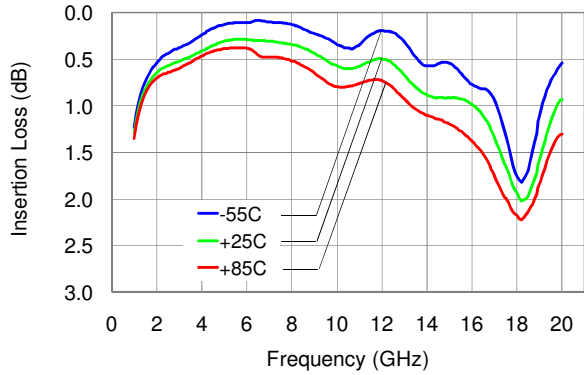

Return Loss vs. Frequency vs. Temperature

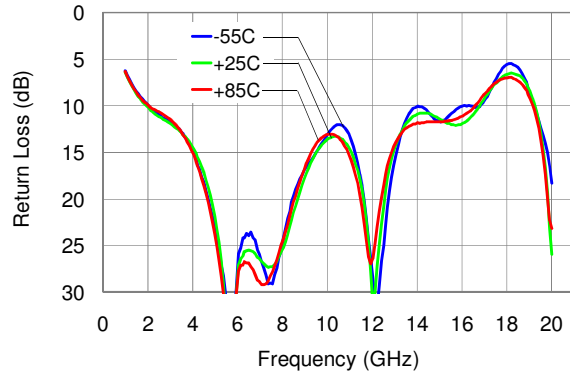

Output Power vs. Input Power vs. Temperature

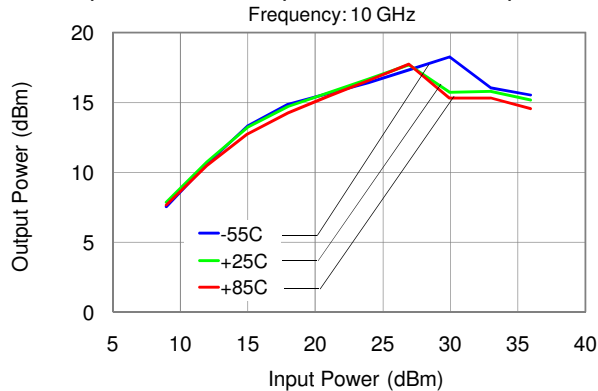

TGL220 I-SM

Wideband Dual Stage VPIN Limiter

Application Circuit

Schematic

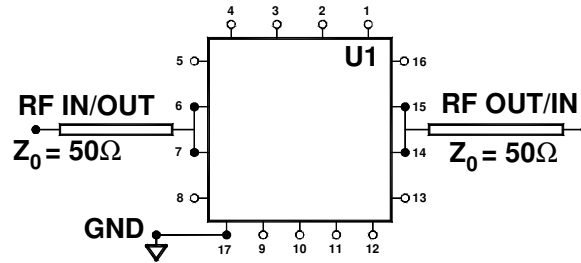

Notes:

1. A heatsink is recommended for high power operation (RF input > 1 W).

TGL220 I-SM

Wideband Dual Stage VPIN Limiter

Pin Description

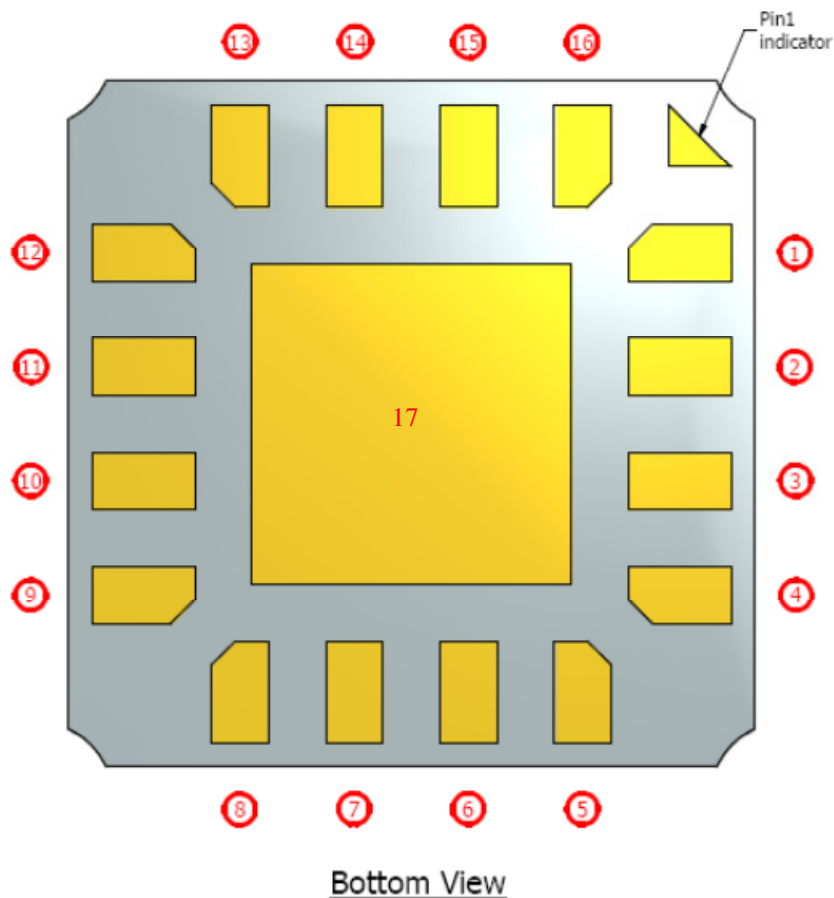

Pin	Symbol	Description
6, 7	RF IN/OUT	Input or output, matched to 50 ohms
5, 8, 13, 16	N/C	No internal connection; should be left open on PCB
14, 15	RF OUT/IN	Output or input, matched to 50 ohms
2, 3, 10, 11,	N/C	No internal connection; may be grounded or left open on PCB
1, 4, 9, 12	GND	Pins 1,4,9, and 12 connected to 17 (backside paddle) inside package.
17	GND	On PCB, multiple vias should be employed under 17 to minimize inductance and thermal resistance; see page 8 for suggested mounting configuration.

TGL2201-SM

Wideband Dual Stage VPIN Limiter

Applications Information

PC Board Layout

Top RF layer is 0.008" thick Rogers RO4003, $\epsilon_r = 3.55$. Metal layers are 1-oz copper. Microstrip 50 Ω line width is .0174". The microstrip line tapers to a 0.014" width at the connector interface. This PCB is designed for the Southwest Microwave end launch connector 1092-01A-5.

The pad pattern shown has been developed and tested for optimized assembly at TriQuint Semiconductor. The PCB land pattern has been developed to accommodate lead and package tolerances. Since surface mount processes vary from company to company, careful process development is recommended.

For further technical information, refer to the [TGL2201-SM](#) Product Information page.

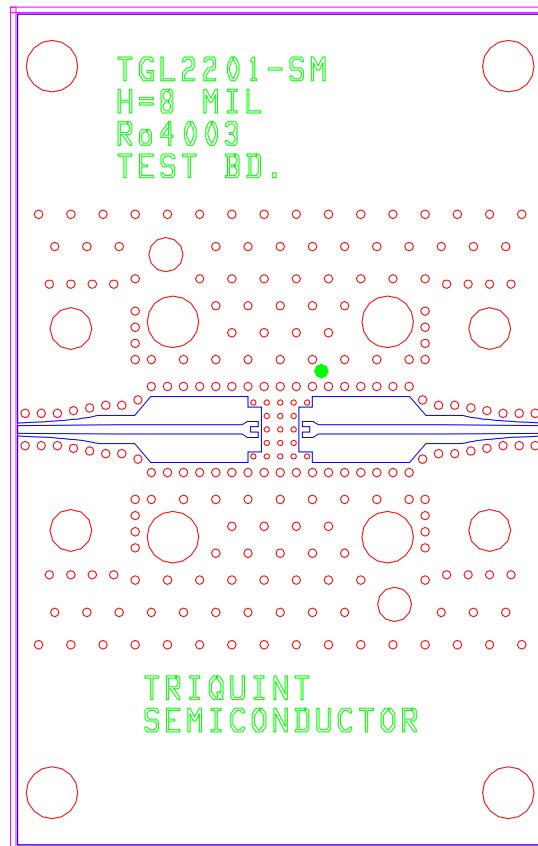

TGL2201-SM

Wideband Dual Stage VPIN Limiter



Mechanical Information

Package Information and Dimensions (Units:Millimeters)

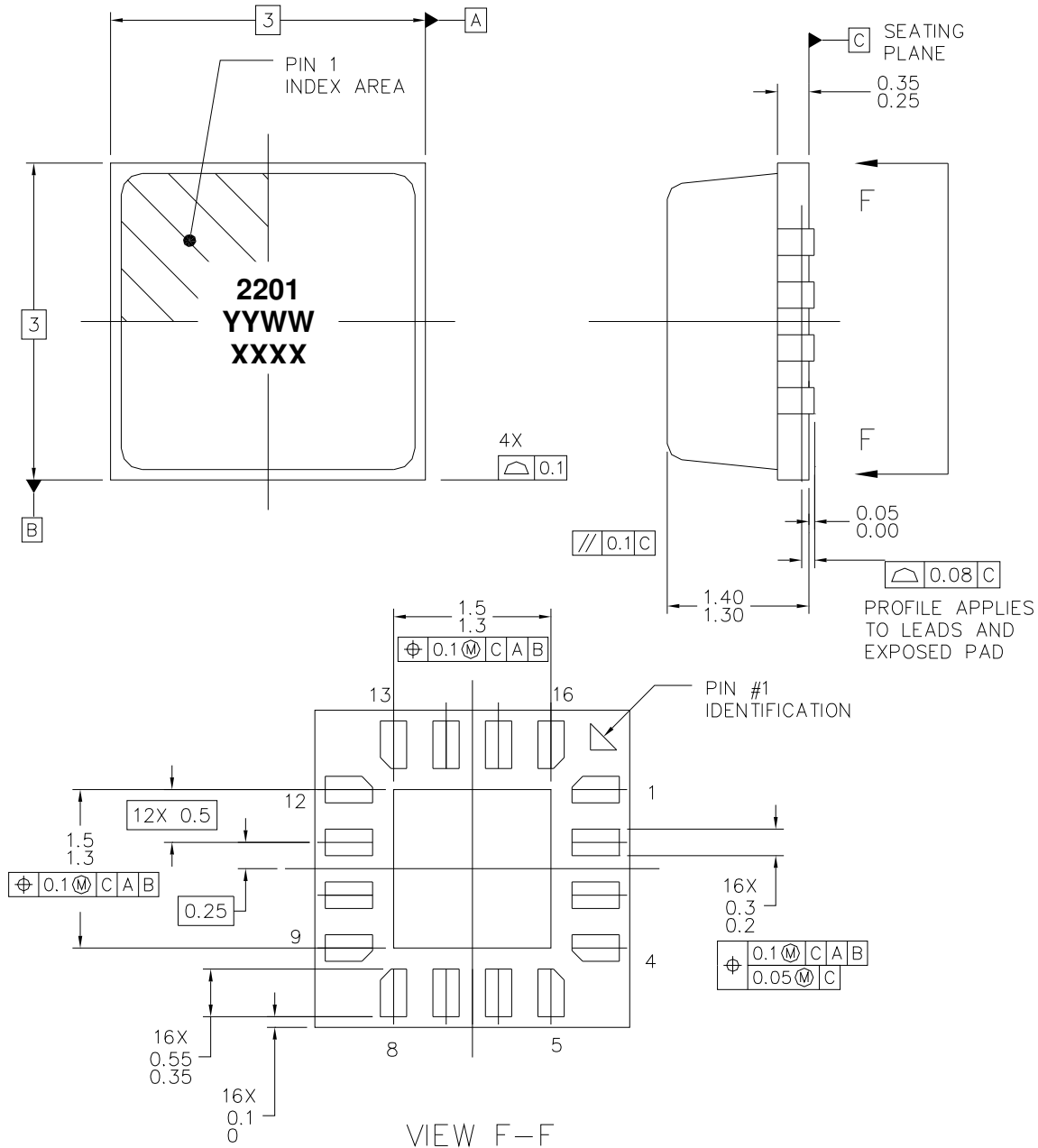

This package is lead-free/RoHS-compliant. The package base is Aluminum Nitride and the plating material on the leads is gold over nickel (Au-Ni). This package is compatible with both lead free and tin-lead soldering processes. The lid is plastic.

The TGL2201-SM will be marked with the “2201” designator and a lot code marked below the part designator. The “YY” represents the last two digits of the year the part was manufactured, the “WW” is the work week, and the “XXXX” is an auto-generated number.

TGL220 I-SM

Wideband Dual Stage VPIN Limiter

Mechanical Information (cont.)

Mounting Configuration

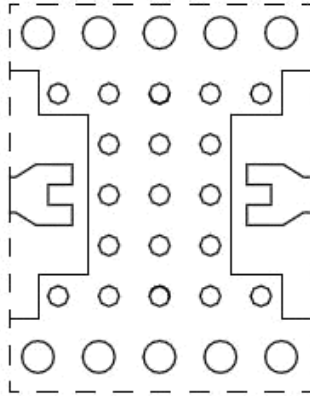

Notes:

1. Ground / thermal vias are critical for the proper performance of this device. Vias should use a .35mm (#80 / .0135") diameter drill and have a final plated thru diameter of 0.25 mm (.010").
2. Add as much copper as possible to inner and outer layers near the part to ensure optimal thermal performance.
3. For further technical information, refer to the [TGL2201-SM](#) Product Information page.

TGL220 I-SM

Wideband Dual Stage VPIN Limiter

Tape and Reel Information

Tape and reel specifications for this part are also available on the TriQuint website in the “Application Notes” section.
Standard T/R size = 500 pieces on a 7” reel.

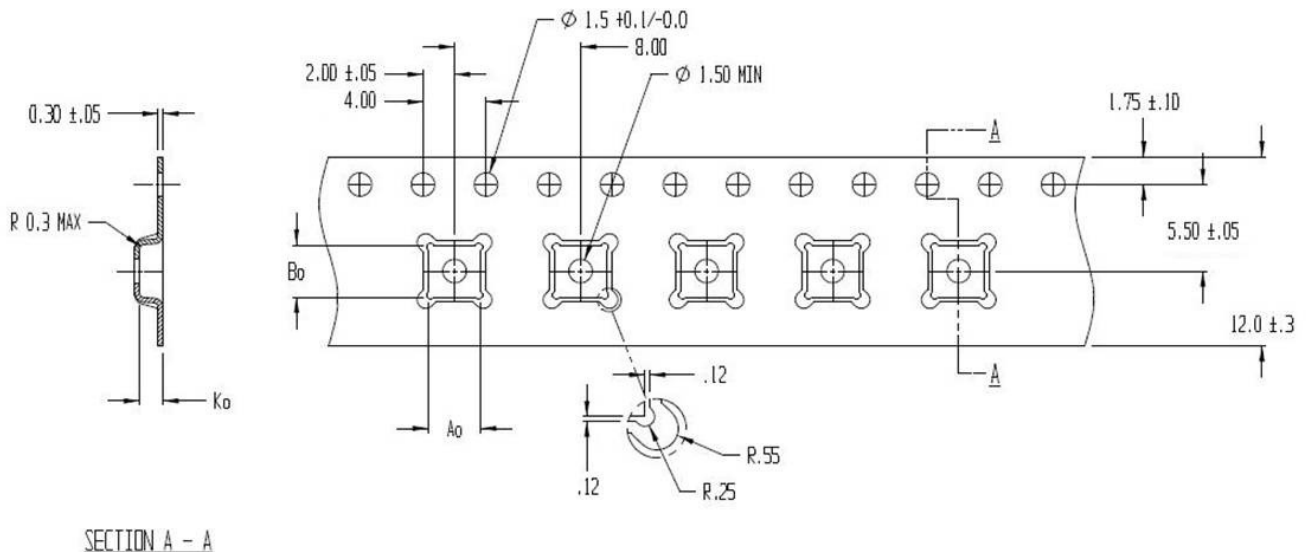

Part	Feature	Symbol	Size (in)	Size (mm)
Cavity	Length	A0	0.130	3.30
	Width	B0	0.130	3.30
	Depth	K0	0.059	1.50

Product Compliance Information

ESD Information



Caution! ESD-Sensitive Device

ESD Rating: Class 1B
Value: ≥ 500 V and < 1000 V
Test: Human Body Model (HBM)
Standard: JEDEC Standard JESD22-A114

MSL Rating

Level 3 at $+260$ °C convection reflow
The part is rated Moisture Sensitivity Level 3 at 260°C per JEDEC standard IPC/JEDEC J-STD-020.

Solderability

Compatible with the latest version of J-STD-020, Lead free solder, 260°

This part is compliant with EU 2002/95/EC RoHS directive (Restrictions on the Use of Certain Hazardous Substances in Electrical and Electronic Equipment).

This product also has the following attributes:

- Lead Free
- Halogen Free (Chlorine, Bromine)
- Antimony Free
- TBBP-A ($\text{C}_{15}\text{H}_{12}\text{Br}_4\text{O}_2$) Free
- PFOS Free
- SVHC Free

Recommended Soldering Temperature Profile

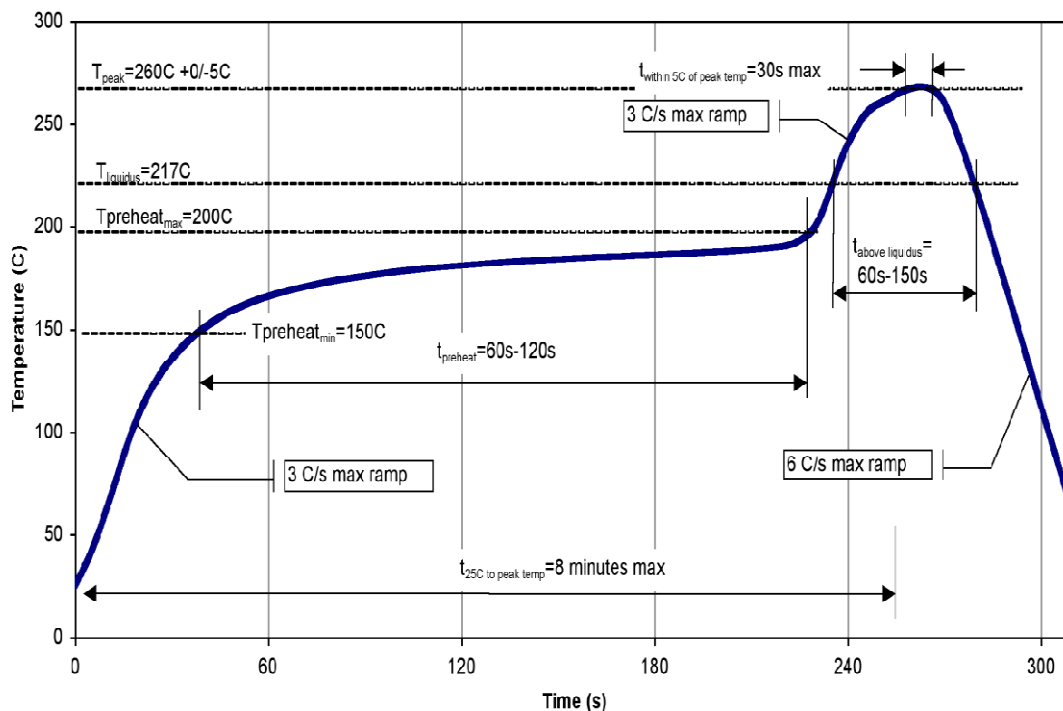

TGL220 I-SM

Wideband Dual Stage VPIN Limiter



Contact Information

For the latest specifications, additional product information, worldwide sales and distribution locations, and information about TriQuint:

Web: www.triquint.com
Email: info-sales@tqs.com

Tel: +1.972.994.8465
Fax: +1.972.664.8504

For technical questions and application information:

Email: info-mmw@tqs.com

Important Notice

The information contained herein is believed to be reliable. TriQuint makes no warranties regarding the information contained herein. TriQuint assumes no responsibility or liability whatsoever for any of the information contained herein. TriQuint assumes no responsibility or liability whatsoever for the use of the information contained herein. The information contained herein is provided "AS IS, WHERE IS" and with all faults, and the entire risk associated with such information is entirely with the user. All information contained herein is subject to change without notice. Customers should obtain and verify the latest relevant information before placing orders for TriQuint products. The information contained herein or any use of such information does not grant, explicitly or implicitly, to any party any patent rights, licenses, or any other intellectual property rights, whether with regard to such information itself or anything described by such information.

TriQuint products are not warranted or authorized for use as critical components in medical, life-saving, or life-sustaining applications, or other applications where a failure would reasonably be expected to cause severe personal injury or death.

Copyright © 2012 TriQuint Semiconductor, Inc. All rights reserved.