

#### General Description

The UD50N03 is the highest performance trench N-ch MOSFETs with extreme high cell density, which provide excellent RDSON and gate charge for most of the synchronous buck converter applications.

The UD50N03 meet the RoHS and Green Product requirement 100% EAS guaranteed with full function reliability approved.

#### Features

- Advanced high cell density Trench technology
- Super Low Gate Charge
- Excellent CdV/dt effect decline
- 100% EAS Guaranteed
- Green Device Available

#### Absolute Maximum Ratings

Symbol	Parameter	Rating	Units
$V_{DS}$	Drain-Source Voltage	30	V
$V_{GS}$	Gate-Source Voltage	$\pm 20$	V
$I_D@T_C=25^\circ C$	Continuous Drain Current, $V_{GS} @ 10V^1$	51	A
$I_D@T_C=100^\circ C$	Continuous Drain Current, $V_{GS} @ 10V^1$	30	A
$I_D@T_A=25^\circ C$	Continuous Drain Current, $V_{GS} @ 10V^1$	11	A
$I_D@T_A=70^\circ C$	Continuous Drain Current, $V_{GS} @ 10V^1$	9	A
$I_{DM}$	Pulsed Drain Current <sup>2</sup>	112	A
EAS	Single Pulse Avalanche Energy <sup>3</sup>	53	mJ
$I_{AS}$	Avalanche Current	22	A
$P_D@T_C=25^\circ C$	Total Power Dissipation <sup>4</sup>	37.5	W
$P_D@T_A=25^\circ C$	Total Power Dissipation <sup>4</sup>	2.42	W
$T_{STG}$	Storage Temperature Range	-55 to 175	$^\circ C$
$T_J$	Operating Junction Temperature Range	-55 to 175	$^\circ C$

#### Thermal Data

Symbol	Parameter	Typ.	Max.	Unit
$R_{\theta JA}$	Thermal Resistance Junction-Ambient <sup>1</sup>	---	62	$^\circ C/W$
$R_{\theta JC}$	Thermal Resistance Junction-Case <sup>1</sup>	---	4	$^\circ C/W$

#### Product Summary

BVDSS	RDSON	ID
30V	12m $\Omega$	51A

#### Applications

- High Frequency Point-of-Load Synchronous Buck Converter for MB/NB/UMPC/VGA
- Networking DC-DC Power System
- Load Switch

#### TO252 Pin Configuration

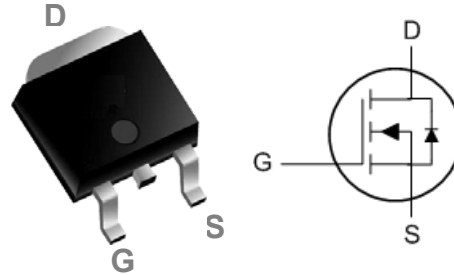

#### Electrical Characteristics ( $T_J=25\text{ }^\circ\text{C}$ , unless otherwise noted)

Symbol	Parameter	Conditions	Min.	Typ.	Max.	Unit
$BV_{DSS}$	Drain-Source Breakdown Voltage	$V_{GS}=0V, I_D=250\mu A$	30	---	---	V
$\Delta BV_{DSS}/\Delta T_J$	BVDSS Temperature Coefficient	Reference to $25\text{ }^\circ\text{C}$ , $I_D=1mA$	---	0.0193	---	V/ $^\circ\text{C}$
$R_{DS(ON)}$	Static Drain-Source On-Resistance <sup>2</sup>	$V_{GS}=10V, I_D=30A$	---	10	12	m $\Omega$
		$V_{GS}=4.5V, I_D=15A$	---	15	18	
$V_{GS(th)}$	Gate Threshold Voltage	$V_{GS}=V_{DS}, I_D=250\mu A$	1.2	1.5	2.5	V
$\Delta V_{GS(th)}$	$V_{GS(th)}$ Temperature Coefficient		---	-3.97	---	mV/ $^\circ\text{C}$
$I_{DSS}$	Drain-Source Leakage Current	$V_{DS}=24V, V_{GS}=0V, T_J=25\text{ }^\circ\text{C}$	---	---	1	$\mu A$
		$V_{DS}=24V, V_{GS}=0V, T_J=55\text{ }^\circ\text{C}$	---	---	5	
$I_{GSS}$	Gate-Source Leakage Current	$V_{GS}=\pm 20V, V_{DS}=0V$	---	---	$\pm 100$	nA
gfs	Forward Transconductance	$V_{DS}=5V, I_D=30A$	---	34	---	S
$R_g$	Gate Resistance	$V_{DS}=0V, V_{GS}=0V, f=1MHz$	---	1.8	3.6	$\Omega$
$Q_g$	Total Gate Charge (4.5V)	$V_{DS}=15V, V_{GS}=4.5V, I_D=15A$	---	9.8	13.7	nC
$Q_{gs}$	Gate-Source Charge		---	4.2	5.88	
$Q_{gd}$	Gate-Drain Charge		---	3.6	5.0	
$T_{d(on)}$	Turn-On Delay Time	$V_{DD}=15V, V_{GS}=10V, R_G=3.3\Omega$	---	4	8.0	ns
$T_r$	Rise Time	$I_D=15A$	---	8	14	
$T_{d(off)}$	Turn-Off Delay Time		---	31	62	
$T_f$	Fall Time		---	4	8	
$C_{iss}$	Input Capacitance	$V_{DS}=15V, V_{GS}=0V, f=1MHz$	---	940	1316	pF
$C_{oss}$	Output Capacitance		---	131	183	
$C_{rss}$	Reverse Transfer Capacitance		---	109	153	

#### Guaranteed Avalanche Characteristics

Symbol	Parameter	Conditions	Min.	Typ.	Max.	Unit
EAS	Single Pulse Avalanche Energy <sup>5</sup>	$V_{DD}=25V, L=0.1mH, I_{AS}=15A$	24.6	---	---	mJ

#### Diode Characteristics

Symbol	Parameter	Conditions	Min.	Typ.	Max.	Unit
$I_S$	Continuous Source Current <sup>1,6</sup>	$V_G=V_D=0V$ , Force Current	---	---	43	A
$I_{SM}$	Pulsed Source Current <sup>2,6</sup>		---	---	112	A
$V_{SD}$	Diode Forward Voltage <sup>2</sup>	$V_{GS}=0V, I_S=1A, T_J=25\text{ }^\circ\text{C}$	---	---	1	V
$t_{rr}$	Reverse Recovery Time	$I_F=30A, dI/dt=100A/\mu s, T_J=25\text{ }^\circ\text{C}$	---	8.5	---	nS
$Q_{rr}$	Reverse Recovery Charge		---	2.2	---	nC

Note :

- 1.The data tested by surface mounted on a 1 inch<sup>2</sup>FR-4 board with 2OZ copper.
- 2.The data tested by pulsed , pulse width  $\leq 300\mu s$ , duty cycle  $\leq 2\%$
- 3.The EAS data shows Max. rating . The test condition is  $V_{DD}=25V, V_{GS}=10V, L=0.1mH, I_{AS}=22A$
- 4.The power dissipation is limited by  $175\text{ }^\circ\text{C}$  junction temperature
- 5.The Min. value is 100% EAS tested guarantee.
- 6.The data is theoretically the same as  $I_D$  and  $I_{DM}$ , in real applications , should be limited by total power dissipation.

#### Typical Characteristics

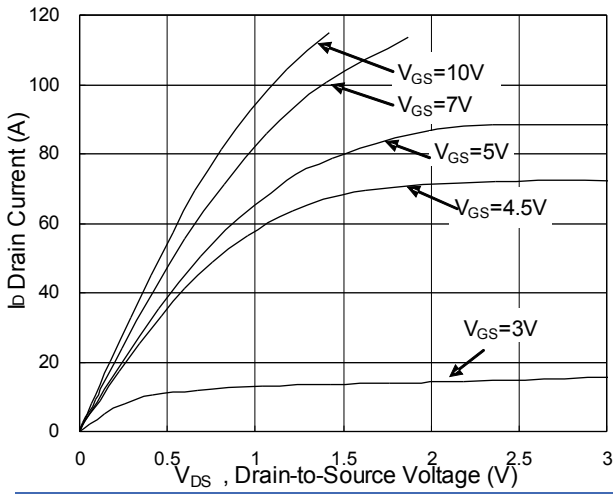

Fig.1 Typical Output Characteristics

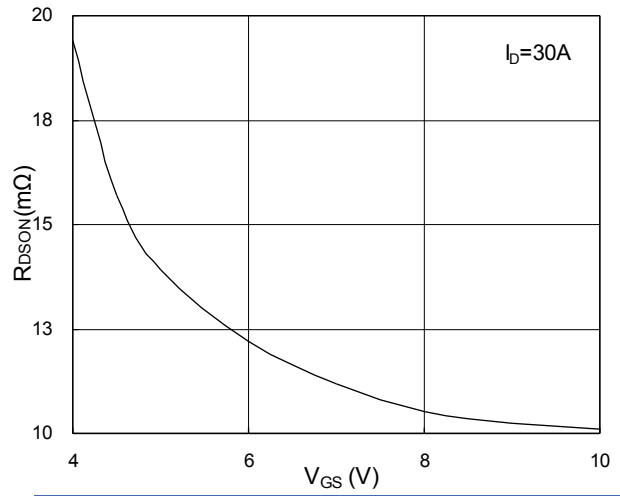

Fig.2 On-Resistance vs. Gate-Source

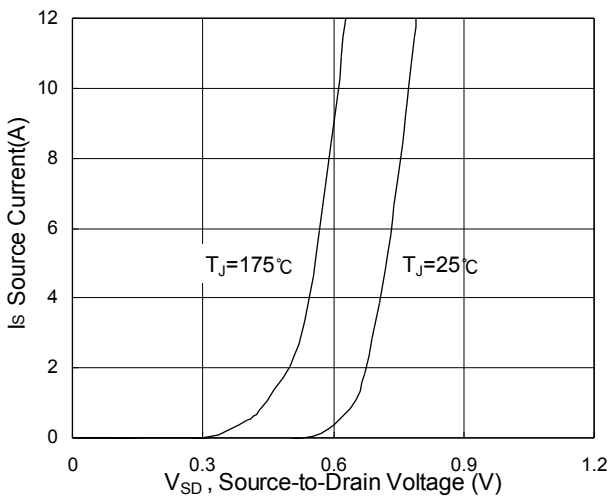

Fig.3 Forward Characteristics of Reverse

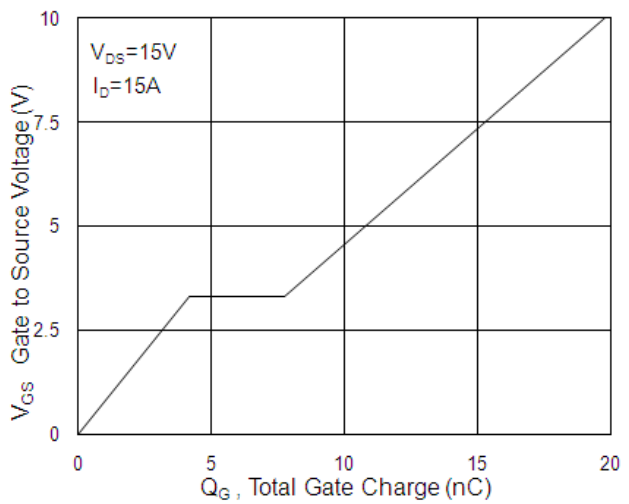

Fig.4 Gate-Charge Characteristics

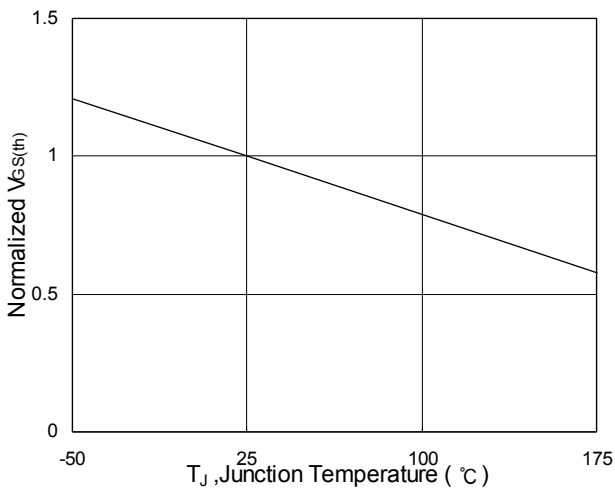

Fig.5 Normalized V<sub>GS(th)</sub> vs. T<sub>J</sub>

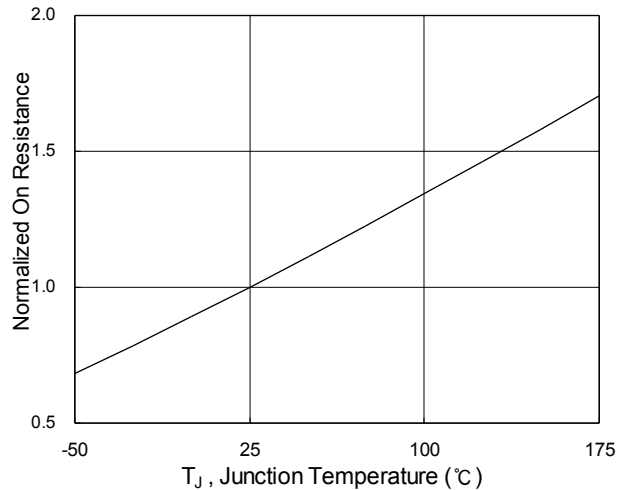

Fig.6 Normalized R<sub>DSON</sub> vs. T<sub>J</sub>

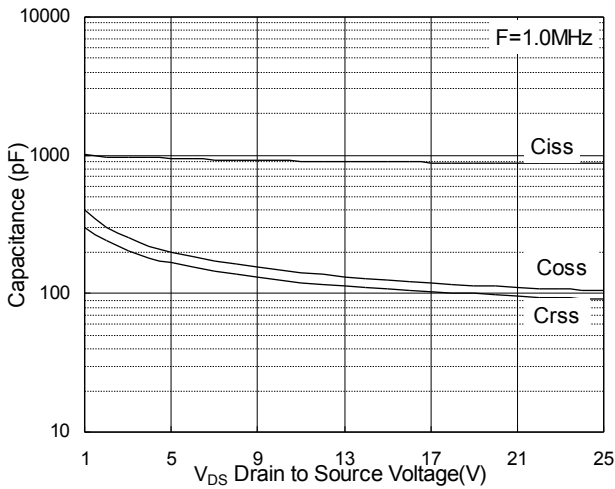

Fig.7 Capacitance

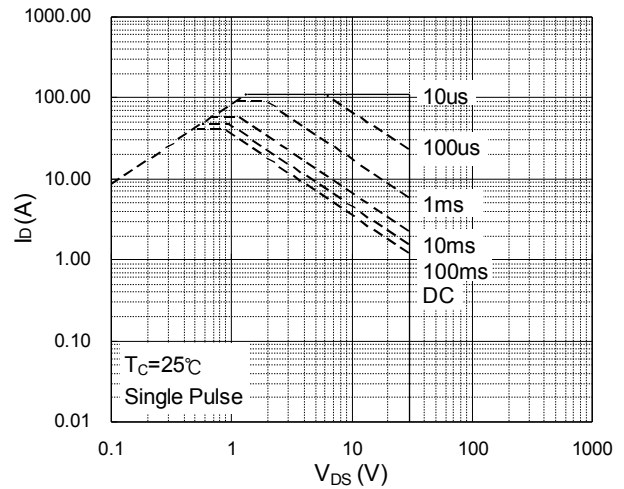

Fig.8 Safe Operating Area

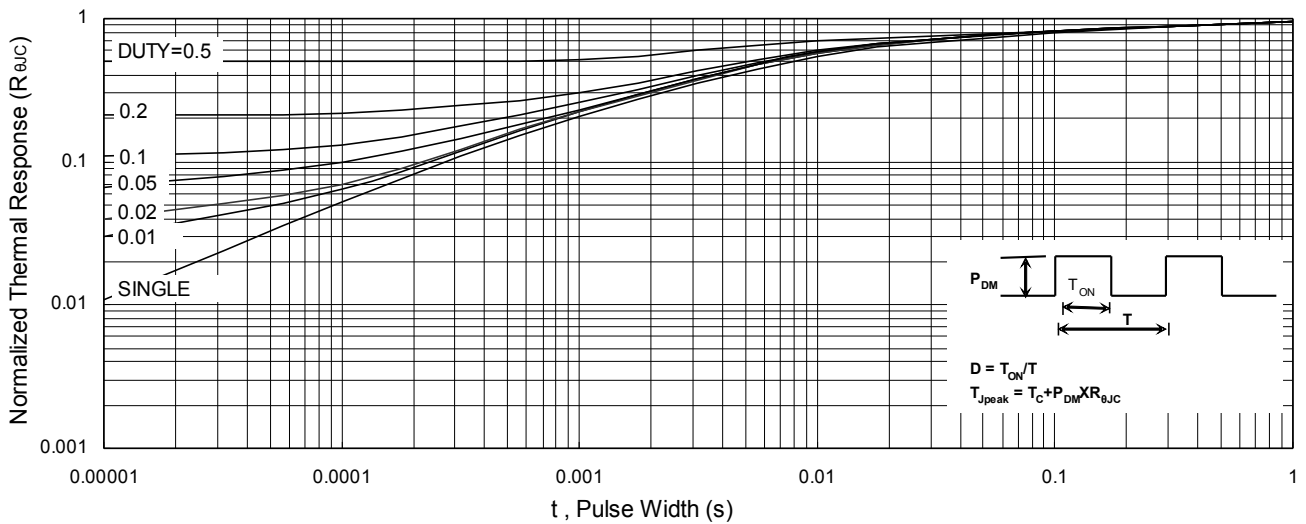

Fig.9 Normalized Maximum Transient Thermal Impedance

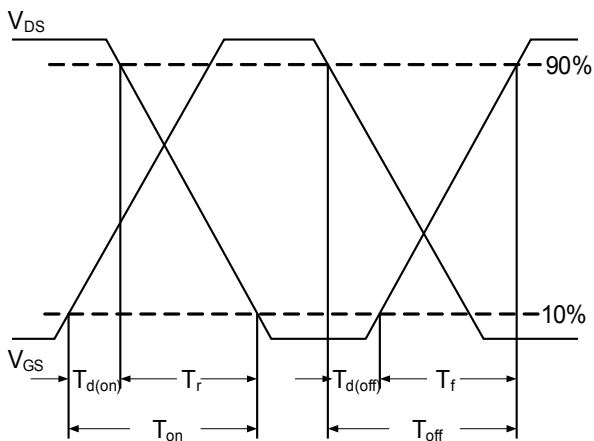

Fig.10 Switching Time Waveform

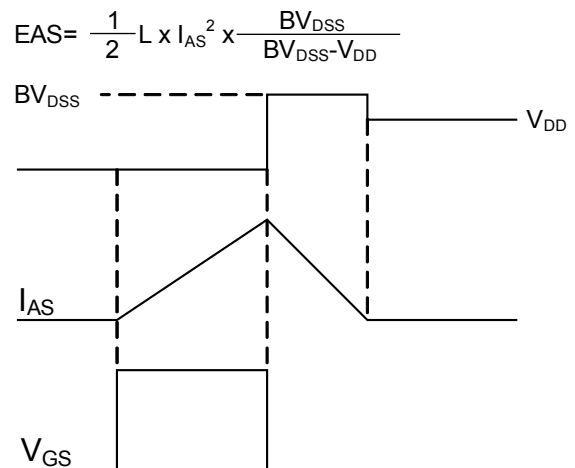

Fig.11 Unclamped Inductive Switching Waveform