

# SEMiX 553GD128Dc

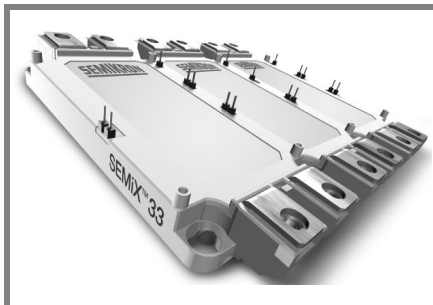

SEMiX® 33c

## SPT IGBT Modules

### SEMiX 553GD128Dc

Preliminary Data

#### Features

- Homogeneous Si
- SPT = Soft-Punch-Through technology
- $V_{CE(sat)}$  with positive temperature coefficient
- High short circuit capability

#### Typical Applications

- AC inverter drives
- UPS
- Electronic welders up to 20 kHz

Absolute Maximum Ratings		$T_{case} = 25^{\circ}C$ , unless otherwise specified		
Symbol	Conditions	Values	Units	
<b>IGBT</b>				
$V_{CES}$	$T_j = 25^{\circ}C$	1200	V	
$I_C$	$T_j = 150^{\circ}C$	$T_{case} = 25^{\circ}C$	535	A
		$T_{case} = 80^{\circ}C$	380	A
$I_{CRM}$	$I_{CRM} = 2 \times I_{Cnom}$	600	A	
$V_{GES}$		$\pm 20$	V	
$t_{psc}$	$V_{CC} = 600 V$ ; $V_{GE} \leq 20 V$ ; $T_j = 125^{\circ}C$ $V_{CES} < 1200 V$	10	$\mu s$	
<b>Inverse Diode</b>				
$I_F$	$T_j = 150^{\circ}C$	$T_{case} = 25^{\circ}C$	420	A
		$T_{case} = 80^{\circ}C$	285	A
$I_{FRM}$	$I_{FRM} = 2 \times I_{Fnom}$	600	A	
$I_{FSM}$	$t_p = 10 ms$ ; sin.	$T_j = 25^{\circ}C$	2300	A
<b>Module</b>				
$I_{t(RMS)}$		600	A	
$T_{vj}$		-40 ... +150	$^{\circ}C$	
$T_{stg}$		-40 ... +125	$^{\circ}C$	
$V_{isol}$	AC, 1 min.	4000	V	

Characteristics		$T_{case} = 25^{\circ}C$ , unless otherwise specified				
Symbol	Conditions	min.	typ.	max.	Units	
<b>IGBT</b>						
$V_{GE(th)}$	$V_{GE} = V_{CE}$ , $I_C = 12 mA$	4,5	5	6,5	V	
$I_{CES}$	$V_{GE} = 0 V$ , $V_{CE} = V_{CES}$	$T_j = 25^{\circ}C$			0,3	mA
			$T_j = 125^{\circ}C$	1	1,15	V
$V_{CE0}$		$T_j = 25^{\circ}C$	0,9	1,05	V	
		$T_j = 125^{\circ}C$	3	4	$m\Omega$	
$r_{CE}$	$V_{GE} = 15 V$	$T_j = 25^{\circ}C$	4	5	$m\Omega$	
		$T_j = 125^{\circ}C$	1,9	2,35	V	
$V_{CE(sat)}$	$I_{Cnom} = 300 A$ , $V_{GE} = 15 V$	$T_j = 25^{\circ}C_{chiplev.}$	2,1	2,55	V	
$C_{ies}$	$V_{CE} = 25$ , $V_{GE} = 0 V$	$f = 1 MHz$			28,3	nF
$C_{oes}$					1,9	nF
$C_{res}$					1,2	nF
$Q_G$	$V_{GE} = -8 V \dots +15 V$			2900	nC	
$t_{d(on)}$	$R_{Gon} = 3 \Omega$	$V_{CC} = 600V$ $I_{Cnom} = 300A$ $T_j = 125^{\circ}C$			185	ns
$t_r$					65	ns
$E_{on}$					27	mJ
$t_{d(off)}$	$R_{Goff} = 3 \Omega$	$T_j = 125^{\circ}C$			635	ns
$t_f$					80	ns
$E_{off}$					33	mJ
$R_{th(j-c)}$	per IGBT			0,061	K/W	

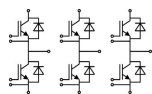

GD

# SEMiX 553GD128Dc

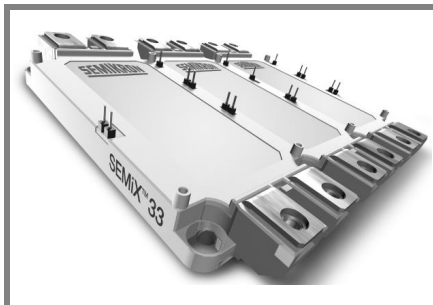

**SEMiX® 33c**

## SPT IGBT Modules

### SEMiX 553GD128Dc

#### Preliminary Data

#### Features

- Homogeneous Si
- SPT = Soft-Punch-Through technology
- $V_{CE(sat)}$  with positive temperature coefficient
- High short circuit capability

#### Typical Applications

- AC inverter drives
- UPS
- Electronic welders up to 20 kHz

Characteristics			min.	typ.	max.	Units
Symbol	Conditions					
<b>Inverse Diode</b>						
$V_F = V_{EC}$	$I_{Fnom} = 300 \text{ A}; V_{GE} = 0 \text{ V}$	$T_j = 25 \text{ }^\circ\text{C}_{chiplev.}$		2	2,5	V
		$T_j = 125 \text{ }^\circ\text{C}_{chiplev.}$		1,8	2,3	V
$V_{F0}$		$T_j = 25 \text{ }^\circ\text{C}$		1,1	1,45	V
		$T_j = 125 \text{ }^\circ\text{C}$		0,85	1,2	V
$r_F$		$T_j = 25 \text{ }^\circ\text{C}$		3	3,5	mΩ
		$T_j = 125 \text{ }^\circ\text{C}$		3,2	3,7	mΩ
$I_{RRM}$	$I_{Fnom} = 300 \text{ A}$	$T_j = 125 \text{ }^\circ\text{C}$		325		A
$Q_{rr}$	$di/dt = 5400 \text{ A}/\mu\text{s}$			46		μC
$E_{rr}$	$V_{GE} = -15 \text{ V}; V_{CC} = 600 \text{ V}$			17		mJ
$R_{th(j-c)D}$	per diode				0,11	K/W
<b>Module</b>						
$L_{CE}$				20		nH
$R_{CC'+EE'}$	res., terminal-chip	$T_{case} = 25 \text{ }^\circ\text{C}$		0,7		mΩ
		$T_{case} = 125 \text{ }^\circ\text{C}$		1		mΩ
$R_{th(c-s)}$	per module			0,014		K/W
$M_s$	to heat sink (M5)			3	5	Nm
$M_t$	to terminals (M6)			2,5	5	Nm
w					900	g
<b>Temperature sensor</b>						
$R_{100}$	$T_c = 100 \text{ }^\circ\text{C}$ ( $R_{25} = 5 \text{ k}\Omega$ )			0,493±5%		kΩ
$B_{100/125}$	$R(T) = R_{100} \exp[B_{100/125} (1/T - 1/T_{100})]$ ; $T[\text{K}]; B$			3550±2%		K

This is an electrostatic discharge sensitive device (ESDS), international standard IEC 60747-1, Chapter IX.

This technical information specifies semiconductor devices but promises no characteristics. No warranty or guarantee expressed or implied is made regarding delivery, performance or suitability.

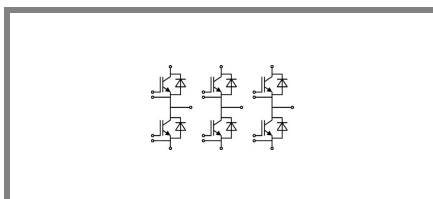

**GD**

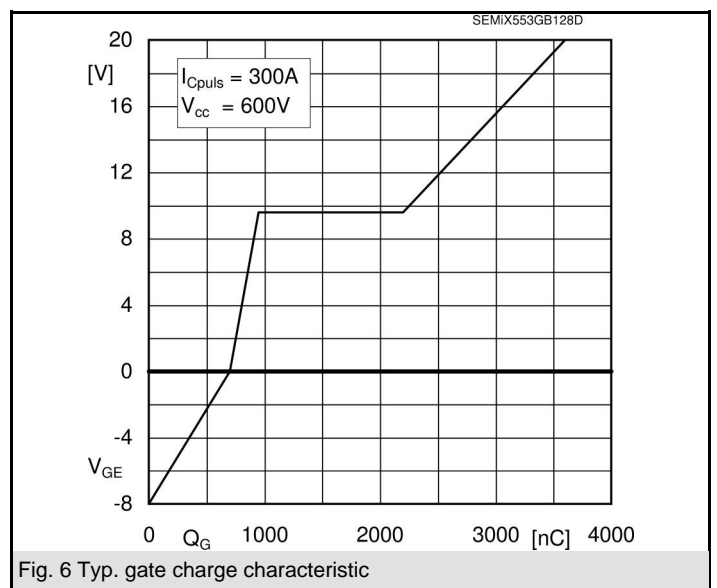
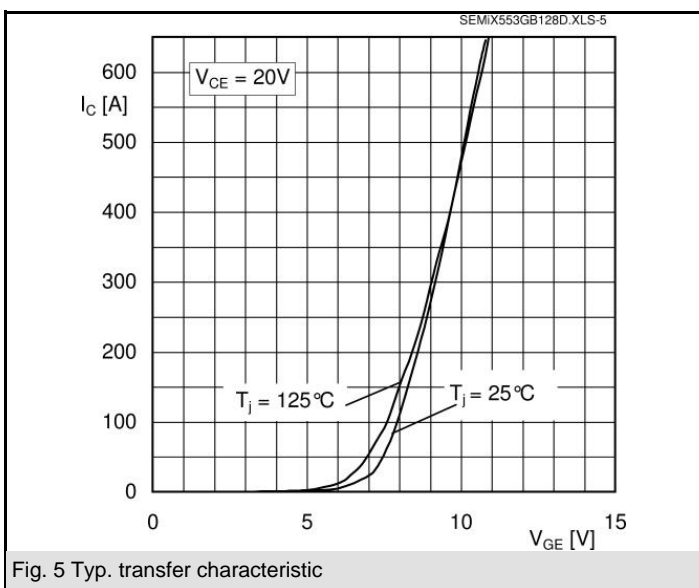
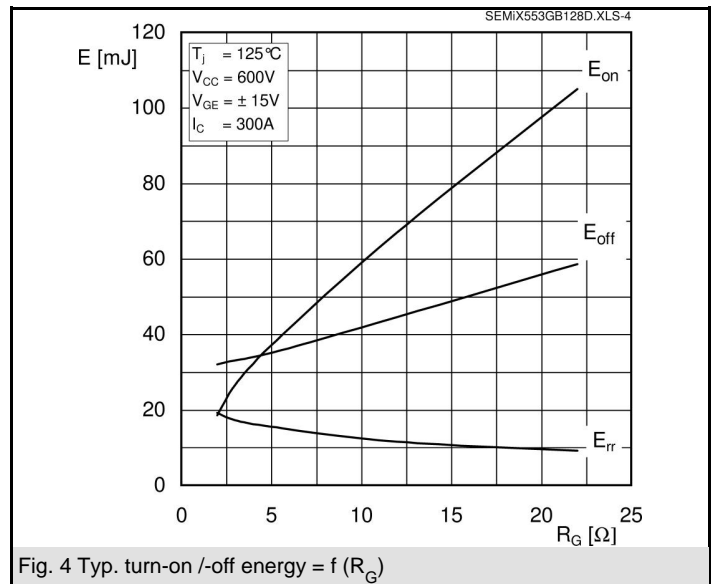
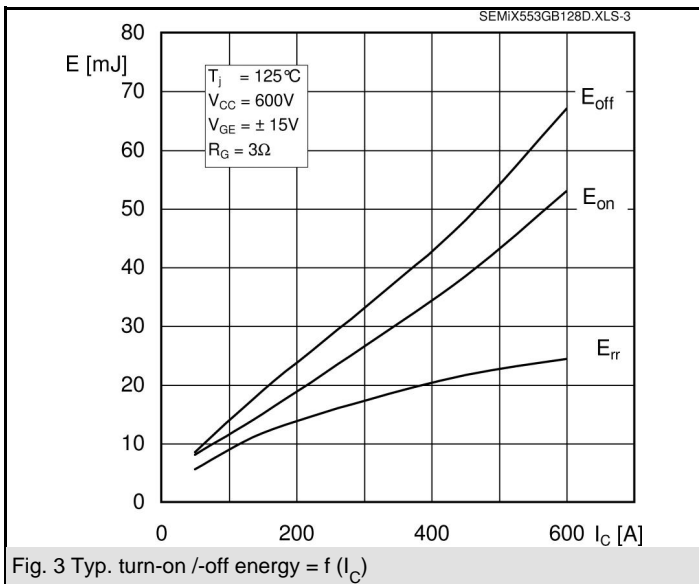
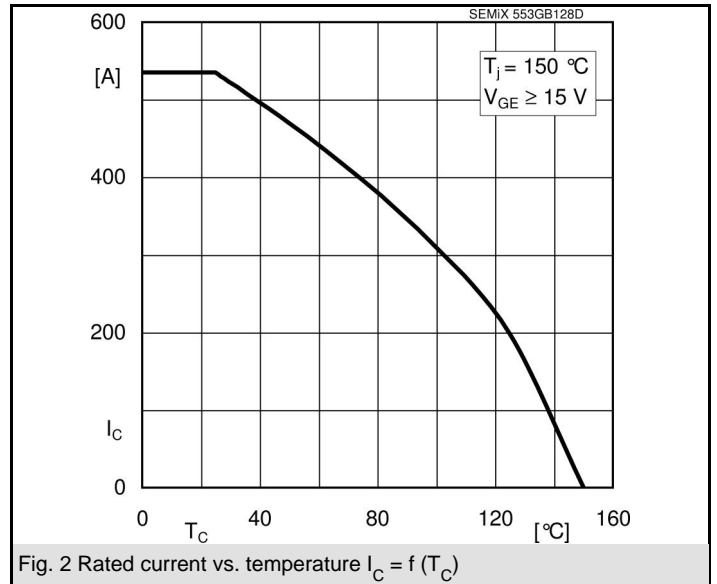
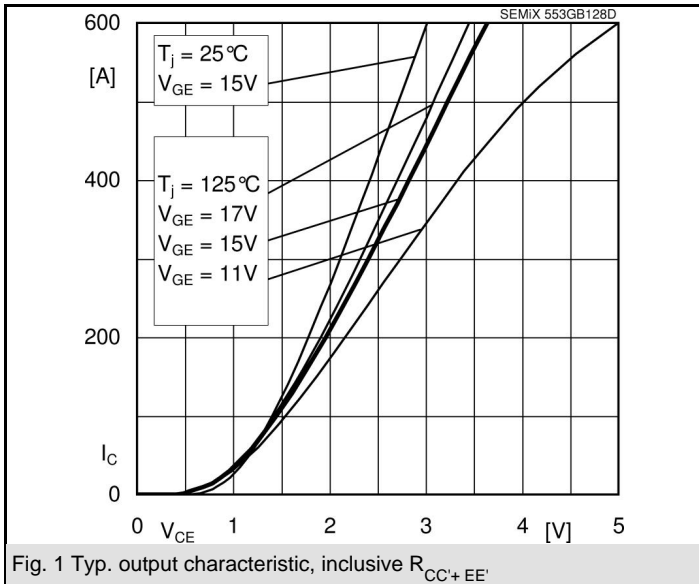

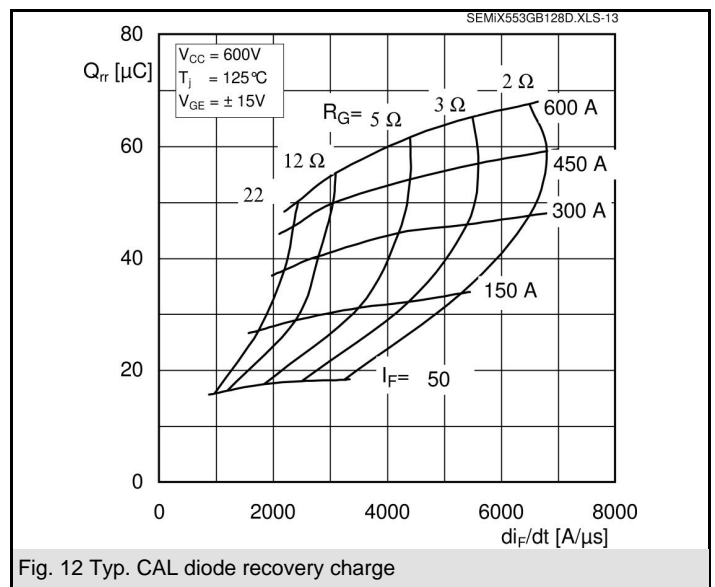
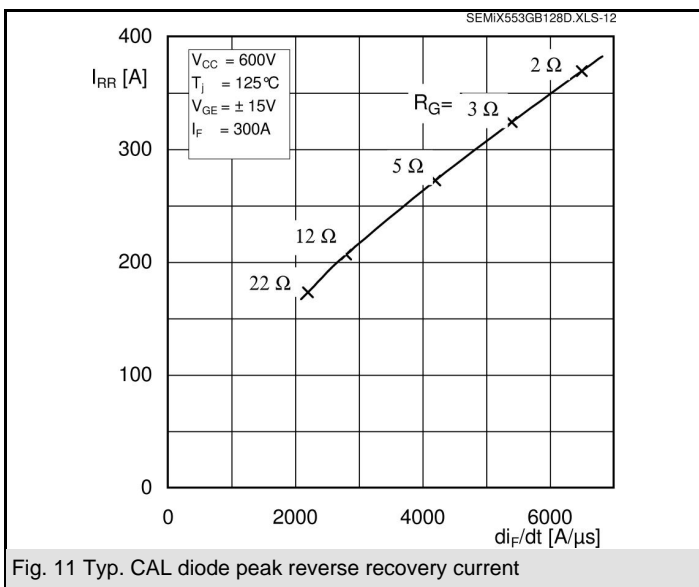
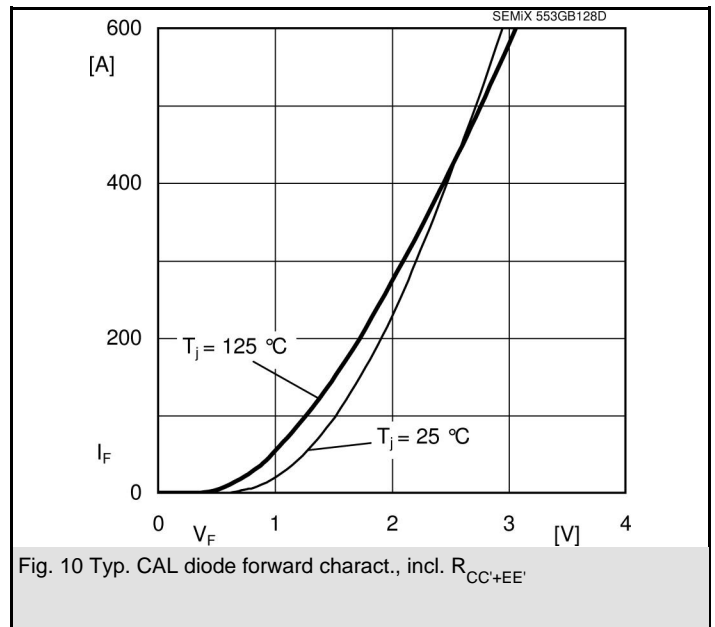
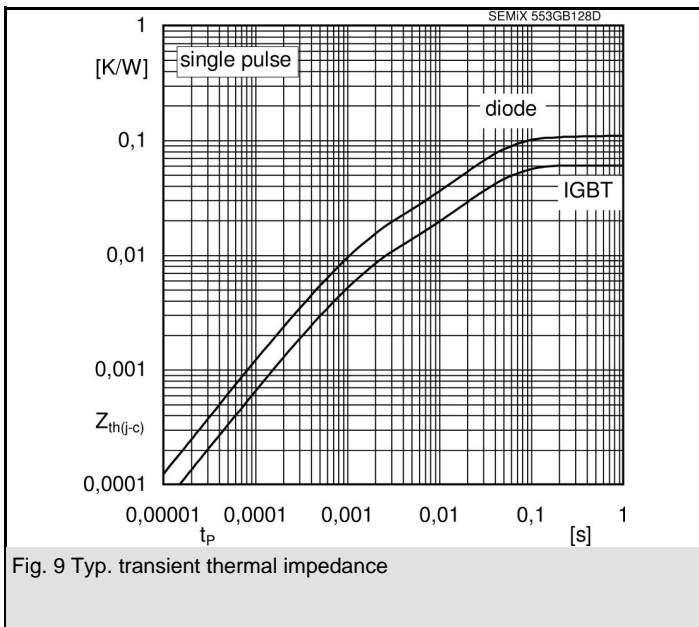
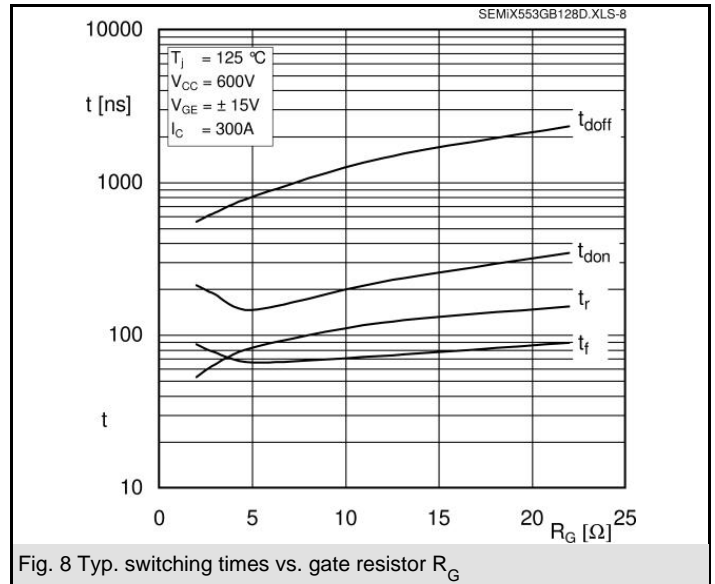
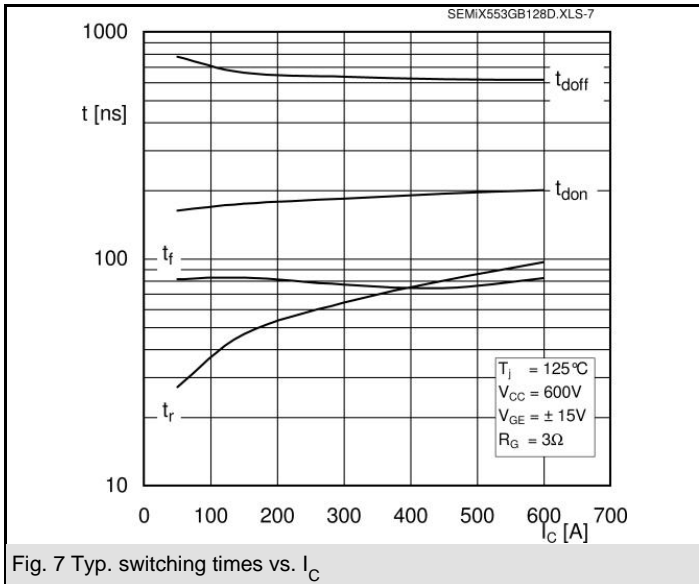

# SEMiX 553GD128Dc

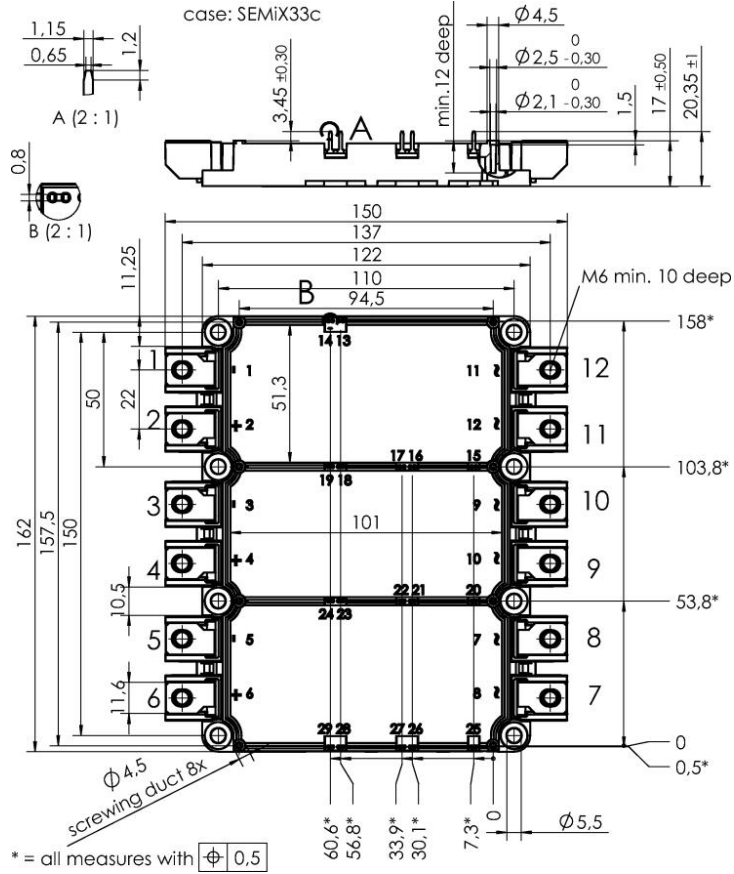

Case SEMiX 33c

