

2N6517

NPN Epitaxial Silicon Transistor

Features

- High Voltage Transistor
- Collector Dissipation: $P_C(\text{max}) = 625\text{mW}$
- Complement to 2N6520
- Suffix “-C” means Center Collector (1. Emitter 2. Collector 3. Base)

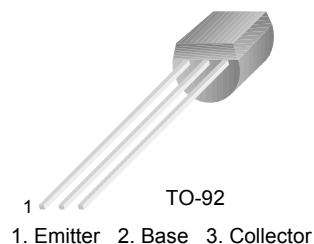

Absolute Maximum Ratings $T_a = 25^\circ\text{C}$ unless otherwise noted

| Symbol | Parameter | Value | Units |
|-----------|-----------------------------|-----------|------------------|
| V_{CBO} | Collector-Base Voltage | 2N6517 | 350 |
| | | 2N6517C | 400 |
| V_{CEO} | Collector-Emitter Voltage | 2N6517 | 350 |
| | | 2N6517C | 400 |
| V_{EBO} | Emitter-Base Voltage | 6 | V |
| I_C | Collector Current | 500 | mA |
| P_C | Collector Power Dissipation | 625 | mW |
| T_J | Junction Temperature | 150 | $^\circ\text{C}$ |
| T_{STG} | Storage Temperature | -55 ~ 150 | $^\circ\text{C}$ |

Electrical Characteristics $T_a = 25^\circ\text{C}$ unless otherwise noted

| Symbol | Parameter | Conditions | Min. | Max. | Units |
|------------|---------------------------------------|--|------|------|-------|
| BV_{CBO} | Collector-Base Breakdown Voltage | 2N6517 $I_C = 100\mu\text{A}, I_E = 0$ | 350 | | V |
| | | 2N6517C $I_C = 100\mu\text{A}, I_E = 0$ | 400 | | V |
| BV_{CEO} | Collector-Emitter Breakdown Voltage * | 2N6517 $I_C = 1\text{mA}, I_B = 0$ | 350 | | V |
| | | 2N6517C $I_C = 1\text{mA}, I_B = 0$ | 400 | | V |
| BV_{EBO} | Emitter-Base Breakdown Voltage | $I_E = 10\mu\text{A}, I_C = 0$ | 6 | | V |
| I_{CBO} | Collector Cut-off Current | $V_{CB} = 250\text{V}, I_E = 0$ | | 50 | nA |
| I_{EBO} | Emitter Cut-off Current | $V_{EB} = 5\text{V}, I_C = 0$ | | 50 | nA |
| h_{FE} | DC Current Gain * | 2N6517/2N6517C $V_{CE} = 10\text{V}, I_C = 1\text{mA}$ | 20 | | |
| | | 2N6517/2N6517C $V_{CE} = 10\text{V}, I_C = 10\text{mA}$ | 30 | | |
| | | 2N6517/2N6517C $V_{CE} = 10\text{V}, I_C = 30\text{mA}$ | 30 | 200 | |
| | | 2N6517/2N6517C $V_{CE} = 10\text{V}, I_C = 50\text{mA}$ | 20 | 200 | |
| | | 2N6517/2N6517C $V_{CE} = 10\text{V}, I_C = 100\text{mA}$ | 15 | | |
| | | 2N6517C $V_{CE} = 10\text{V}, I_C = 5\text{mA}$ | 50 | 200 | |

Electrical Characteristics (Continued) $T_a = 25^\circ\text{C}$ unless otherwise noted

| Symbol | Parameter | Conditions | Min. | Max. | Units |
|---------------|--------------------------------------|--|------|------|-------|
| $V_{CE(sat)}$ | Collector-Emitter Saturation Voltage | $I_C = 10\text{mA}, I_B = 1\text{mA}$ | | 0.3 | V |
| | | $I_C = 20\text{mA}, I_B = 2\text{mA}$ | | 0.35 | V |
| | | $I_C = 30\text{mA}, I_B = 3\text{mA}$ | | 0.5 | V |
| | | $I_C = 50\text{mA}, I_B = 5\text{mA}$ | | 1 | V |
| $V_{BE(sat)}$ | Base-Emitter Saturation Voltage | $I_C = 10\text{mA}, I_B = 1\text{mA}$ | | 0.75 | V |
| | | $I_C = 20\text{mA}, I_B = 2\text{mA}$ | | 0.85 | V |
| | | $I_C = 30\text{mA}, I_B = 3\text{mA}$ | | 0.9 | V |
| C_{ob} | Output Capacitance | $V_{CB} = 20\text{V}, I_E = 0, f = 1\text{MHz}$ | | 6 | pF |
| f_T | Current Gain Bandwidth Product * | $I_C = 10\text{mA}, V_{CE} = 20\text{V}, f = 20\text{MHz}$ | 40 | 200 | MHz |
| $V_{BE(on)}$ | Base-Emitter On Voltage | $I_C = 100\text{mA}, V_{CE} = 10\text{V}$ | | 2 | V |

* Pulse Test: Pulse Width $\leq 300\mu\text{s}$, Duty Cycle $\leq 2\%$

Typical Performance Characteristics

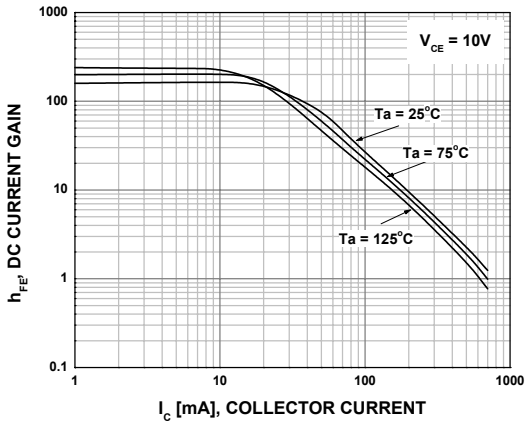

Figure 1. DC Current Gain

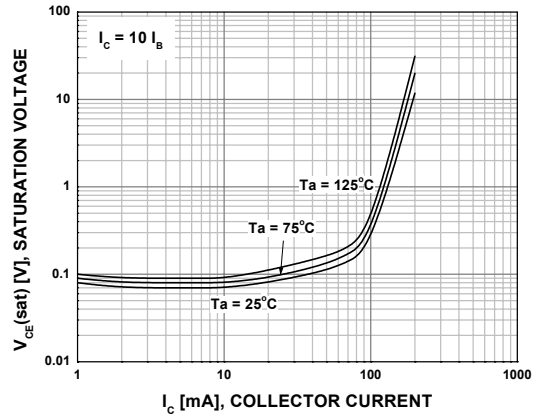

Figure 2. Saturation Voltage

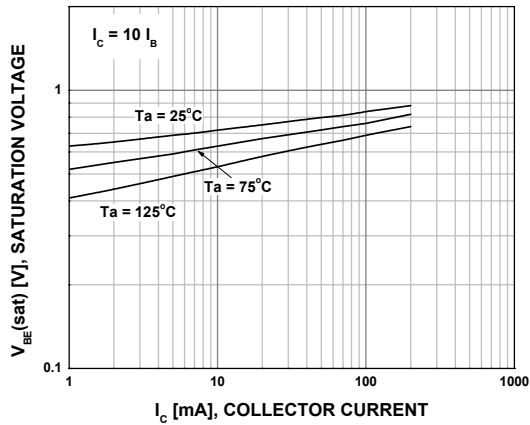

Figure 3. Saturation Voltage

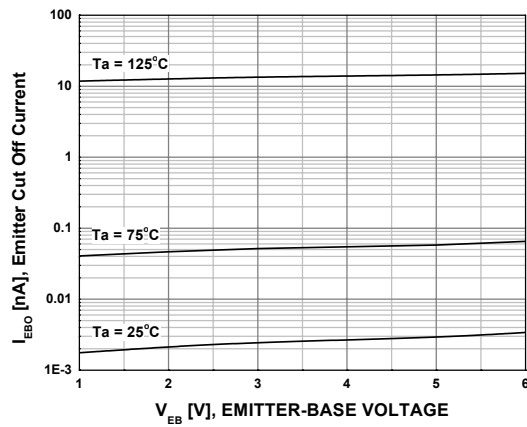

Figure 4. Emitter Cut Off Current

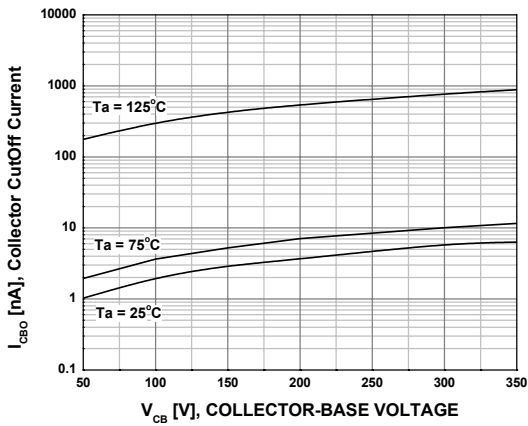

Figure 5. Collector CutOff Current

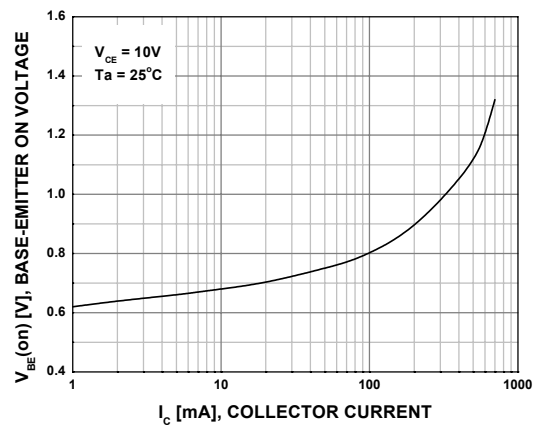

Figure 6. Base-Emitter On Voltage

Typical Performance Characteristics (Continued)

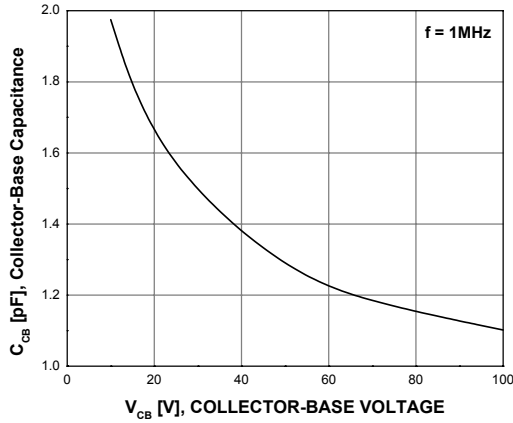

Figure 7. Output Capacitance

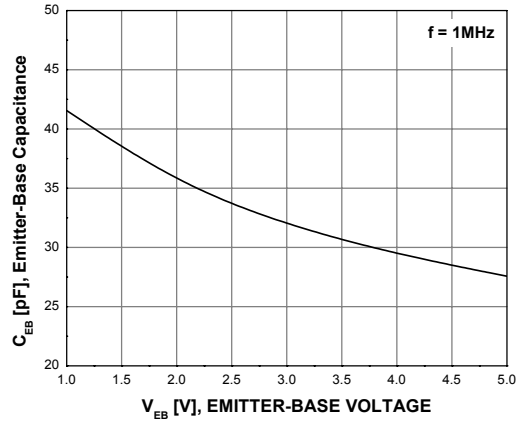

Figure 8. Input Capacitance

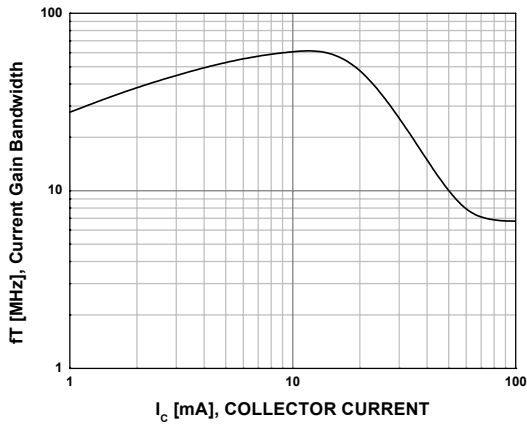

Figure 9. Current Gain Bandwidth Product

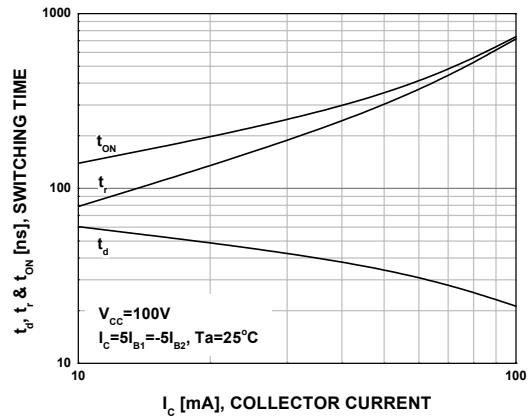

Figure 10. Resistive Load Switching

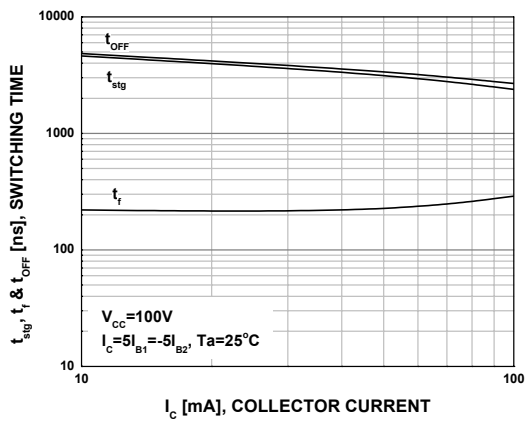
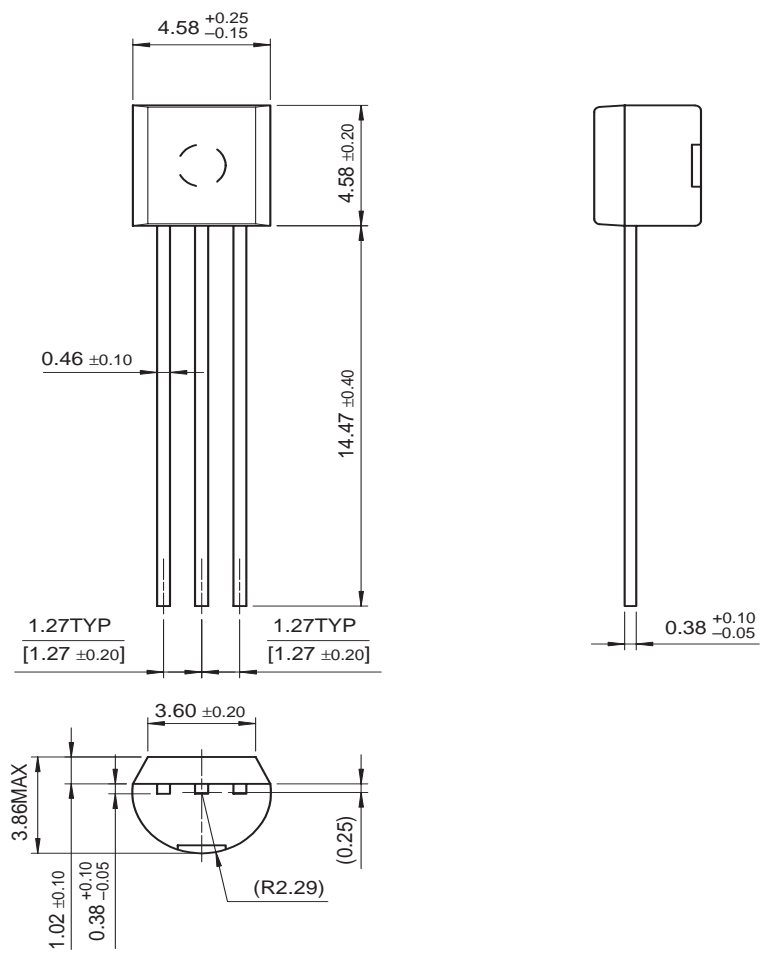

Figure 11. Resistive Load Switching

Physical Dimensions

TO-92



Dimensions in Millimeters



TRADEMARKS

The following includes registered and unregistered trademarks and service marks, owned by Fairchild Semiconductor and/or its global subsidiaries, and is not intended to be an exhaustive list of all such trademarks.

- | | | | |
|--------------------------|--------------------------|---------------------------------------|---|
| AccuPower™ | F-PFS™ | Power-SPM™ | <p>SYSTEM GENERAL® The Power Franchise® the power® franchise TinyBoost™ TinyBuck™ TinyCalc™ TinyLogic® TINYOPTO™ TinyPower™ TinyPWM™ TinyWire™ TriFault Detect™ TRUECURRENT™* µSerDes™ SerDes® UHC® Ultra FRFET™ UniFET™ VCX™ VisualMax™ XS™</p> |
| Auto-SPM™ | FRFET® | PowerTrench® | |
| Build it Now™ | Global Power Resource SM | PowerXS™ | |
| CorePLUS™ | Green FPS™ | Programmable Active Droop™ | |
| CorePOWER™ | Green FPS™ e-Series™ | QFET® | |
| CROSSVOLT™ | Gmax™ | QS™ | |
| CTL™ | GTO™ | Quiet Series™ | |
| Current Transfer Logic™ | IntelliMAX™ | RapidConfigure™ | |
| DEUXPEED® | ISOPLANAR™ | ™ | |
| Dual Cool™ | MegaBuck™ | Saving our world, 1mW/W/kW at a time™ | |
| EcoSPARK® | MICROCOUPLER™ | SignalWise™ | |
| EfficientMax™ | MicroFET™ | SmartMax™ | |
| ESBC™ | MicroPak™ | SMART START™ | |
| Fairchild® | MicroPak2™ | SPM® | |
| Fairchild Semiconductor® | MillerDrive™ | STEALTH™ | |
| FACT Quiet Series™ | MotionMax™ | SuperFET™ | |
| FACT® | Motion-SPM™ | SuperSOT™-3 | |
| FAST® | OptoHit™ | SuperSOT™-6 | |
| FastvCore™ | OPTOLOGIC® | SuperSOT™-8 | |
| FETBench™ | OPTOPLANAR® | SupreMOS® | |
| FlashWriter®* | ™ | SyncFET™ | |
| FPS™ | PDP SPM™ | Sync-Lock™ | |

* Trademarks of System General Corporation, used under license by Fairchild Semiconductor.

DISCLAIMER

FAIRCHILD SEMICONDUCTOR RESERVES THE RIGHT TO MAKE CHANGES WITHOUT FURTHER NOTICE TO ANY PRODUCTS HEREIN TO IMPROVE RELIABILITY, FUNCTION, OR DESIGN. FAIRCHILD DOES NOT ASSUME ANY LIABILITY ARISING OUT OF THE APPLICATION OR USE OF ANY PRODUCT OR CIRCUIT DESCRIBED HEREIN; NEITHER DOES IT CONVEY ANY LICENSE UNDER ITS PATENT RIGHTS, NOR THE RIGHTS OF OTHERS. THESE SPECIFICATIONS DO NOT EXPAND THE TERMS OF FAIRCHILD'S WORLDWIDE TERMS AND CONDITIONS, SPECIFICALLY THE WARRANTY THEREIN, WHICH COVERS THESE PRODUCTS.

LIFE SUPPORT POLICY

FAIRCHILD'S PRODUCTS ARE NOT AUTHORIZED FOR USE AS CRITICAL COMPONENTS IN LIFE SUPPORT DEVICES OR SYSTEMS WITHOUT THE EXPRESS WRITTEN APPROVAL OF FAIRCHILD SEMICONDUCTOR CORPORATION.

As used herein:

- Life support devices or systems are devices or systems which, (a) are intended for surgical implant into the body or (b) support or sustain life, and (c) whose failure to perform when properly used in accordance with instructions for use provided in the labeling, can be reasonably expected to result in a significant injury of the user.
- A critical component in any component of a life support, device, or system whose failure to perform can be reasonably expected to cause the failure of the life support device or system, or to affect its safety or effectiveness.

ANTI-COUNTERFEITING POLICY

Fairchild Semiconductor Corporation's Anti-Counterfeiting Policy. Fairchild's Anti-Counterfeiting Policy is also stated on our external website, www.fairchildsemi.com, under Sales Support.

Counterfeiting of semiconductor parts is a growing problem in the industry. All manufacturers of semiconductor products are experiencing counterfeiting of their parts. Customers who inadvertently purchase counterfeit parts experience many problems such as loss of brand reputation, substandard performance, failed applications, and increased cost of production and manufacturing delays. Fairchild is taking strong measures to protect ourselves and our customers from the proliferation of counterfeit parts. Fairchild strongly encourages customers to purchase Fairchild parts either directly from Fairchild or from Authorized Fairchild Distributors who are listed by country on our web page cited above. Products customers buy either from Fairchild directly or from Authorized Fairchild Distributors are genuine parts, have full traceability, meet Fairchild's quality standards for handling and storage and provide access to Fairchild's full range of up-to-date technical and product information. Fairchild and our Authorized Distributors will stand behind all warranties and will appropriately address any warranty issues that may arise. Fairchild will not provide any warranty coverage or other assistance for parts bought from Unauthorized Sources. Fairchild is committed to combat this global problem and encourage our customers to do their part in stopping this practice by buying direct or from authorized distributors.

PRODUCT STATUS DEFINITIONS

Definition of Terms

| Datasheet Identification | Product Status | Definition |
|--------------------------|-----------------------|---|
| Advance Information | Formative / In Design | Datasheet contains the design specifications for product development. Specifications may change in any manner without notice. |
| Preliminary | First Production | Datasheet contains preliminary data; supplementary data will be published at a later date. Fairchild Semiconductor reserves the right to make changes at any time without notice to improve design. |
| No Identification Needed | Full Production | Datasheet contains final specifications. Fairchild Semiconductor reserves the right to make changes at any time without notice to improve the design. |
| Obsolete | Not In Production | Datasheet contains specifications on a product that is discontinued by Fairchild Semiconductor. The datasheet is for reference information only. |