

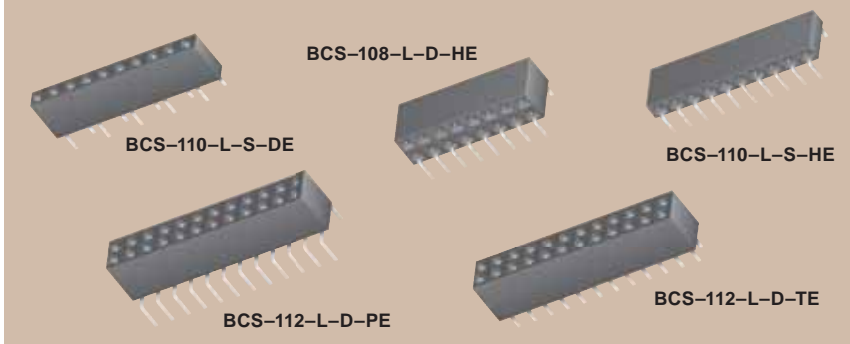

(2,54mm) .100"

BCS SERIES



STANDARD BOX CONTACT SOCKET

SPECIFICATIONS

For complete specifications see www.samtec.com?BCS

Insulator Material:

Black Liquid Crystal Polymer

Contact Material:

Phosphor Bronze

Plating:

Au or Sn over 50µ" (1,27µm) Ni

Voltage Rating:

475 VAC (-TE/-DE/-PE mated with TSM)

450 VAC (-HE mated with TSW)

Operating Temp Range:

-55°C to +125°C

Contact Resistance:

10 mΩ max

Insertion Depth:

(4,34mm) .171" to (7,24mm) .285" from top, (5,64mm) .222" plus board thickness minimum from bottom. -HE is (4,34mm) .171" to (6,35mm) .250"

Insertion Force:

(Single contact only) 5oz (1,39N) avg. (.025" (0,64mm) SQ pin)

Withdrawal Force:

(Single contact only) 3oz (0,83N) avg. (.025" (0,64mm) SQ pin)

RoHS Compliant:

Yes

Lead-Free Solderable:

Yes



BCS	1	NO. PINS PER ROW	PLATING OPTION	ROW OPTION	ENTRY OPTION	OTHER OPTION
			-L = 10µ" (0,25µm) Gold on contact, Matte Tin on tail	-S = Single		"XXX" = Polarized Position (-BE not available)
				-D = Double		

APPLICATION

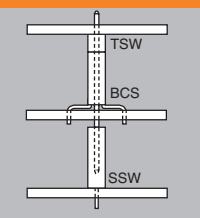

01 thru 50

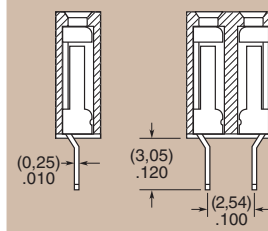
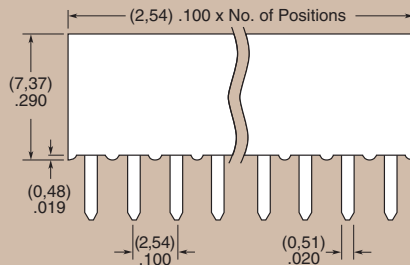
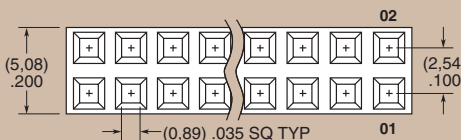
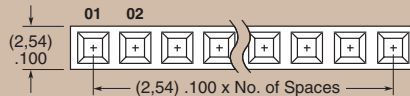

-TE
= Top Entry

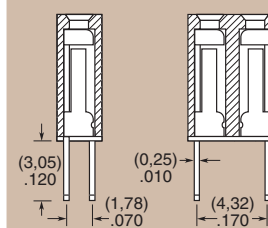

-DE
= Top Entry
(For Bottom Entry specify -DE-BE)
Cannot be used with plated through-holes

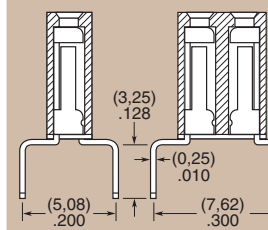

-PE
= Pass Through Entry
(For Bottom Entry specify -PE-BE)

APPLICATIONS

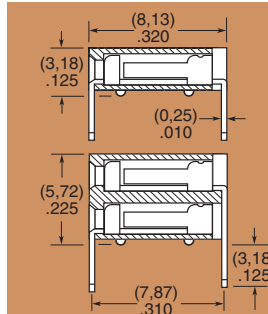
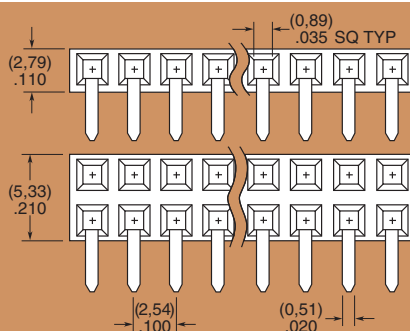
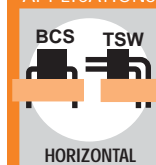

-HE
= Horizontal Entry

Note: Some lengths, styles and options are non-standard, non-returnable.

Due to technical progress, all designs, specifications and components are subject to change without notice.

WWW.SAMTEC.COM