



LIGHTING FOREVER

Technical Data Sheet

3.68*6.22mm Rectangular Legend LED Lamps

1003UYD/S530-A3/F14-9/S1339

■ Features :

- Choice of various viewing angles
- Available on tape and reel.
- Reliable and robust
- Pb free
- The product itself will remain within RoHS compliant version.

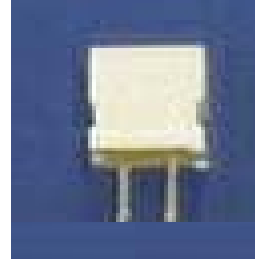

■ Descriptions :

- The series is specially designed for applications requiring higher brightness
- The led lamps are available with different colors, intensities.

■ Applications :

- TV set
- Monitor
- Telephone
- Computer

PART NO.	Material	Emitted Color	Lens Color
1003UYD/S530-A3/F14-9/S1339	AlGaInP	Brilliant Yellow	Yellow Diffused

Package Dimensions

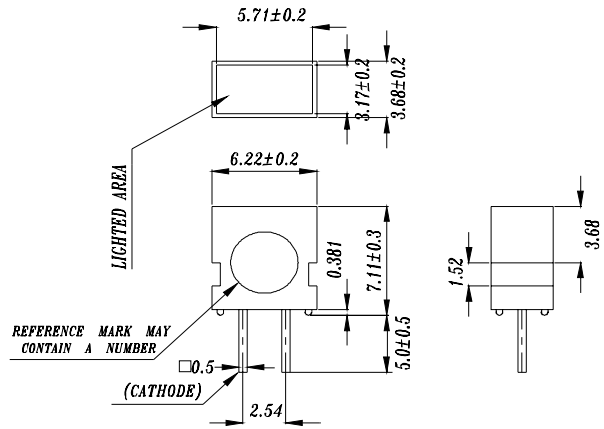

- Notes:
1. All dimensions are in millimetres
 2. The height of flange must be less than 1.5mm(0.059").
 3. Without special declared,the tolerance is±0.25mm.

■ Absolute Maximum Ratings at Ta = 25°C

Parameter	Symbol	Rating	Unit
Forward Current	IF	25	mA
Operating Temperature	Topr	-40 to +85	°C
Storage Temperature	Tstg	-40 to +100	°C
Soldering Temperature	Tsol	260	°C
Electrostatic Discharge	ESD	2000	V
Power Dissipation	Pd	60	mW
Peak Forward Current	IF(Peak)	60	mA
Reverse Voltage	VR	5	V

Note: *1:Soldering time ≤ 5 seconds.



LIGHTING FOREVER

Technical Data Sheet

3.68*6.22mm Rectangular Legend LED Lamps

1003UYD/S530-A3/F14-9/S1339

Electro-Optical Characteristics (Ta=25°C)

Parameter	Symbol	Condition	Min.	Typ.	Max.	Unit
Forward Voltage	V _F	I _F = 20 mA	/	2.0	2.4	V
Reverse Current	I _R	V _R = 5 V	/	/	10	μA
Luminous Intensity	I _v	I _F = 20 mA	16	32	/	mcd
Viewing Angle	2θ 1/2	I _F = 20 mA	/	110	/	deg
Peak Wavelength	λ _p	I _F = 20 mA	/	591	/	nm
Dominant Wavelength	λ _d	I _F = 20 mA	/	589	/	nm
Spectrum Radiation Bandwidth	Δλ	I _F = 20 mA	/	15	/	nm

■ Typical Electro-Optical Characteristic Curves:

(UY)

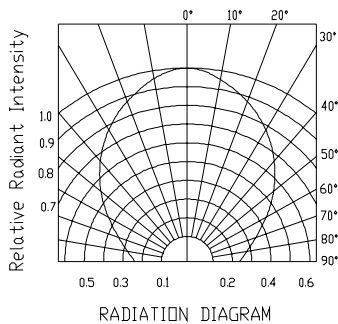
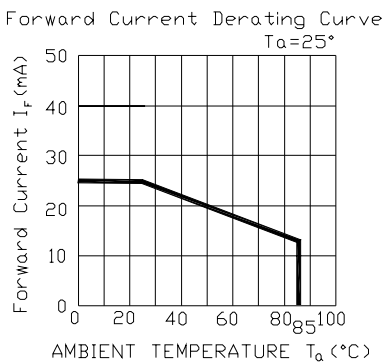
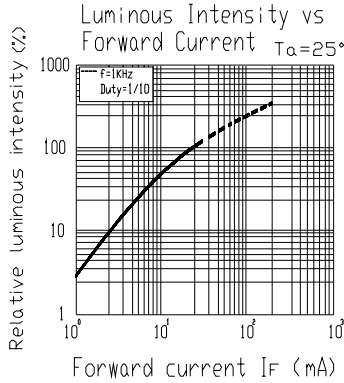
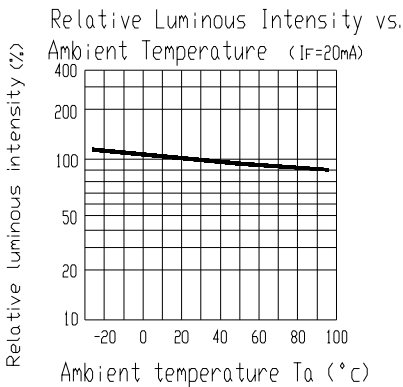
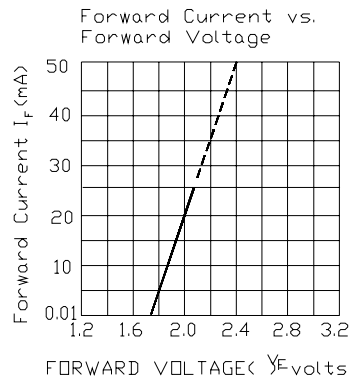
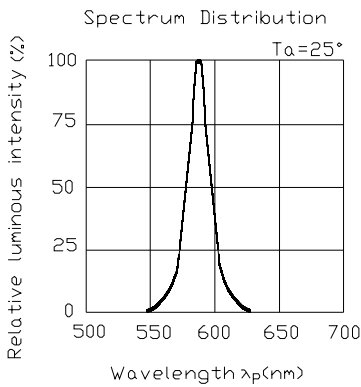



LIGHTING FOREVER

Technical Data Sheet

3.68*6.22mm Rectangular Legend LED Lamps

1003UYD/S530-A3/F14-9/S1339

■ Reliability test items and conditions:

The reliability of products shall be satisfied with items listed below.

Confidence level : 97%

LTPD : 3%

NO	Item	Test Conditions	Test Hours/Cycle	Sample Size	Failure Judgment Criteria	Ac/Re
1	Solder Heat	TEMP : 260°C ± 5 °C	10 SEC	76 PCS	$I_v \leq I_{vt} * 0.5$ or $V_f \geq U$ or $V_f \leq L$	0/1
2	Temperature Cycle	H : +100°C 15min \int 5 min L : -40°C 15min	300 CYCLES	76 PCS		0/1
3	Thermal Shock	H : +100°C 5min \int 10 sec L : -10°C 5min	300 CYCLES	76 PCS		0/1
4	High Temperature Storage	TEMP : 100°C	1000 HRS	76 PCS		0/1
5	Low Temperature Storage	TEMP : -40°C	1000 HRS	76 PCS		0/1
6	DC Operating Life	TEMP : 25°C $I_f = 20mA$	1000 HRS	76 PCS		0/1
7	High Temperature / High Humidity	85°C / 85% RH	1000 HRS	76 PCS		0/1

Note : I_{vt} : To test I_v value of the chip before the reliability test

I_v : The test value of the chip that has completed the reliability test

U : Upper Specification Limit

L : Lower Specification Limit



LIGHTING FOREVER

Technical Data Sheet

3.68*6.22mm Rectangular Legend LED Lamps

1003UYD/S530-A3/F14-9/S1339

Packing Quantity Specification

1.500PCS/1Bag · 5Bags/1Box

2.10Boxes/1Carton

Label Form Specification



CPN: Customer's Production Number

P/N : Production Number

QTY: Packing Quantity

CAT: Ranks

HUE: Dominant Wavelength

REF: Reference

LOT No: Lot Number

Notes

1. Above specification may be changed without notice. EVERLIGHT will reserve authority on material change for above specification.
2. When using this product, please observe the absolute maximum ratings and the instructions for using outlined in these specification sheets. EVERLIGHT assumes no responsibility for any damage resulting from use of the product which does not comply with the absolute maximum ratings and the instructions included in these specification sheets.
3. These specification sheets include materials protected under copyright of EVERLIGHT corporation. Please don't reproduce or cause anyone to reproduce them without EVERLIGHT's consent.

EVERLIGHT ELECTRONICS CO., LTD.

Tel: 886-2-2267-2000, 2267-9936

Office: No 25, Lane 76, Sec 3, Chung Yang Rd,

Fax: 886-2267-6244, 2267-6189, 2267-6306

Tucheng, Taipei 236, Taiwan, R.O.C

<http://www.everlight.com>

Soldering

■ Careful attention should be paid during soldering. When soldering, leave more than 3mm from solder joint to epoxy bulb, and soldering beyond the base of the tie bar is recommended.

■ Recommended soldering conditions:

Hand Soldering		DIP Soldering	
Temp. at tip of iron	300°C Max. (30W Max.)	Preheat temp.	100°C Max. (60 sec Max.)
Soldering time	3 sec Max.	Bath temp. & time	260 Max., 5 sec Max
Distance	3mm Min.(From solder joint to epoxy bulb)	Distance	3mm Min. (From solder joint to epoxy bulb)

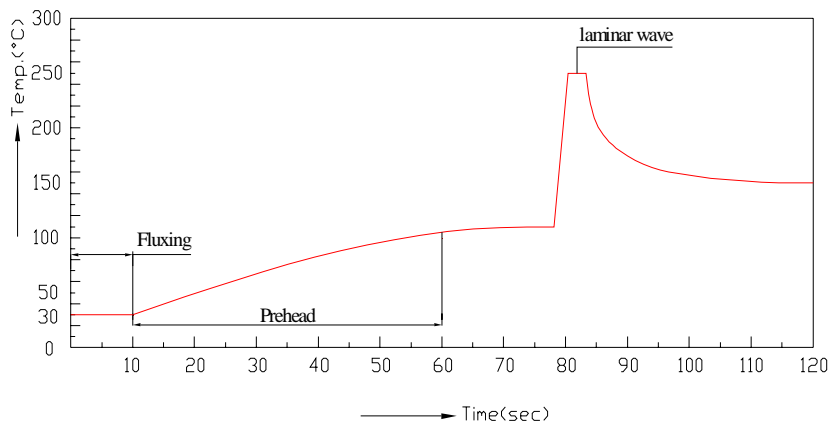

- Avoiding applying any stress to the lead frame while the LEDs are at high temperature particularly when soldering.
- Dip and hand soldering should not be done more than one time
- After soldering the LEDs, the epoxy bulb should be protected from mechanical shock or vibration until the LEDs return to room temperature.
- A rapid-rate process is not recommended for cooling the LEDs down from the peak temperature.
- Although the recommended soldering conditions are specified in the above table, dip or handsoldering at the lowest possible temperature is desirable for the LEDs.
- Wave soldering parameter must be set and maintain according to recommended temperature and dwell time in the solder wave.