



**ALPHA & OMEGA**  
SEMICONDUCTOR



**AOL1420**

**N-Channel Enhancement Mode Field Effect Transistor**

**General Description**

The AOL1420 uses advanced trench technology to provide excellent  $R_{DS(ON)}$ , low gate charge and low gate resistance. This device is ideally suited for use as a low side switch in CPU core power conversion.

- RoHS Compliant
- Halogen and Antimony Free Green Device\*

**Features**

$V_{DS}$  (V) = 30V  
 $I_D$  = 85A ( $V_{GS}$  = 10V)  
 $R_{DS(ON)} < 3.7m\Omega$  ( $V_{GS}$  = 10V)  
 $R_{DS(ON)} < 5.5m\Omega$  ( $V_{GS}$  = 4.5V)

UIS Tested  
 Rg,Ciss,Coss,Crss Tested

Ultra SO-8™ Top View

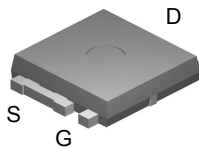

Bottom tab  
connected to  
drain

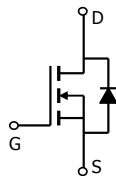

**Absolute Maximum Ratings  $T_A=25^\circ\text{C}$  unless otherwise noted**

Parameter	Symbol	Maximum	Units
Drain-Source Voltage	$V_{DS}$	30	V
Gate-Source Voltage	$V_{GS}$	$\pm 20$	V
Continuous Drain Current <sup>B,G</sup>	$I_D$	$T_C=25^\circ\text{C}$ <sup>G</sup>	85
		$T_C=100^\circ\text{C}$ <sup>B</sup>	63
Pulsed Drain Current	$I_{DM}$	150	A
Continuous Drain Current <sup>G</sup>	$I_{DSM}$	$T_A=25^\circ\text{C}$	19
		$T_A=70^\circ\text{C}$	15
Avalanche Current <sup>C</sup>	$I_{AR}$	30	A
Repetitive avalanche energy $L=0.1mH$ <sup>C</sup>	$E_{AR}$	112	mJ
Power Dissipation <sup>B</sup>	$P_D$	$T_C=25^\circ\text{C}$	100
		$T_C=100^\circ\text{C}$	50
Power Dissipation <sup>A</sup>	$P_{DSM}$	$T_A=25^\circ\text{C}$	2.08
		$T_A=70^\circ\text{C}$	1.3
Junction and Storage Temperature Range	$T_J, T_{STG}$	-55 to 175	$^\circ\text{C}$

**Thermal Characteristics**

Parameter	Symbol	Typ	Max	Units
Maximum Junction-to-Ambient <sup>A</sup>	$R_{\theta JA}$	$t \leq 10s$	19.6	25
Maximum Junction-to-Ambient <sup>A</sup>		Steady-State	50	60
Maximum Junction-to-Case <sup>C</sup>	$R_{\theta JC}$	0.9	1.5	$^\circ\text{C/W}$

**Electrical Characteristics (T<sub>J</sub>=25°C unless otherwise noted)**

Symbol	Parameter	Conditions	Min	Typ	Max	Units
<b>STATIC PARAMETERS</b>						
BV <sub>DSS</sub>	Drain-Source Breakdown Voltage	I <sub>D</sub> =250μA, V <sub>GS</sub> =0V	30			V
I <sub>DSS</sub>	Zero Gate Voltage Drain Current	V <sub>DS</sub> =24V, V <sub>GS</sub> =0V T <sub>J</sub> =55°C			1 5	μA
I <sub>GSS</sub>	Gate-Body leakage current	V <sub>DS</sub> =0V, V <sub>GS</sub> = ±20V			100	nA
V <sub>GS(th)</sub>	Gate Threshold Voltage	V <sub>DS</sub> =V <sub>GS</sub> I <sub>D</sub> =250μA	1	1.8	3	V
I <sub>D(ON)</sub>	On state drain current	V <sub>GS</sub> =10V, V <sub>DS</sub> =5V	85			A
R <sub>DS(ON)</sub>	Static Drain-Source On-Resistance	V <sub>GS</sub> =10V, I <sub>D</sub> =20A T <sub>J</sub> =125°C		2.9 4.4	3.7 5.5	mΩ
		V <sub>GS</sub> =4.5V, I <sub>D</sub> =20A		4.4	5.5	mΩ
g <sub>FS</sub>	Forward Transconductance	V <sub>DS</sub> =5V, I <sub>D</sub> =20A		106		S
V <sub>SD</sub>	Diode Forward Voltage	I <sub>S</sub> =1A, V <sub>GS</sub> =0V		0.72	1	V
I <sub>S</sub>	Maximum Body-Diode Continuous Current				85	A
<b>DYNAMIC PARAMETERS</b>						
C <sub>iss</sub>	Input Capacitance	V <sub>GS</sub> =0V, V <sub>DS</sub> =15V, f=1MHz		3700	4400	pF
C <sub>oss</sub>	Output Capacitance			700		pF
C <sub>rss</sub>	Reverse Transfer Capacitance			390		pF
R <sub>g</sub>	Gate resistance	V <sub>GS</sub> =0V, V <sub>DS</sub> =0V, f=1MHz		0.54	0.7	Ω
<b>SWITCHING PARAMETERS</b>						
Q <sub>g</sub> (10V)	Total Gate Charge	V <sub>GS</sub> =4.5V, V <sub>DS</sub> =15V, I <sub>D</sub> =20A		63	76	nC
Q <sub>g</sub> (4.5V)	Total Gate Charge			33	40	nC
Q <sub>gs</sub>	Gate Source Charge			8.6		nC
Q <sub>gd</sub>	Gate Drain Charge			17.6		nC
t <sub>D(on)</sub>	Turn-On DelayTime	V <sub>GS</sub> =10V, V <sub>DS</sub> =15V, R <sub>L</sub> =0.75Ω, R <sub>GEN</sub> =3Ω		12		ns
t <sub>r</sub>	Turn-On Rise Time			15.5		ns
t <sub>D(off)</sub>	Turn-Off DelayTime			40		ns
t <sub>f</sub>	Turn-Off Fall Time			14		ns
t <sub>rr</sub>	Body Diode Reverse Recovery Time	I <sub>F</sub> =20A, dI/dt=100A/μs		34	41	ns
Q <sub>rr</sub>	Body Diode Reverse Recovery Charge	I <sub>F</sub> =20A, dI/dt=100A/μs		30		nC

A: The value of R<sub>θJA</sub> is measured with the device in a still air environment with T<sub>A</sub> =25°C.  
 B: The power dissipation P<sub>D</sub> is based on T<sub>J(MAX)</sub>=175°C, using junction-to-case thermal resistance, and is more useful in setting the upper dissipation limit for cases where additional heatsinking is used.  
 C: Repetitive rating, pulse width limited by junction temperature T<sub>J(MAX)</sub>=175°C.  
 D: The R<sub>θJA</sub> is the sum of the thermal impedance from junction to case R<sub>θJC</sub> and case to ambient.  
 E: The static characteristics in Figures 1 to 6 are obtained using <300 μs pulses, duty cycle 0.5% max.  
 F: These curves are based on the junction-to-case thermal impedance which is measured with the device mounted to a large heatsink, assuming a maximum junction temperature of T<sub>J(MAX)</sub>=175°C.  
 G: The maximum current rating is limited by bond-wires.  
 \* This device is guaranteed green after date code 8P11 (June 1<sup>ST</sup> 2008)  
 Rev3: Jun 2008

THIS PRODUCT HAS BEEN DESIGNED AND QUALIFIED FOR THE CONSUMER MARKET. APPLICATIONS OR USES AS CRITICAL COMPONENTS IN LIFE SUPPORT DEVICES OR SYSTEMS ARE NOT AUTHORIZED. AOS DOES NOT ASSUME ANY LIABILITY ARISING OUT OF SUCH APPLICATIONS OR USES OF ITS PRODUCTS. AOS RESERVES THE RIGHT TO IMPROVE PRODUCT DESIGN, FUNCTIONS AND RELIABILITY WITHOUT NOTICE.

TYPICAL ELECTRICAL AND THERMAL CHARACTERISTICS

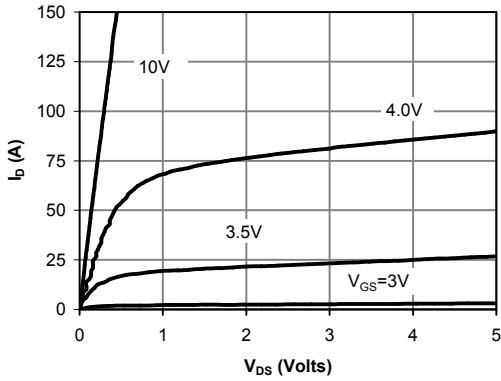

Fig 1: On-Region Characteristics

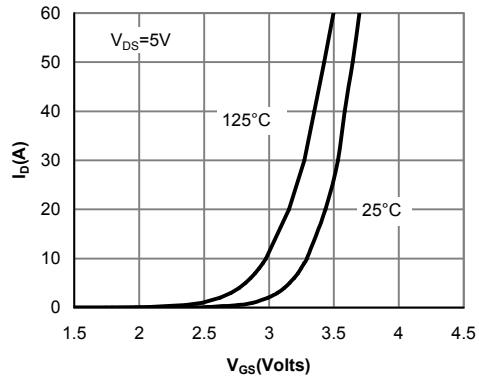

Figure 2: Transfer Characteristics

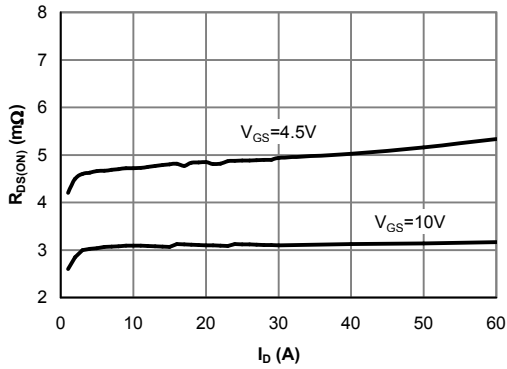

Figure 3: On-Resistance vs. Drain Current and Gate Voltage

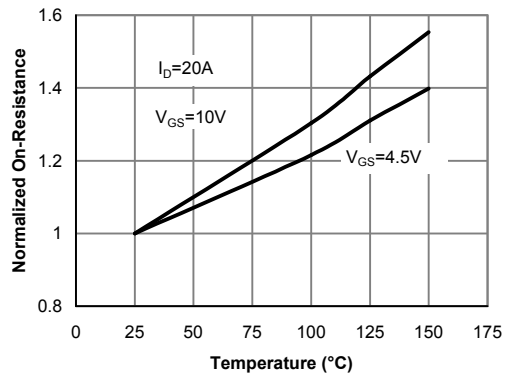

Figure 4: On-Resistance vs. Junction Temperature

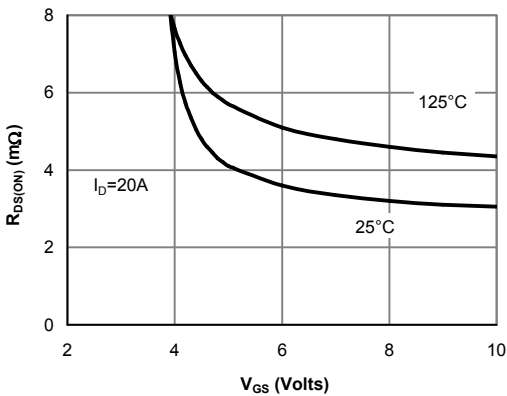

Figure 5: On-Resistance vs. Gate-Source Voltage

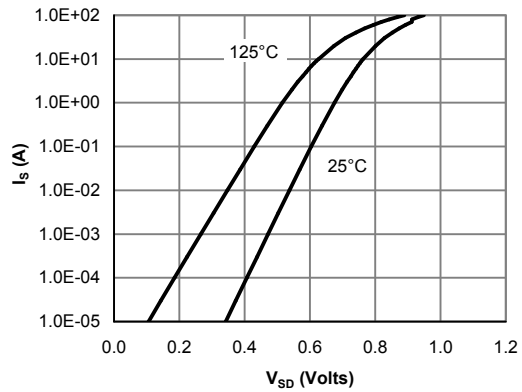

Figure 6: Body-Diode Characteristics

TYPICAL ELECTRICAL AND THERMAL CHARACTERISTICS

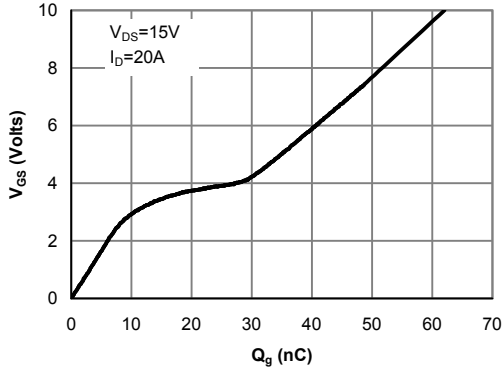

Figure 7: Gate-Charge Characteristics

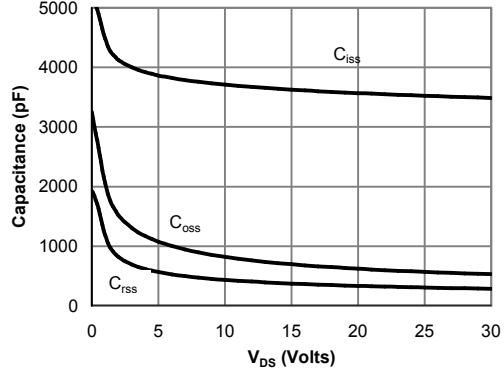

Figure 8: Capacitance Characteristics

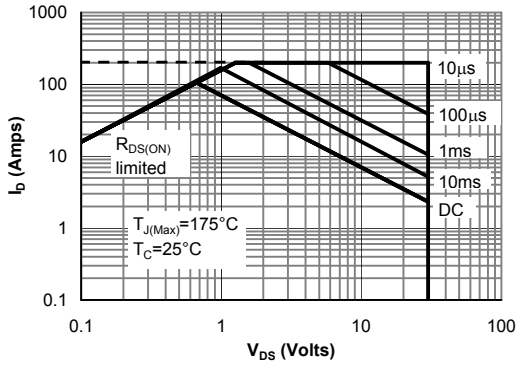

Figure 9: Maximum Forward Biased Safe Operating Area (Note F)

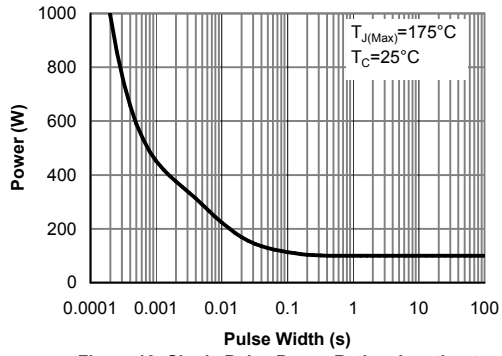

Figure 10: Single Pulse Power Rating Junction-to-Ambient (Note F)

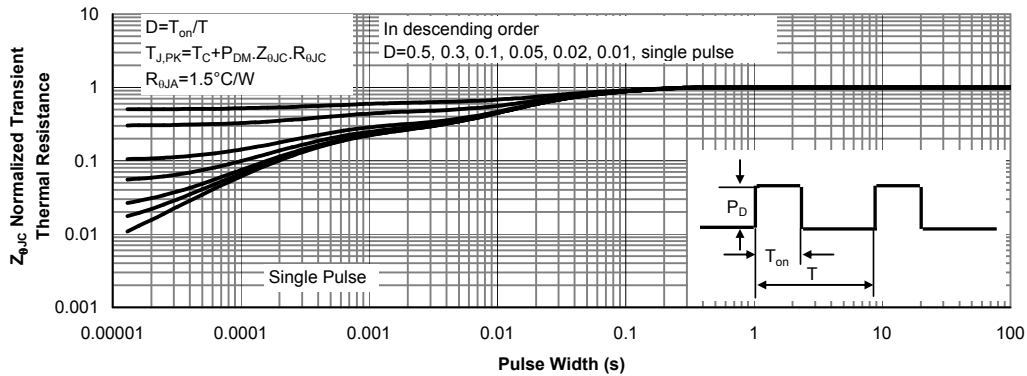

Figure 11: Normalized Maximum Transient Thermal Impedance (Note F)

TYPICAL ELECTRICAL AND THERMAL CHARACTERISTICS

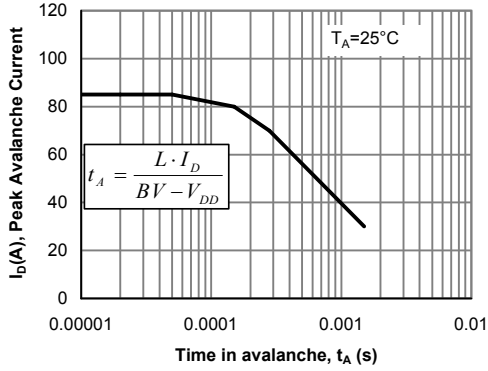

Figure 12: Single Pulse Avalanche capability

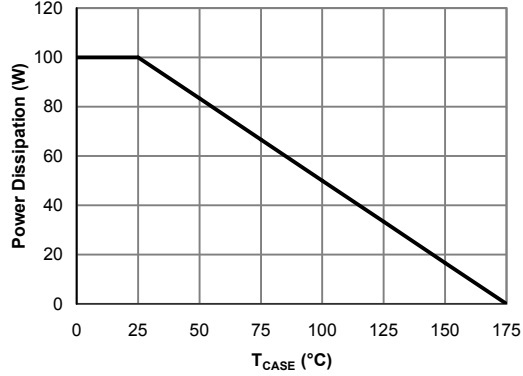

Figure 13: Power De-rating (Note B)

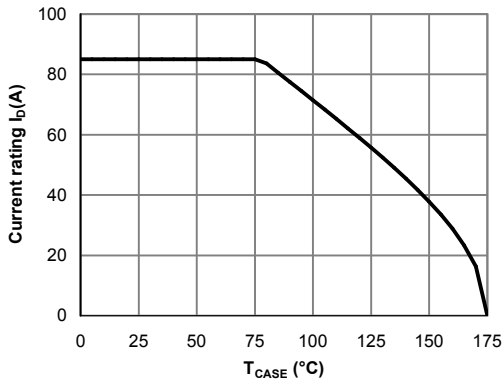

Figure 14: Current De-rating (Note B)

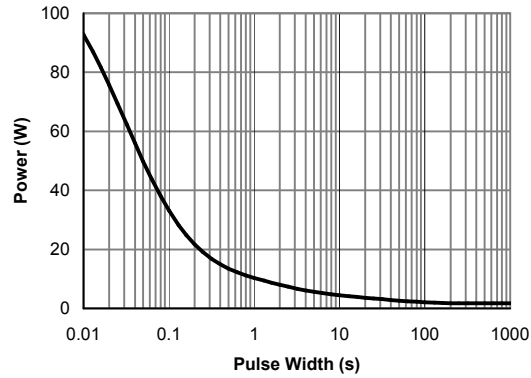

Figure 15: Single Pulse Power Rating Junction-to-Ambient (Note H)

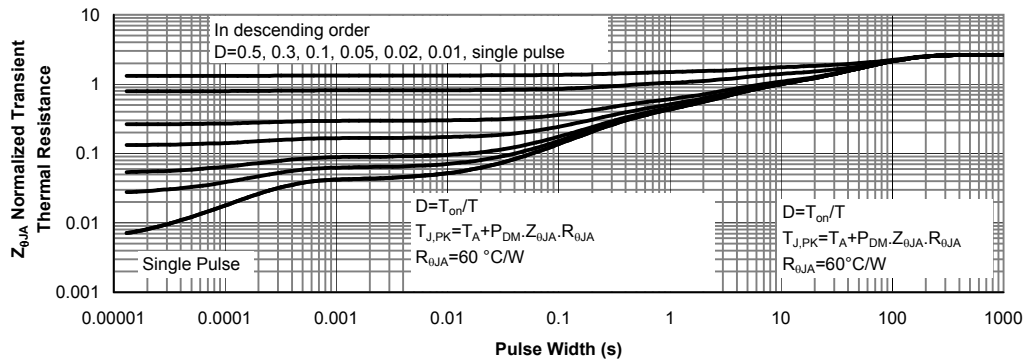
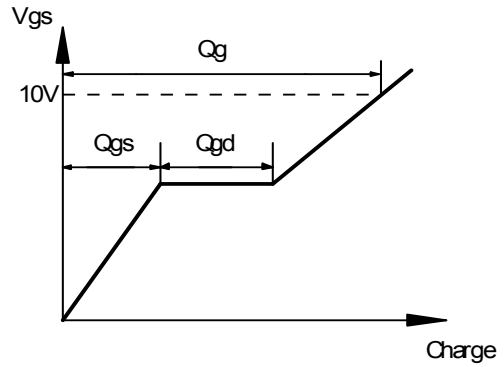
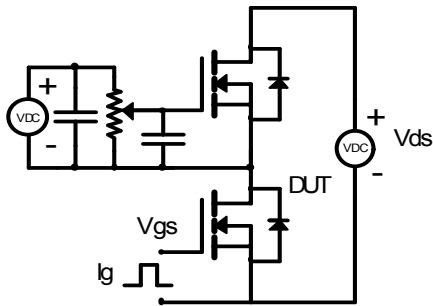
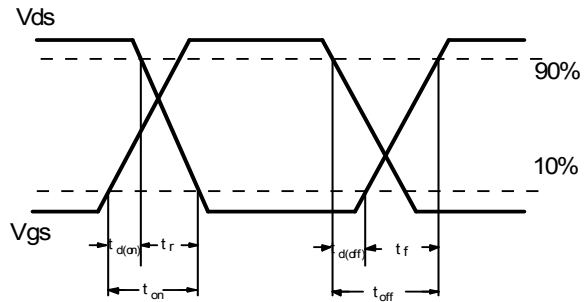
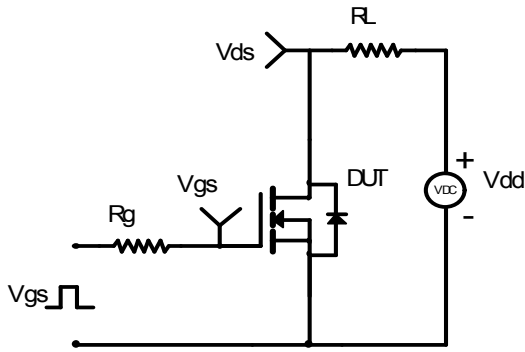

Figure 16: Normalized Maximum Transient Thermal Impedance (Note H)

Gate Charge Test Circuit & Waveform



Resistive Switching Test Circuit & Waveforms



Unclamped Inductive Switching (UIS) Test Circuit & Waveforms

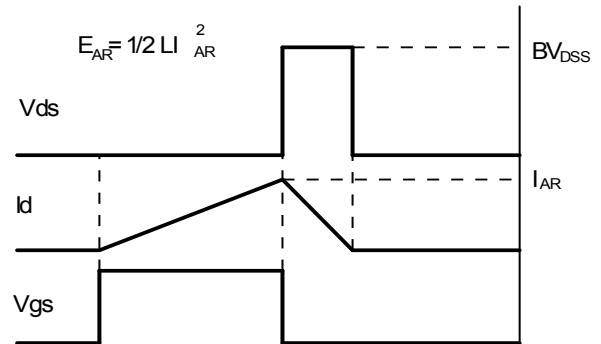
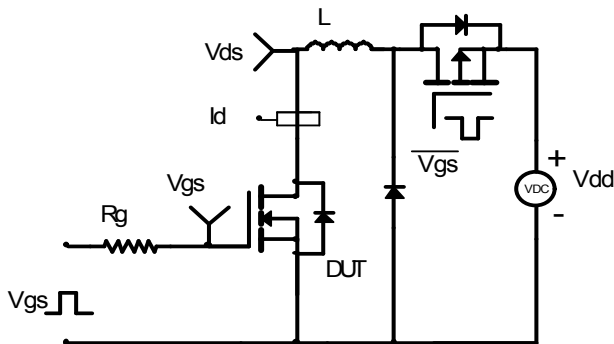

Diode Recovery Test Circuit & Waveforms

