

## LOW-POWER SINGLE AND DUAL-CHANNEL DIGITAL ISOLATORS

### Features

- High-speed operation
  - DC to 150 Mbps
- No start-up initialization required
- Wide Operating Supply Voltage
  - 2.5–5.5 V
- Up to 5000  $V_{RMS}$  isolation
- 60-year life at rated working voltage
- High electromagnetic immunity
- Ultra low power (typical)
  - 5 V Operation
    - 1.6 mA per channel at 1 Mbps
    - 5.5 mA per channel at 100 Mbps
  - 2.5 V Operation
    - 1.5 mA per channel at 1 Mbps
    - 3.5 mA per channel at 100 Mbps
- Schmitt trigger inputs
- Selectable fail-safe mode
  - Default high or low output (ordering option)
- Precise timing (typical)
  - 10 ns propagation delay
  - 1.5 ns pulse width distortion
  - 0.5 ns channel-channel skew
  - 2 ns propagation delay skew
  - 5 ns minimum pulse width
- Transient Immunity 50 kV/ $\mu$ s
- AEC-Q100 qualification
- Wide temperature range
  - –40 to 125 °C
- RoHS-compliant packages
  - SOIC-16 wide body
  - SOIC-8 narrow body

### Applications

- Industrial automation systems
- Medical electronics
- Hybrid electric vehicles
- Isolated switch mode supplies
- Isolated ADC, DAC
- Motor control
- Power inverters
- Communications systems

### Safety Regulatory Approvals

- UL 1577 recognized
  - Up to 5000  $V_{RMS}$  for 1 minute
- CSA component notice 5A approval
  - IEC 60950-1, 61010-1, 60601-1 (reinforced insulation)
- VDE certification conformity
  - IEC 60747-5-2 (VDE0884 Part 2)
  - EN60950-1 (reinforced insulation)

### Description

Silicon Lab's family of ultra-low-power digital isolators are CMOS devices offering substantial data rate, propagation delay, power, size, reliability, and external BOM advantages over legacy isolation technologies. The operating parameters of these products remain stable across wide temperature ranges and throughout device service life for ease of design and highly uniform performance. All device versions have Schmitt trigger inputs for high noise immunity and only require VDD bypass capacitors.

Data rates up to 150 Mbps are supported, and all devices achieve propagation delays of less than 10 ns. Ordering options include a choice of isolation ratings (3.75 and 5 kV) and a selectable fail-safe operating mode to control the default output state during power loss. All products >1 kV<sub>RMS</sub> are safety certified by UL, CSA, and VDE, and products in wide-body packages support reinforced insulation withstanding up to 5 kV<sub>RMS</sub>.

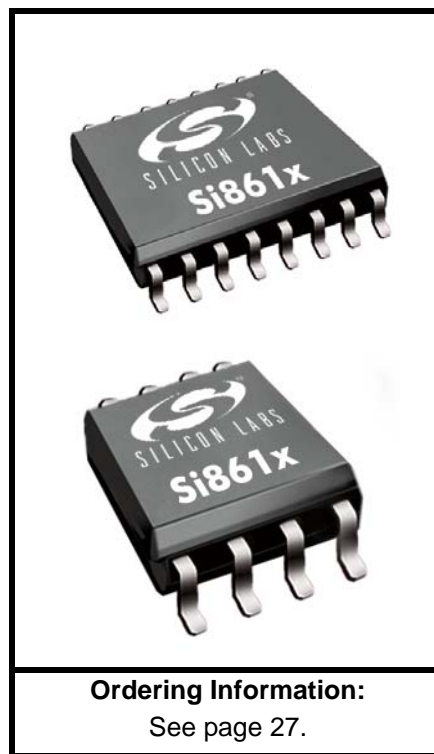



---

**TABLE OF CONTENTS**

---

| <b><u>Section</u></b>                                   | <b><u>Page</u></b> |
|---|--------------------|
| <b>1. Electrical Specifications</b> .....               | <b>4</b>           |
| <b>2. Functional Description</b> .....                  | <b>18</b>          |
| 2.1. Theory of Operation .....                          | 18                 |
| 2.2. Eye Diagram .....                                  | 19                 |
| <b>3. Device Operation</b> .....                        | <b>20</b>          |
| 3.1. Device Startup .....                               | 21                 |
| 3.2. Undervoltage Lockout .....                         | 21                 |
| 3.3. Layout Recommendations .....                       | 22                 |
| 3.4. Fail-Safe Operating Mode .....                     | 22                 |
| 3.5. Typical Performance Characteristics .....          | 23                 |
| <b>4. Pin Descriptions (Wide-Body SOIC)</b> .....       | <b>25</b>          |
| <b>5. Pin Descriptions (Narrow-Body SOIC)</b> .....     | <b>26</b>          |
| <b>6. Ordering Guide</b> .....                          | <b>27</b>          |
| <b>7. Package Outline: 16-Pin Wide Body SOIC</b> .....  | <b>28</b>          |
| <b>8. Land Pattern: 16-Pin Wide-Body SOIC</b> .....     | <b>30</b>          |
| <b>9. Package Outline: 8-Pin Narrow Body SOIC</b> ..... | <b>31</b>          |
| <b>10. Land Pattern: 8-Pin Narrow Body SOIC</b> .....   | <b>32</b>          |
| <b>11. Top Marking: 16-Pin Wide Body SOIC</b> .....     | <b>33</b>          |
| 11.1. 16-Pin Wide Body SOIC Top Marking .....           | 33                 |
| 11.2. Top Marking Explanation .....                     | 33                 |
| <b>12. Top Marking: 8-Pin Narrow Body SOIC</b> .....    | <b>34</b>          |
| 12.1. 8-Pin Narrow Body SOIC Top Marking .....          | 34                 |
| 12.2. Top Marking Explanation .....                     | 34                 |
| <b>Document Change List</b> .....                       | <b>35</b>          |
| <b>Contact Information</b> .....                        | <b>36</b>          |

## 1. Electrical Specifications

**Table 1. Recommended Operating Conditions**

| Parameter                      | Symbol    | Test Condition       | Min | Typ | Max  | Unit |
|--------------------------------|-----------|----------------------|-----|-----|------|------|
| Ambient Operating Temperature* | $T_A$     | 150 Mbps, 15 pF, 5 V | -40 | 25  | 125* | °C   |
| Supply Voltage                 | $V_{DD1}$ |                      | 2.5 | —   | 5.5  | V    |
|                                | $V_{DD2}$ |                      | 2.5 | —   | 5.5  | V    |

**\*Note:** The maximum ambient temperature is dependent on data frequency, output loading, number of operating channels, and supply voltage.

**Table 2. Electrical Characteristics**

( $V_{DD1} = 5\text{ V} \pm 10\%$ ,  $V_{DD2} = 5\text{ V} \pm 10\%$ ,  $T_A = -40$  to  $125\text{ }^\circ\text{C}$ )

| Parameter                             | Symbol    | Test Condition                | Min                      | Typ  | Max   | Unit |
|---------------------------------------|-----------|-------------------------------|--------------------------|------|-------|------|
| VDD Undervoltage Threshold            | VDDUV+    | $V_{DD1}$ , $V_{DD2}$ rising  | 1.95                     | 2.24 | 2.375 | V    |
| VDD Undervoltage Threshold            | VDDUV-    | $V_{DD1}$ , $V_{DD2}$ falling | 1.88                     | 2.16 | 2.325 | V    |
| VDD Negative-Going Lockout Hysteresis | VDDHYS    |                               | 50                       | 70   | 95    | mV   |
| Positive-Going Input Threshold        | VT+       | All inputs rising             | 1.4                      | 1.67 | 1.9   | V    |
| Negative-Going Input Threshold        | VT-       | All inputs falling            | 1.0                      | 1.23 | 1.4   | V    |
| Input Hysteresis                      | $V_{HYS}$ |                               | 0.38                     | 0.44 | 0.50  | V    |
| High Level Input Voltage              | $V_{IH}$  |                               | 2.0                      | —    | —     | V    |
| Low Level Input Voltage               | $V_{IL}$  |                               | —                        | —    | 0.8   | V    |
| High Level Output Voltage             | $V_{OH}$  | loh = -4 mA                   | $V_{DD1}, V_{DD2} - 0.4$ | 4.8  | —     | V    |
| Low Level Output Voltage              | $V_{OL}$  | lol = 4 mA                    | —                        | 0.2  | 0.4   | V    |
| Input Leakage Current                 | $I_L$     |                               | —                        | —    | ±10   | µA   |
| Output Impedance <sup>1</sup>         | $Z_O$     |                               | —                        | 50   | —     | Ω    |

**Notes:**

1. The nominal output impedance of an isolator driver channel is approximately  $50\ \Omega$ ,  $\pm 40\%$ , which is a combination of the value of the on-chip series termination resistor and channel resistance of the output driver FET. When driving loads where transmission line effects will be a factor, output pins should be appropriately terminated with controlled impedance PCB traces.
2.  $t_{PSK(P-P)}$  is the magnitude of the difference in propagation delay times measured between different units operating at the same supply voltages, load, and ambient temperature.
3. Start-up time is the time period from the application of power to valid data at the output.

**Table 2. Electrical Characteristics (Continued)** $(V_{DD1} = 5\text{ V} \pm 10\%, V_{DD2} = 5\text{ V} \pm 10\%, T_A = -40\text{ to }125\text{ }^\circ\text{C})$ 

| Parameter  | Symbol | Test Condition                     | Min | Typ | Max | Unit |
|--|--------|------------------------------------|-----|-----|-----|------|
| <b>DC Supply Current (All inputs 0 V or at Supply)</b>   |        |                                    |     |     |     |      |
| <b>Si8610Bx, Ex</b>  |        | $V_I = 0(\text{Bx}), 1(\text{Ex})$ | —   | 0.6 | 1.2 | mA   |
| $V_{DD1}$  |        | $V_I = 0(\text{Bx}), 1(\text{Ex})$ | —   | 0.8 | 1.5 |      |
| $V_{DD2}$  |        | $V_I = 1(\text{Bx}), 0(\text{Ex})$ | —   | 1.8 | 2.9 |      |
| $V_{DD1}$<br>$V_{DD2}$   |        | $V_I = 1(\text{Bx}), 0(\text{Ex})$ | —   | 0.8 | 1.5 |      |
| <b>Si8620Bx, Ex</b>  |        | $V_I = 0(\text{Bx}), 1(\text{Ex})$ | —   | 0.8 | 1.4 | mA   |
| $V_{DD1}$  |        | $V_I = 0(\text{Bx}), 1(\text{Ex})$ | —   | 1.4 | 2.2 |      |
| $V_{DD2}$  |        | $V_I = 1(\text{Bx}), 0(\text{Ex})$ | —   | 3.3 | 5.3 |      |
| $V_{DD1}$<br>$V_{DD2}$   |        | $V_I = 1(\text{Bx}), 0(\text{Ex})$ | —   | 1.4 | 2.2 |      |
| <b>Si8621Bx, Ex</b>  |        | $V_I = 0(\text{Bx}), 1(\text{Ex})$ | —   | 1.2 | 1.9 | mA   |
| $V_{DD1}$  |        | $V_I = 0(\text{Bx}), 1(\text{Ex})$ | —   | 1.2 | 1.9 |      |
| $V_{DD2}$  |        | $V_I = 1(\text{Bx}), 0(\text{Ex})$ | —   | 2.4 | 3.8 |      |
| $V_{DD1}$<br>$V_{DD2}$   |        | $V_I = 1(\text{Bx}), 0(\text{Ex})$ | —   | 2.4 | 3.8 |      |
| <b>Si8622Bx, Ex</b>  |        | $V_I = 0(\text{Bx}), 1(\text{Ex})$ | —   | 2.6 | 4.2 | mA   |
| $V_{DD1}$  |        | $V_I = 0(\text{Bx}), 1(\text{Ex})$ | —   | 3.3 | 5.3 |      |
| $V_{DD2}$  |        | $V_I = 1(\text{Bx}), 0(\text{Ex})$ | —   | 4.0 | 6.4 |      |
| $V_{DD1}$<br>$V_{DD2}$   |        | $V_I = 1(\text{Bx}), 0(\text{Ex})$ | —   | 4.8 | 7.7 |      |
| <b>1 Mbps Supply Current (All inputs = 500 kHz square wave, <math>C_I = 15\text{ pF}</math> on all outputs)</b>  |        |                                    |     |     |     |      |
| <b>Si8610Bx, Ex</b>  |        |                                    | —   | 1.2 | 2.0 | mA   |
| $V_{DD1}$<br>$V_{DD2}$   |        |                                    | —   | 0.9 | 1.5 |      |
| <b>Si8620Bx, Ex</b>  |        |                                    | —   | 2.1 | 3.1 | mA   |
| $V_{DD1}$<br>$V_{DD2}$   |        |                                    | —   | 1.6 | 2.4 |      |
| <b>Si8621Bx, Ex</b>  |        |                                    | —   | 1.9 | 2.9 | mA   |
| $V_{DD1}$<br>$V_{DD2}$   |        |                                    | —   | 1.9 | 2.9 |      |
| <b>Si8622Bx, Ex</b>  |        |                                    | —   | 3.4 | 5.1 | mA   |
| $V_{DD1}$<br>$V_{DD2}$   |        |                                    | —   | 4.2 | 6.2 |      |
| <b>Notes:</b>  |        |                                    |     |     |     |      |
| <ol style="list-style-type: none"> <li>The nominal output impedance of an isolator driver channel is approximately <math>50\ \Omega</math>, <math>\pm 40\%</math>, which is a combination of the value of the on-chip series termination resistor and channel resistance of the output driver FET. When driving loads where transmission line effects will be a factor, output pins should be appropriately terminated with controlled impedance PCB traces.</li> <li><math>t_{PSK(P-P)}</math> is the magnitude of the difference in propagation delay times measured between different units operating at the same supply voltages, load, and ambient temperature.</li> <li>Start-up time is the time period from the application of power to valid data at the output.</li> </ol> |        |                                    |     |     |     |      |

**Table 2. Electrical Characteristics (Continued)**

( $V_{DD1} = 5\text{ V} \pm 10\%$ ,  $V_{DD2} = 5\text{ V} \pm 10\%$ ,  $T_A = -40\text{ to }125\text{ }^\circ\text{C}$ )

| Parameter   | Symbol                | Test Condition | Min    | Typ        | Max          | Unit |
|---|-----------------------|----------------|--------|------------|--------------|------|
| <b>10 Mbps Supply Current</b> (All inputs = 5 MHz square wave, CI = 15 pF on all outputs)   |                       |                |        |            |              |      |
| <b>Si8610Bx, Ex</b><br>$V_{DD1}$<br>$V_{DD2}$   |                       |                | —<br>— | 1.2<br>1.2 | 2.0<br>2.0   | mA   |
| <b>Si8620Bx, Ex</b><br>$V_{DD1}$<br>$V_{DD2}$   |                       |                | —<br>— | 2.1<br>2.2 | 3.1<br>3.3   | mA   |
| <b>Si8621Bx, Ex</b><br>$V_{DD1}$<br>$V_{DD2}$   |                       |                | —<br>— | 2.2<br>2.2 | 3.3<br>3.3   | mA   |
| <b>Si8622Bx, Ex</b><br>$V_{DD1}$<br>$V_{DD2}$   |                       |                | —<br>— | 3.7<br>4.4 | 5.5<br>6.7   | mA   |
| <b>100 Mbps Supply Current</b> (All inputs = 50 MHz square wave, CI = 15 pF on all outputs)   |                       |                |        |            |              |      |
| <b>Si8610Bx, Ex</b><br>$V_{DD1}$<br>$V_{DD2}$   |                       |                | —<br>— | 1.2<br>4.8 | 2.0<br>6.7   | mA   |
| <b>Si8620Bx, Ex</b><br>$V_{DD1}$<br>$V_{DD2}$   |                       |                | —<br>— | 2.1<br>8.9 | 3.1<br>12.5  | mA   |
| <b>Si8621Bx, Ex</b><br>$V_{DD1}$<br>$V_{DD2}$   |                       |                | —<br>— | 5.8<br>5.8 | 8.1<br>8.1   | mA   |
| <b>Si8622Bx, Ex</b><br>$V_{DD1}$<br>$V_{DD2}$   |                       |                | —<br>— | 7.6<br>8.2 | 10.6<br>11.4 | mA   |
| <b>Timing Characteristics</b>   |                       |                |        |            |              |      |
| <b>Si861x/2x Bx, Ex</b>   |                       |                |        |            |              |      |
| Maximum Data Rate   |                       |                | 0      | —          | 150          | Mbps |
| Minimum Pulse Width   |                       |                | —      | —          | 5.0          | ns   |
| Propagation Delay   | $t_{PHL}$ , $t_{PLH}$ | See Figure 1   | 5.0    | 8.0        | 13           | ns   |
| Pulse Width Distortion<br>$ t_{PLH} - t_{PHL} $   | PWD                   | See Figure 1   | —      | 0.2        | 4.5          | ns   |
| Propagation Delay Skew <sup>2</sup>   | $t_{PSK(P-P)}$        |                | —      | 2.0        | 4.5          | ns   |
| Channel-Channel Skew  | $t_{PSK}$             |                | —      | 0.4        | 2.5          | ns   |
| <b>Notes:</b>   |                       |                |        |            |              |      |
| <ol style="list-style-type: none"> <li>1. The nominal output impedance of an isolator driver channel is approximately <math>50\ \Omega</math>, <math>\pm 40\%</math>, which is a combination of the value of the on-chip series termination resistor and channel resistance of the output driver FET. When driving loads where transmission line effects will be a factor, output pins should be appropriately terminated with controlled impedance PCB traces.</li> <li>2. <math>t_{PSK(P-P)}</math> is the magnitude of the difference in propagation delay times measured between different units operating at the same supply voltages, load, and ambient temperature.</li> <li>3. Start-up time is the time period from the application of power to valid data at the output.</li> </ol> |                       |                |        |            |              |      |

**Table 2. Electrical Characteristics (Continued)** $(V_{DD1} = 5\text{ V} \pm 10\%, V_{DD2} = 5\text{ V} \pm 10\%, T_A = -40\text{ to }125\text{ }^\circ\text{C})$ 

| Parameter                      | Symbol        | Test Condition                       | Min | Typ | Max | Unit              |
|--------------------------------|---------------|--------------------------------------|-----|-----|-----|-------------------|
| <b>All Models</b>              |               |                                      |     |     |     |                   |
| Output Rise Time               | $t_r$         | $C_L = 15\text{ pF}$<br>See Figure 1 | —   | 2.5 | 4.0 | ns                |
| Output Fall Time               | $t_f$         | $C_L = 15\text{ pF}$<br>See Figure 1 | —   | 2.5 | 4.0 | ns                |
| Peak Eye Diagram Jitter        | $t_{JIT(PK)}$ | See Figure 6                         | —   | 350 | —   | ps                |
| Common Mode Transient Immunity | CMTI          | $V_I = V_{DD}$ or 0 V                | 35  | 50  | —   | kV/ $\mu\text{s}$ |
| Startup Time <sup>3</sup>      | $t_{SU}$      |                                      | —   | 15  | 40  | $\mu\text{s}$     |

**Notes:**

1. The nominal output impedance of an isolator driver channel is approximately  $50\ \Omega$ ,  $\pm 40\%$ , which is a combination of the value of the on-chip series termination resistor and channel resistance of the output driver FET. When driving loads where transmission line effects will be a factor, output pins should be appropriately terminated with controlled impedance PCB traces.
2.  $t_{PSK(P-P)}$  is the magnitude of the difference in propagation delay times measured between different units operating at the same supply voltages, load, and ambient temperature.
3. Start-up time is the time period from the application of power to valid data at the output.

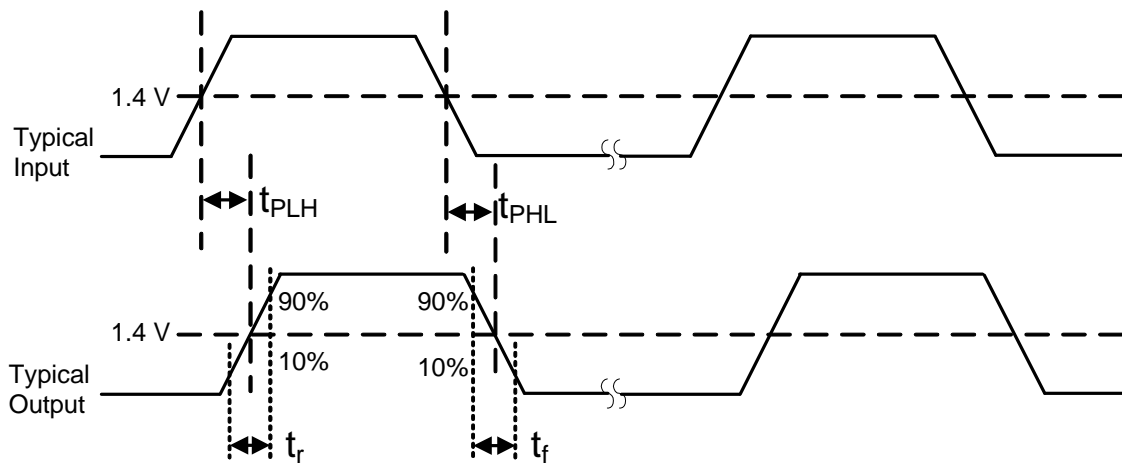
**Figure 1. Propagation Delay Timing**

# Si8610/20/21/22

**Table 3. Electrical Characteristics**

( $V_{DD1} = 3.3\text{ V} \pm 10\%$ ,  $V_{DD2} = 3.3\text{ V} \pm 10\%$ ,  $T_A = -40$  to  $125\text{ }^\circ\text{C}$ )

| Parameter  | Symbol             | Test Condition                | Min                      | Typ  | Max   | Unit |
|--|--------------------|-------------------------------|--------------------------|------|-------|------|
| VDD Undervoltage Threshold   | VDDUV+             | $V_{DD1}, V_{DD2}$ rising     | 1.95                     | 2.24 | 2.375 | V    |
| VDD Undervoltage Threshold   | VDDUV-             | $V_{DD1}, V_{DD2}$ falling    | 1.88                     | 2.16 | 2.325 | V    |
| VDD Negative-Going Lockout Hysteresis  | VDD <sub>HYS</sub> |                               | 50                       | 70   | 95    | mV   |
| Positive-Going Input Threshold   | VT+                | All inputs rising             | 1.4                      | 1.67 | 1.9   | V    |
| Negative-Going Input Threshold   | VT-                | All inputs falling            | 1.0                      | 1.23 | 1.4   | V    |
| Input Hysteresis   | V <sub>HYS</sub>   |                               | 0.38                     | 0.44 | 0.50  | V    |
| High Level Input Voltage   | V <sub>IH</sub>    |                               | 2.0                      | —    | —     | V    |
| Low Level Input Voltage  | V <sub>IL</sub>    |                               | —                        | —    | 0.8   | V    |
| High Level Output Voltage  | V <sub>OH</sub>    | loh = -4 mA                   | $V_{DD1}, V_{DD2} - 0.4$ | 3.1  | —     | V    |
| Low Level Output Voltage   | V <sub>OL</sub>    | lol = 4 mA                    | —                        | 0.2  | 0.4   | V    |
| Input Leakage Current  | I <sub>L</sub>     |                               | —                        | —    | ±10   | µA   |
| Output Impedance <sup>1</sup>  | Z <sub>O</sub>     |                               | —                        | 50   | —     | Ω    |
| <b>DC Supply Current (All inputs 0 V or at supply)</b>   |                    |                               |                          |      |       |      |
| <b>Si8610Bx, Ex</b>  |                    |                               |                          |      |       |      |
| V <sub>DD1</sub>   |                    | V <sub>I</sub> = 0(Bx), 1(Ex) | —                        | 0.6  | 1.2   | mA   |
| V <sub>DD2</sub>   |                    | V <sub>I</sub> = 0(Bx), 1(Ex) | —                        | 0.8  | 1.5   |      |
| V <sub>DD1</sub>   |                    | V <sub>I</sub> = 1(Bx), 0(Ex) | —                        | 1.8  | 2.9   |      |
| V <sub>DD2</sub>   |                    | V <sub>I</sub> = 1(Bx), 0(Ex) | —                        | 0.8  | 1.5   |      |
| <b>Si8620Bx, Ex</b>  |                    |                               |                          |      |       |      |
| V <sub>DD1</sub>   |                    | V <sub>I</sub> = 0(Bx), 1(Ex) | —                        | 0.8  | 1.4   | mA   |
| V <sub>DD2</sub>   |                    | V <sub>I</sub> = 0(Bx), 1(Ex) | —                        | 1.4  | 2.2   |      |
| V <sub>DD1</sub>   |                    | V <sub>I</sub> = 1(Bx), 0(Ex) | —                        | 3.3  | 5.3   |      |
| V <sub>DD2</sub>   |                    | V <sub>I</sub> = 1(Bx), 0(Ex) | —                        | 1.4  | 2.2   |      |
| <b>Si8621Bx, Ex</b>  |                    |                               |                          |      |       |      |
| V <sub>DD1</sub>   |                    | V <sub>I</sub> = 0(Bx), 1(Ex) | —                        | 1.2  | 1.9   | mA   |
| V <sub>DD2</sub>   |                    | V <sub>I</sub> = 0(Bx), 1(Ex) | —                        | 1.2  | 1.9   |      |
| V <sub>DD1</sub>   |                    | V <sub>I</sub> = 1(Bx), 0(Ex) | —                        | 2.4  | 3.8   |      |
| V <sub>DD2</sub>   |                    | V <sub>I</sub> = 1(Bx), 0(Ex) | —                        | 2.4  | 3.8   |      |
| <b>Si8622Bx, Ex</b>  |                    |                               |                          |      |       |      |
| V <sub>DD1</sub>   |                    | V <sub>I</sub> = 0(Bx), 1(Ex) | —                        | 2.6  | 4.2   | mA   |
| V <sub>DD2</sub>   |                    | V <sub>I</sub> = 0(Bx), 1(Ex) | —                        | 3.3  | 5.3   |      |
| V <sub>DD1</sub>   |                    | V <sub>I</sub> = 1(Bx), 0(Ex) | —                        | 4.0  | 6.4   |      |
| V <sub>DD2</sub>   |                    | V <sub>I</sub> = 1(Bx), 0(Ex) | —                        | 4.8  | 7.7   |      |
| <b>Notes:</b>  |                    |                               |                          |      |       |      |
| <ol style="list-style-type: none"> <li>1. The nominal output impedance of an isolator driver channel is approximately 50 Ω, ±40%, which is a combination of the value of the on-chip series termination resistor and channel resistance of the output driver FET. When driving loads where transmission line effects will be a factor, output pins should be appropriately terminated with controlled impedance PCB traces.</li> <li>2. t<sub>PSK(P-P)</sub> is the magnitude of the difference in propagation delay times measured between different units operating at the same supply voltages, load, and ambient temperature.</li> <li>3. Start-up time is the time period from the application of power to valid data at the output.</li> </ol> |                    |                               |                          |      |       |      |



**Table 3. Electrical Characteristics (Continued)** $(V_{DD1} = 3.3\text{ V} \pm 10\%, V_{DD2} = 3.3\text{ V} \pm 10\%, T_A = -40\text{ to }125\text{ }^\circ\text{C})$ 

| Parameter   | Symbol | Test Condition | Min    | Typ        | Max        | Unit |
|---|--------|----------------|--------|------------|------------|------|
| <b>1 Mbps Supply Current</b> (All inputs = 500 kHz square wave, CI = 15 pF on all outputs)  |        |                |        |            |            |      |
| <b>Si8610Bx, Ex</b><br>$V_{DD1}$<br>$V_{DD2}$   |        |                | —<br>— | 1.2<br>0.9 | 2.0<br>1.5 | mA   |
| <b>Si8620Bx, Ex</b><br>$V_{DD1}$<br>$V_{DD2}$   |        |                | —<br>— | 2.1<br>1.6 | 3.1<br>2.4 | mA   |
| <b>Si8621Bx, Ex</b><br>$V_{DD1}$<br>$V_{DD2}$   |        |                | —<br>— | 1.9<br>1.9 | 2.9<br>2.9 | mA   |
| <b>Si8622Bx, Ex</b><br>$V_{DD1}$<br>$V_{DD2}$   |        |                | —<br>— | 3.4<br>4.2 | 5.1<br>6.2 | mA   |
| <b>10 Mbps Supply Current</b> (All inputs = 5 MHz square wave, CI = 15 pF on all outputs)   |        |                |        |            |            |      |
| <b>Si8610Bx, Ex</b><br>$V_{DD1}$<br>$V_{DD2}$   |        |                | —<br>— | 1.2<br>1.0 | 2.0<br>1.8 | mA   |
| <b>Si8620Bx, Ex</b><br>$V_{DD1}$<br>$V_{DD2}$   |        |                | —<br>— | 2.1<br>1.9 | 3.1<br>2.8 | mA   |
| <b>Si8621Bx, Ex</b><br>$V_{DD1}$<br>$V_{DD2}$   |        |                | —<br>— | 2.0<br>2.0 | 3.0<br>3.0 | mA   |
| <b>Si8622Bx, Ex</b><br>$V_{DD1}$<br>$V_{DD2}$   |        |                | —<br>— | 3.5<br>4.3 | 5.3<br>6.4 | mA   |
| <b>100 Mbps Supply Current</b> (All inputs = 50 MHz square wave, CI = 15 pF on all outputs) |        |                |        |            |            |      |
| <b>Si8610Bx, Ex</b><br>$V_{DD1}$<br>$V_{DD2}$   |        |                | —<br>— | 1.2<br>3.4 | 2.0<br>5.1 | mA   |
| <b>Si8620Bx, Ex</b><br>$V_{DD1}$<br>$V_{DD2}$   |        |                | —<br>— | 2.1<br>6.3 | 3.1<br>8.8 | mA   |
| <b>Si8621Bx, Ex</b><br>$V_{DD1}$<br>$V_{DD2}$   |        |                | —<br>— | 4.4<br>4.4 | 6.1<br>6.1 | mA   |
| <b>Si8622Bx, Ex</b><br>$V_{DD1}$<br>$V_{DD2}$   |        |                | —<br>— | 5.9<br>6.6 | 8.2<br>9.3 | mA   |

**Notes:**

1. The nominal output impedance of an isolator driver channel is approximately  $50\ \Omega$ ,  $\pm 40\%$ , which is a combination of the value of the on-chip series termination resistor and channel resistance of the output driver FET. When driving loads where transmission line effects will be a factor, output pins should be appropriately terminated with controlled impedance PCB traces.
2.  $t_{PSK(P-P)}$  is the magnitude of the difference in propagation delay times measured between different units operating at the same supply voltages, load, and ambient temperature.
3. Start-up time is the time period from the application of power to valid data at the output.

**Table 3. Electrical Characteristics (Continued)**

( $V_{DD1} = 3.3\text{ V} \pm 10\%$ ,  $V_{DD2} = 3.3\text{ V} \pm 10\%$ ,  $T_A = -40\text{ to }125\text{ }^\circ\text{C}$ )

| Parameter   | Symbol             | Test Condition                       | Min | Typ | Max | Unit              |
|---|--------------------|--------------------------------------|-----|-----|-----|-------------------|
| <b>Timing Characteristics</b>   |                    |                                      |     |     |     |                   |
| <b>Si861x/2x Bx, Ex</b>   |                    |                                      |     |     |     |                   |
| Maximum Data Rate   |                    |                                      | 0   | —   | 150 | Mbps              |
| Minimum Pulse Width   |                    |                                      | —   | —   | 5.0 | ns                |
| Propagation Delay   | $t_{PHL}, t_{PLH}$ | See Figure 1                         | 5.0 | 8.0 | 13  | ns                |
| Pulse Width Distortion<br>$ t_{PLH} - t_{PHL} $   | PWD                | See Figure 1                         | —   | 0.2 | 4.5 | ns                |
| Propagation Delay Skew <sup>2</sup>   | $t_{PSK(P-P)}$     |                                      | —   | 2.0 | 4.5 | ns                |
| Channel-Channel Skew  | $t_{PSK}$          |                                      | —   | 0.4 | 2.5 | ns                |
| <b>All Models</b>   |                    |                                      |     |     |     |                   |
| Output Rise Time  | $t_r$              | $C_L = 15\text{ pF}$<br>See Figure 1 | —   | 2.5 | 4.0 | ns                |
| Output Fall Time  | $t_f$              | $C_L = 15\text{ pF}$<br>See Figure 1 | —   | 2.5 | 4.0 | ns                |
| Peak Eye Diagram Jitter   | $t_{JIT(PK)}$      | See Figure 6                         | —   | 350 | —   | ps                |
| Common Mode Transient Immunity  | CMTI               | $V_I = V_{DD}$ or $0\text{ V}$       | 35  | 50  | —   | kV/ $\mu\text{s}$ |
| Start-up Time <sup>3</sup>  | $t_{SU}$           |                                      | —   | 15  | 40  | $\mu\text{s}$     |
| <b>Notes:</b>   |                    |                                      |     |     |     |                   |
| <ol style="list-style-type: none"> <li>1. The nominal output impedance of an isolator driver channel is approximately <math>50\ \Omega</math>, <math>\pm 40\%</math>, which is a combination of the value of the on-chip series termination resistor and channel resistance of the output driver FET. When driving loads where transmission line effects will be a factor, output pins should be appropriately terminated with controlled impedance PCB traces.</li> <li>2. <math>t_{PSK(P-P)}</math> is the magnitude of the difference in propagation delay times measured between different units operating at the same supply voltages, load, and ambient temperature.</li> <li>3. Start-up time is the time period from the application of power to valid data at the output.</li> </ol> |                    |                                      |     |     |     |                   |

**Table 4. Electrical Characteristics** $(V_{DD1} = 2.5\text{ V} \pm 5\%, V_{DD2} = 2.5\text{ V} \pm 5\%, T_A = -40\text{ to }125\text{ }^\circ\text{C})$ 

| Parameter   | Symbol    | Test Condition                     | Min                      | Typ  | Max      | Unit          |
|---|-----------|------------------------------------|--------------------------|------|----------|---------------|
| VDD Undervoltage Threshold  | VDDUV+    | $V_{DD1}, V_{DD2}$ rising          | 1.95                     | 2.24 | 2.375    | V             |
| VDD Undervoltage Threshold  | VDDUV-    | $V_{DD1}, V_{DD2}$ falling         | 1.88                     | 2.16 | 2.325    | V             |
| VDD Negative-Going Lockout Hysteresis   | VDDHYS    |                                    | 50                       | 70   | 95       | mV            |
| Positive-Going Input Threshold  | VT+       | All inputs rising                  | 1.6                      | —    | 1.9      | V             |
| Negative-Going Input Threshold  | VT-       | All inputs falling                 | 1.1                      | —    | 1.4      | V             |
| Input Hysteresis  | $V_{HYS}$ |                                    | 0.40                     | 0.45 | 0.50     | V             |
| High Level Input Voltage  | $V_{IH}$  |                                    | 2.0                      | —    | —        | V             |
| Low Level Input Voltage   | $V_{IL}$  |                                    | —                        | —    | 0.8      | V             |
| High Level Output Voltage   | $V_{OH}$  | loh = -4 mA                        | $V_{DD1}, V_{DD2} - 0.4$ | 2.3  | —        | V             |
| Low Level Output Voltage  | $V_{OL}$  | lol = 4 mA                         | —                        | 0.2  | 0.4      | V             |
| Input Leakage Current   | $I_L$     |                                    | —                        | —    | $\pm 10$ | $\mu\text{A}$ |
| Output Impedance <sup>1</sup>   | $Z_O$     |                                    | —                        | 50   | —        | $\Omega$      |
| <b>DC Supply Current (All inputs 0 V or at supply)</b>  |           |                                    |                          |      |          |               |
| <b>Si8610Bx, Ex</b>   |           |                                    |                          |      |          |               |
| $V_{DD1}$   |           | $V_I = 0(\text{Bx}), 1(\text{Ex})$ | —                        | 0.6  | 1.2      | mA            |
| $V_{DD2}$   |           | $V_I = 0(\text{Bx}), 1(\text{Ex})$ | —                        | 0.8  | 1.5      |               |
| $V_{DD1}$   |           | $V_I = 1(\text{Bx}), 0(\text{Ex})$ | —                        | 1.8  | 2.9      |               |
| $V_{DD2}$   |           | $V_I = 1(\text{Bx}), 0(\text{Ex})$ | —                        | 0.8  | 1.5      |               |
| <b>Si8620Bx, Ex</b>   |           |                                    |                          |      |          |               |
| $V_{DD1}$   |           | $V_I = 0(\text{Bx}), 1(\text{Ex})$ | —                        | 0.8  | 1.4      | mA            |
| $V_{DD2}$   |           | $V_I = 0(\text{Bx}), 1(\text{Ex})$ | —                        | 1.4  | 2.2      |               |
| $V_{DD1}$   |           | $V_I = 1(\text{Bx}), 0(\text{Ex})$ | —                        | 3.3  | 5.3      |               |
| $V_{DD2}$   |           | $V_I = 1(\text{Bx}), 0(\text{Ex})$ | —                        | 1.4  | 2.2      |               |
| <b>Si8621Bx, Ex</b>   |           |                                    |                          |      |          |               |
| $V_{DD1}$   |           | $V_I = 0(\text{Bx}), 1(\text{Ex})$ | —                        | 1.2  | 1.9      | mA            |
| $V_{DD2}$   |           | $V_I = 0(\text{Bx}), 1(\text{Ex})$ | —                        | 1.2  | 1.9      |               |
| $V_{DD1}$   |           | $V_I = 1(\text{Bx}), 0(\text{Ex})$ | —                        | 2.4  | 3.8      |               |
| $V_{DD2}$   |           | $V_I = 1(\text{Bx}), 0(\text{Ex})$ | —                        | 2.4  | 3.8      |               |
| <b>Si8622Bx, Ex</b>   |           |                                    |                          |      |          |               |
| $V_{DD1}$   |           | $V_I = 0(\text{Bx}), 1(\text{Ex})$ | —                        | 2.6  | 4.2      | mA            |
| $V_{DD2}$   |           | $V_I = 0(\text{Bx}), 1(\text{Ex})$ | —                        | 3.3  | 5.3      |               |
| $V_{DD1}$   |           | $V_I = 1(\text{Bx}), 0(\text{Ex})$ | —                        | 4.0  | 6.4      |               |
| $V_{DD2}$   |           | $V_I = 1(\text{Bx}), 0(\text{Ex})$ | —                        | 4.8  | 7.7      |               |
| <b>Notes:</b>   |           |                                    |                          |      |          |               |
| 1. The nominal output impedance of an isolator driver channel is approximately 50 $\Omega$ , $\pm 40\%$ , which is a combination of the value of the on-chip series termination resistor and channel resistance of the output driver FET. When driving loads where transmission line effects will be a factor, output pins should be appropriately terminated with controlled impedance PCB traces. |           |                                    |                          |      |          |               |
| 2. $t_{PSK(P-P)}$ is the magnitude of the difference in propagation delay times measured between different units operating at the same supply voltages, load, and ambient temperature.  |           |                                    |                          |      |          |               |
| 3. Start-up time is the time period from the application of power to valid data at the output.  |           |                                    |                          |      |          |               |

**Table 4. Electrical Characteristics (Continued)**

( $V_{DD1} = 2.5\text{ V} \pm 5\%$ ,  $V_{DD2} = 2.5\text{ V} \pm 5\%$ ,  $T_A = -40\text{ to }125\text{ }^\circ\text{C}$ )

| Parameter   | Symbol | Test Condition | Min    | Typ        | Max        | Unit |
|---|--------|----------------|--------|------------|------------|------|
| <b>1 Mbps Supply Current (All inputs = 500 kHz square wave, CI = 15 pF on all outputs)</b>  |        |                |        |            |            |      |
| <b>Si8610Bx, Ex</b><br>$V_{DD1}$<br>$V_{DD2}$   |        |                | —<br>— | 1.2<br>0.9 | 2.0<br>1.5 | mA   |
| <b>Si8620Bx, Ex</b><br>$V_{DD1}$<br>$V_{DD2}$   |        |                | —<br>— | 2.1<br>1.6 | 3.1<br>2.4 | mA   |
| <b>Si8621Bx, Ex</b><br>$V_{DD1}$<br>$V_{DD2}$   |        |                | —<br>— | 1.9<br>1.9 | 2.9<br>2.9 | mA   |
| <b>Si8622Bx, Ex</b><br>$V_{DD1}$<br>$V_{DD2}$   |        |                | —<br>— | 3.4<br>4.2 | 5.1<br>6.2 | mA   |
| <b>10 Mbps Supply Current (All inputs = 5 MHz square wave, CI = 15 pF on all outputs)</b>   |        |                |        |            |            |      |
| <b>Si8610Bx, Ex</b><br>$V_{DD1}$<br>$V_{DD2}$   |        |                | —<br>— | 1.2<br>1.0 | 2.0<br>1.6 | mA   |
| <b>Si8620Bx, Ex</b><br>$V_{DD1}$<br>$V_{DD2}$   |        |                | —<br>— | 2.1<br>1.7 | 3.1<br>2.6 | mA   |
| <b>Si8621Bx, Ex</b><br>$V_{DD1}$<br>$V_{DD2}$   |        |                | —<br>— | 2.0<br>2.0 | 2.9<br>2.9 | mA   |
| <b>Si8622Bx, Ex</b><br>$V_{DD1}$<br>$V_{DD2}$   |        |                | —<br>— | 3.5<br>4.2 | 5.2<br>6.3 | mA   |
| <b>100 Mbps Supply Current (All inputs = 50 MHz square wave, CI = 15 pF on all outputs)</b>   |        |                |        |            |            |      |
| <b>Si8610Bx, Ex</b><br>$V_{DD1}$<br>$V_{DD2}$   |        |                | —<br>— | 1.2<br>2.7 | 2.0<br>4.4 | mA   |
| <b>Si8620Bx, Ex</b><br>$V_{DD1}$<br>$V_{DD2}$   |        |                | —<br>— | 2.1<br>5.1 | 3.1<br>7.1 | mA   |
| <b>Si8621Bx, Ex</b><br>$V_{DD1}$<br>$V_{DD2}$   |        |                | —<br>— | 3.7<br>3.7 | 5.2<br>5.2 | mA   |
| <b>Si8622Bx, Ex</b><br>$V_{DD1}$<br>$V_{DD2}$   |        |                | —<br>— | 5.2<br>6.0 | 7.3<br>8.4 | mA   |
| <b>Notes:</b>   |        |                |        |            |            |      |
| <ol style="list-style-type: none"> <li>1. The nominal output impedance of an isolator driver channel is approximately <math>50\ \Omega</math>, <math>\pm 40\%</math>, which is a combination of the value of the on-chip series termination resistor and channel resistance of the output driver FET. When driving loads where transmission line effects will be a factor, output pins should be appropriately terminated with controlled impedance PCB traces.</li> <li>2. <math>t_{PSK(P-P)}</math> is the magnitude of the difference in propagation delay times measured between different units operating at the same supply voltages, load, and ambient temperature.</li> <li>3. Start-up time is the time period from the application of power to valid data at the output.</li> </ol> |        |                |        |            |            |      |

**Table 4. Electrical Characteristics (Continued)** $(V_{DD1} = 2.5\text{ V} \pm 5\%, V_{DD2} = 2.5\text{ V} \pm 5\%, T_A = -40\text{ to }125\text{ }^\circ\text{C})$ 

| Parameter   | Symbol             | Test Condition                       | Min | Typ | Max | Unit        |
|---|--------------------|--------------------------------------|-----|-----|-----|-------------|
| <b>Timing Characteristics</b>   |                    |                                      |     |     |     |             |
| <b>Si861x/2x Bx, Ex</b>   |                    |                                      |     |     |     |             |
| Maximum Data Rate   |                    |                                      | 0   | —   | 150 | Mbps        |
| Minimum Pulse Width   |                    |                                      | —   | —   | 5.0 | ns          |
| Propagation Delay   | $t_{PHL}, t_{PLH}$ | See Figure 1                         | 5.0 | 8.0 | 14  | ns          |
| Pulse Width Distortion<br>$ t_{PLH} - t_{PHL} $   | PWD                | See Figure 1                         | —   | 0.2 | 5.0 | ns          |
| Propagation Delay Skew <sup>2</sup>   | $t_{PSK(P-P)}$     |                                      | —   | 2.0 | 5.0 | ns          |
| Channel-Channel Skew  | $t_{PSK}$          |                                      | —   | 0.4 | 2.5 | ns          |
| <b>All Models</b>   |                    |                                      |     |     |     |             |
| Output Rise Time  | $t_r$              | $C_L = 15\text{ pF}$<br>See Figure 1 | —   | 2.5 | 4.0 | ns          |
| Output Fall Time  | $t_f$              | $C_L = 15\text{ pF}$<br>See Figure 1 | —   | 2.5 | 4.0 | ns          |
| Peak Eye Diagram Jitter   | $t_{JIT(PK)}$      | See Figure 6                         | —   | 350 | —   | ps          |
| Common Mode Transient Immunity  | CMTI               | $V_I = V_{DD}$ or 0 V                | 35  | 50  | —   | kV/ $\mu$ s |
| Start-Up Time <sup>3</sup>  | $t_{SU}$           |                                      | —   | 15  | 40  | $\mu$ s     |
| <b>Notes:</b>   |                    |                                      |     |     |     |             |
| <ol style="list-style-type: none"> <li>1. The nominal output impedance of an isolator driver channel is approximately <math>50\ \Omega</math>, <math>\pm 40\%</math>, which is a combination of the value of the on-chip series termination resistor and channel resistance of the output driver FET. When driving loads where transmission line effects will be a factor, output pins should be appropriately terminated with controlled impedance PCB traces.</li> <li>2. <math>t_{PSK(P-P)}</math> is the magnitude of the difference in propagation delay times measured between different units operating at the same supply voltages, load, and ambient temperature.</li> <li>3. Start-up time is the time period from the application of power to valid data at the output.</li> </ol> |                    |                                      |     |     |     |             |

**Table 5. Regulatory Information \***

|  |
|--|
| <b>CSA</b>   |
| The Si861x/2x is certified under CSA Component Acceptance Notice 5A. For more details, see File 232873.  |
| 61010-1: Up to 600 V <sub>RMS</sub> reinforced insulation working voltage; up to 600 V <sub>RMS</sub> basic insulation working voltage.  |
| 60950-1: Up to 600 V <sub>RMS</sub> reinforced insulation working voltage; up to 1000 V <sub>RMS</sub> basic insulation working voltage.   |
| 60601-1: Up to 125 V <sub>RMS</sub> reinforced insulation working voltage; up to 380 V <sub>RMS</sub> basic insulation working voltage.  |
| <b>VDE</b>   |
| The Si861x/2x is certified according to IEC 60747-5-2. For more details, see File 5006301-4880-0001.   |
| 60747-5-2: Up to 1200 V <sub>peak</sub> for basic insulation working voltage.  |
| 60950-1: Up to 600 V <sub>RMS</sub> reinforced insulation working voltage; up to 1000 V <sub>RMS</sub> basic insulation working voltage.   |
| <b>UL</b>  |
| The Si861x/2x is certified under UL1577 component recognition program. For more details, see File E257455.   |
| Rated up to 5000 V <sub>RMS</sub> isolation voltage for basic protection.  |
| <b>*Note:</b> Regulatory Certifications apply to 3.75 kV <sub>RMS</sub> rated devices which are production tested to 4.5 kV <sub>RMS</sub> for 1 sec.<br>Regulatory Certifications apply to 5.0 kV <sub>RMS</sub> rated devices which are production tested to 6.0 kV <sub>RMS</sub> for 1 sec.<br>For more information, see "6. Ordering Guide" on page 27. |

**Table 6. Insulation and Safety-Related Specifications**

| Parameter   | Symbol          | Test Condition | Value            |                  | Unit             |
|---|-----------------|----------------|------------------|------------------|------------------|
|   |                 |                | WB SOIC-16       | NB SOIC-8        |                  |
| Nominal Air Gap (Clearance) <sup>1</sup>          | L(IO1)          |                | 8.0              | 4.9              | mm               |
| Nominal External Tracking (Creepage) <sup>1</sup> | L(IO2)          |                | 8.0              | 4.01             | mm               |
| Minimum Internal Gap (Internal Clearance)         |                 |                | 0.014            | 0.011            | mm               |
| Tracking Resistance (Proof Tracking Index)        | PTI             | IEC60112       | 600              | 600              | V <sub>RMS</sub> |
| Erosion Depth                                     | ED              |                | 0.019            | 0.040            | mm               |
| Resistance (Input-Output) <sup>2</sup>            | R <sub>IO</sub> |                | 10 <sup>12</sup> | 10 <sup>12</sup> | Ω                |
| Capacitance (Input-Output) <sup>2</sup>           | C <sub>IO</sub> | f = 1 MHz      | 2.0              | 2.0              | pF               |
| Input Capacitance <sup>3</sup>                    | C <sub>I</sub>  |                | 4.0              | 4.0              | pF               |

**Notes:**

1. The values in this table correspond to the nominal creepage and clearance values as detailed in "7. Package Outline: 16-Pin Wide Body SOIC", "9. Package Outline: 8-Pin Narrow Body SOIC". VDE certifies the clearance and creepage limits as 8.5 mm minimum for the WB SOIC-16 package and 4.7 mm minimum for the NB SOIC-8 package. UL does not impose a clearance and creepage minimum for component level certifications. CSA certifies the clearance and creepage limits as 3.9 mm minimum for the NB SOIC-8 and 7.6 mm minimum for the WB SOIC-16 package.
2. To determine resistance and capacitance, the Si86xx is converted into a 2-terminal device. Pins 1–8 (1–4, NB SOIC-8) are shorted together to form the first terminal and pins 9–16 (5–8, NB SOIC-8) are shorted together to form the second terminal. The parameters are then measured between these two terminals.
3. Measured from input pin to ground.

Table 7. IEC 60664-1 (VDE 0844 Part 2) Ratings

| Parameter                   | Test Conditions                         | Specification |            |
|-----------------------------|---|---------------|------------|
|                             |   | NB SOIC-8     | WB SOIC-16 |
| Basic Isolation Group       | Material Group                          | I             | I          |
| Installation Classification | Rated Mains Voltages $\leq 150 V_{RMS}$ | I-IV          | I-IV       |
|                             | Rated Mains Voltages $\leq 300 V_{RMS}$ | I-III         | I-IV       |
|                             | Rated Mains Voltages $\leq 400 V_{RMS}$ | I-II          | I-III      |
|                             | Rated Mains Voltages $\leq 600 V_{RMS}$ | I-II          | I-III      |

Table 8. IEC 60747-5-2 Insulation Characteristics for Si86xxxx\*

| Parameter  | Symbol     | Test Condition   | Characteristic |           | Unit     |
|--|------------|--|----------------|-----------|----------|
|  |            |  | WB SOIC-16     | NB SOIC-8 |          |
| Maximum Working Insulation Voltage                   | $V_{IORM}$ |  | 1200           | 630       | Vpeak    |
| Input to Output Test Voltage                         | $V_{PR}$   | Method b1<br>( $V_{IORM} \times 1.875 = V_{PR}$ , 100%<br>Production Test, $t_m = 1$ sec,<br>Partial Discharge $< 5$ pC) | 2250           | 1182      |          |
| Transient Overvoltage                                | $V_{IOTM}$ | $t = 60$ sec   | 6000           | 6000      | Vpeak    |
| Pollution Degree<br>(DIN VDE 0110, Table 1)          |            |  | 2              | 2         |          |
| Insulation Resistance at $T_S$ ,<br>$V_{IO} = 500$ V | $R_S$      |  | $>10^9$        | $>10^9$   | $\Omega$ |

\*Note: Maintenance of the safety data is ensured by protective circuits. The Si86xxxx provides a climate classification of 40/125/21.

Table 9. IEC Safety Limiting Values<sup>1</sup>

| Parameter                                  | Symbol | Test Condition  | Min | Typ | Max        |           | Unit |
|--|--------|---|-----|-----|------------|-----------|------|
|  |        |   |     |     | WB SOIC-16 | NB SOIC-8 |      |
| Case Temperature                           | $T_S$  |   | —   | —   | 150        | 150       | °C   |
| Safety Input, Output,<br>or Supply Current | $I_S$  | $\theta_{JA} = 140$ °C/W (NB SOIC-8),<br>100 °C (WB SOIC-16),<br>$V_I = 5.5$ V, $T_J = 150$ °C, $T_A = 25$ °C | —   | —   | 220        | 160       | mA   |
| Device Power<br>Dissipation <sup>2</sup>   | $P_D$  |   | —   | —   | 150        | 150       | mW   |

**Notes:**

1. Maximum value allowed in the event of a failure; also see the thermal derating curve in Figures 2 and 3.
2. The Si86xx is tested with  $VDD1 = VDD2 = 5.5$  V,  $T_J = 150$  °C,  $CL = 15$  pF, input a 150 Mbps 50% duty cycle square wave.

**Table 10. Thermal Characteristics**

| Parameter                             | Symbol        | Test Condition | WB SOIC-16 | NB SOIC-8 | Unit                        |
|---------------------------------------|---------------|----------------|------------|-----------|-----------------------------|
| IC Junction-to-Air Thermal Resistance | $\theta_{JA}$ |                | 100        | 140       | $^{\circ}\text{C}/\text{W}$ |

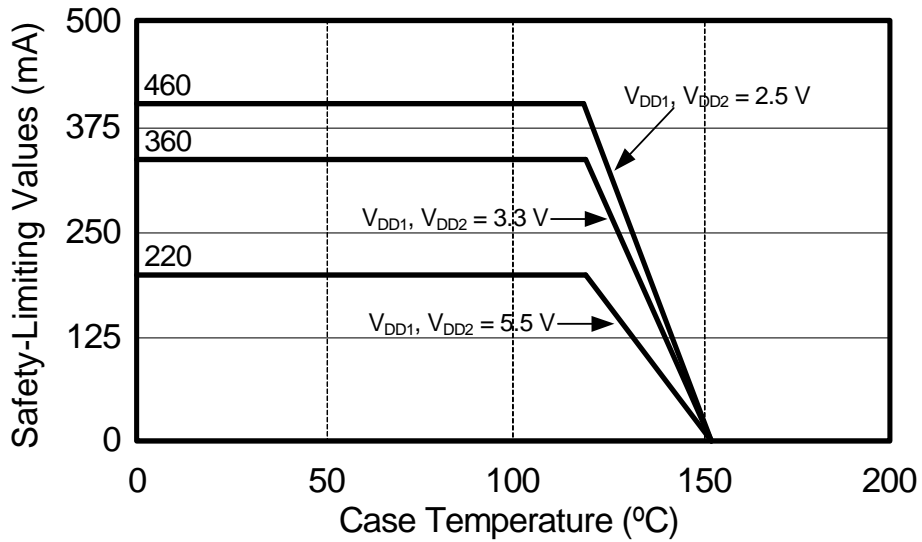

**Figure 2. (WB SOIC-16) Thermal Derating Curve, Dependence of Safety Limiting Values with Case Temperature per DIN EN 60747-5-2**

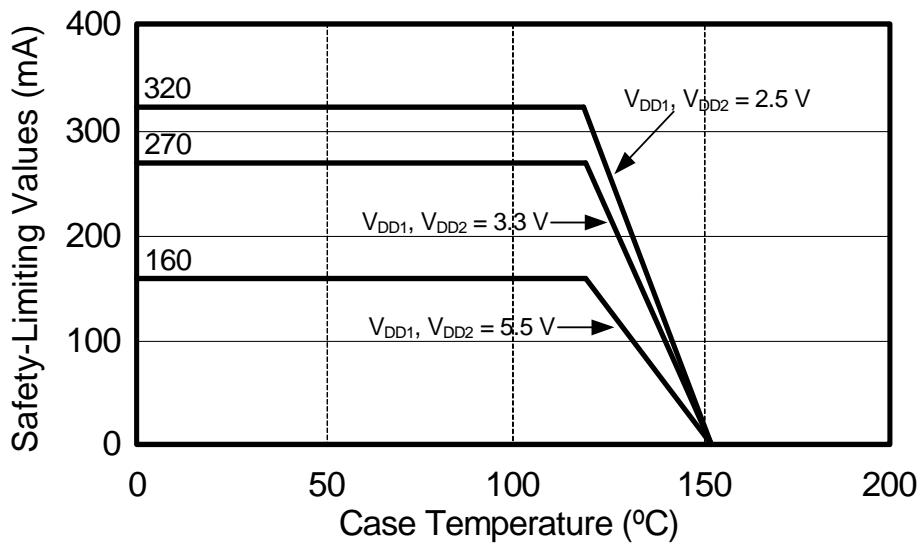

**Figure 3. (NB SOIC-8) Thermal Derating Curve, Dependence of Safety Limiting Values with Case Temperature per DIN EN 60747-5-2**



Table 11. Absolute Maximum Ratings<sup>1</sup>

| Parameter   | Symbol             | Min  | Typ | Max            | Unit      |
|---|--------------------|------|-----|----------------|-----------|
| Storage Temperature <sup>2</sup>                          | $T_{STG}$          | -65  | —   | 150            | °C        |
| Operating Temperature                                     | $T_A$              | -40  | —   | 125            | °C        |
| Junction Temperature                                      | $T_J$              | —    | —   | 150            | °C        |
| Supply Voltage  | $V_{DD1}, V_{DD2}$ | -0.5 | —   | 7.0            | V         |
| Input Voltage   | $V_I$              | -0.5 | —   | $V_{DD} + 0.5$ | V         |
| Output Voltage  | $V_O$              | -0.5 | —   | $V_{DD} + 0.5$ | V         |
| Output Current Drive Channel                              | $I_O$              | —    | —   | 10             | mA        |
| Lead Solder Temperature (10 s)                            |                    | —    | —   | 260            | °C        |
| Maximum Isolation (Input to Output) (1 sec)<br>NB SOIC-8  |                    | —    | —   | 4500           | $V_{RMS}$ |
| Maximum Isolation (Input to Output) (1 sec)<br>WB SOIC-16 |                    | —    | —   | 6500           | $V_{RMS}$ |

**Notes:**

1. Permanent device damage may occur if the absolute maximum ratings are exceeded. Functional operation should be restricted to conditions as specified in the operational sections of this data sheet.
2. VDE certifies storage temperature from -40 to 150 °C.

## 2. Functional Description

### 2.1. Theory of Operation

The operation of an Si861x/2x channel is analogous to that of an opto coupler, except an RF carrier is modulated instead of light. This simple architecture provides a robust isolated data path and requires no special considerations or initialization at start-up. A simplified block diagram for a single Si861x/2x channel is shown in Figure 4.

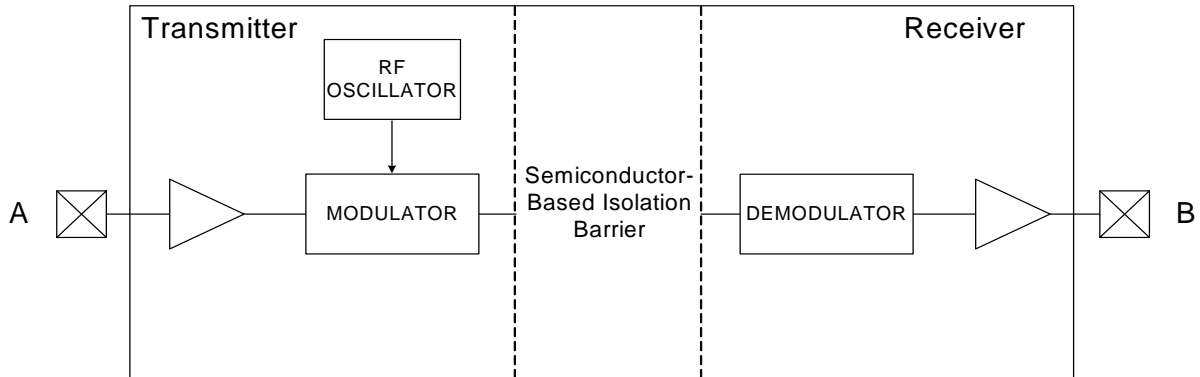

**Figure 4. Simplified Channel Diagram**

A channel consists of an RF Transmitter and RF Receiver separated by a semiconductor-based isolation barrier. Referring to the Transmitter, input A modulates the carrier provided by an RF oscillator using on/off keying. The Receiver contains a demodulator that decodes the input state according to its RF energy content and applies the result to output B via the output driver. This RF on/off keying scheme is superior to pulse code schemes as it provides best-in-class noise immunity, low power consumption, and better immunity to magnetic fields. See Figure 5 for more details.

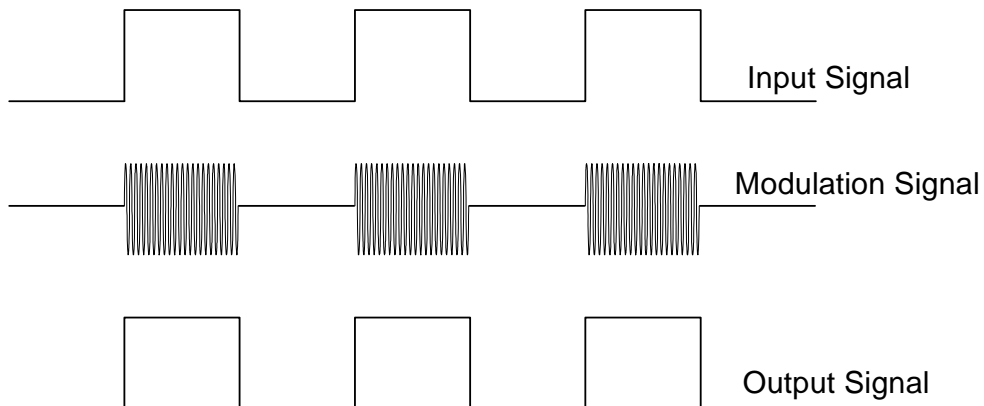

**Figure 5. Modulation Scheme**

## 2.2. Eye Diagram

Figure 6 illustrates an eye-diagram taken on an Si8610. For the data source, the test used an Anritsu (MP1763C) Pulse Pattern Generator set to 1000 ns/div. The output of the generator's clock and data from an Si8610 were captured on an oscilloscope. The results illustrate that data integrity was maintained even at the high data rate of 150 Mbps. The results also show that 2 ns pulse width distortion and 350 ps peak jitter were exhibited.

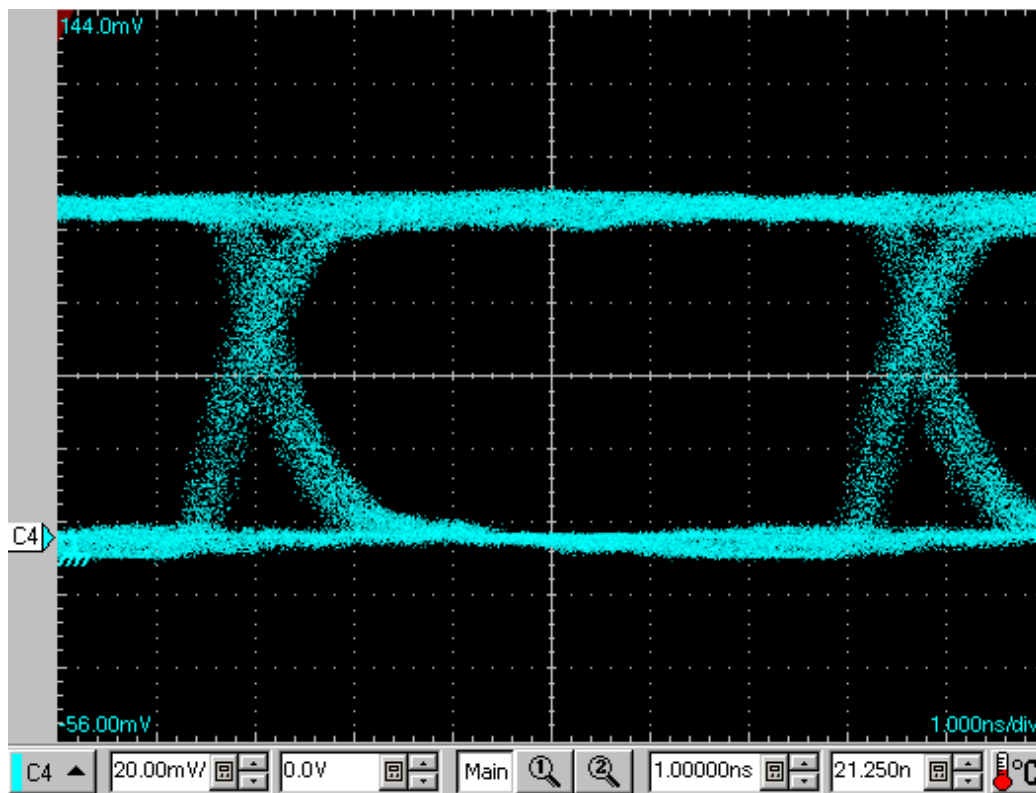

Figure 6. Eye Diagram

## 3. Device Operation

Device behavior during start-up, normal operation, and shutdown is shown in Figure 7, where UVLO+ and UVLO– are the positive-going and negative-going thresholds respectively. Refer to Table 12 to determine outputs when power supply (VDD) is not present.

**Table 12. Si86xx Logic Operation**

| V <sub>I</sub><br>Input <sup>1,2</sup> | VDDI<br>State <sup>1,3,4</sup> | VDDO<br>State <sup>1,3,4</sup> | V <sub>O</sub> Output <sup>1,2</sup> | Comments   |
|--|--------------------------------|--------------------------------|--------------------------------------|--|
| H                                      | P                              | P                              | H                                    | Normal operation.  |
| L                                      | P                              | P                              | L                                    |  |
| X <sup>5</sup>                         | UP                             | P                              | L <sup>6</sup><br>H <sup>6</sup>     | Upon transition of VDDI from unpowered to powered, V <sub>O</sub> returns to the same state as V <sub>I</sub> in less than 1 μs. |
| X <sup>5</sup>                         | P                              | UP                             | Undetermined                         | Upon transition of VDDO from unpowered to powered, V <sub>O</sub> returns to the same state as V <sub>I</sub> within 1 μs.       |

**Notes:**

1. VDDI and VDDO are the input and output power supplies. V<sub>I</sub> and V<sub>O</sub> are the respective input and output terminals.
2. X = not applicable; H = Logic High; L = Logic Low; Hi-Z = High Impedance.
3. "Powered" state (P) is defined as 2.5 V < VDD < 5.5 V.
4. "Unpowered" state (UP) is defined as VDD = 0 V.
5. Note that an I/O can power the die for a given side through an internal diode if its source has adequate current.
6. See "6. Ordering Guide" on page 27 for details. This is the selectable fail-safe operating mode (ordering option). Some devices have default output state = H, and some have default output state = L, depending on the ordering part number (OPN). For default high devices, the data channels have pull-ups on inputs/outputs. For default low devices, the data channels have pull-downs on inputs/outputs.

### 3.1. Device Startup

Outputs are held low during powerup until VDD is above the UVLO threshold for time period  $t_{START}$ . Following this, the outputs follow the states of inputs.

### 3.2. Undervoltage Lockout

Undervoltage Lockout (UVLO) is provided to prevent erroneous operation during device startup and shutdown or when VDD is below its specified operating circuits range. Both Side A and Side B each have their own undervoltage lockout monitors. Each side can enter or exit UVLO independently. For example, Side A unconditionally enters UVLO when  $V_{DD1}$  falls below  $V_{DD1(UVLO-)}$  and exits UVLO when  $V_{DD1}$  rises above  $V_{DD1(UVLO+)}$ . Side B operates the same as Side A with respect to its  $V_{DD2}$  supply.

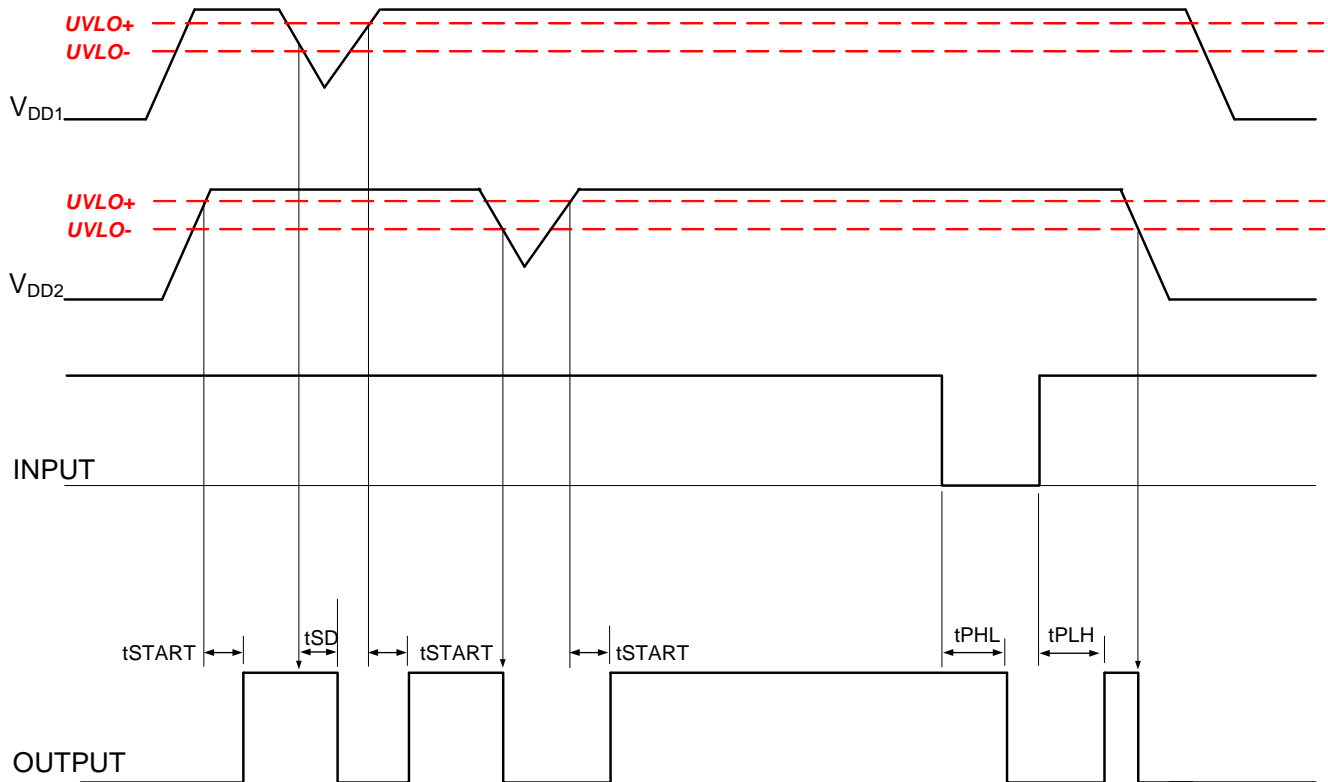

Figure 7. Device Behavior during Normal Operation

### 3.3. Layout Recommendations

To ensure safety in the end user application, high voltage circuits (i.e., circuits with  $>30 V_{AC}$ ) must be physically separated from the safety extra-low voltage circuits (SELV is a circuit with  $<30 V_{AC}$ ) by a certain distance (creepage/clearance). If a component, such as a digital isolator, straddles this isolation barrier, it must meet those creepage/clearance requirements and also provide a sufficiently large high-voltage breakdown protection rating (commonly referred to as working voltage protection). Table 5 on page 14 and Table 6 on page 14 detail the working voltage and creepage/clearance capabilities of the Si86xx. These tables also detail the component standards (UL1577, IEC60747, CSA 5A), which are readily accepted by certification bodies to provide proof for end-system specifications requirements. Refer to the end-system specification (61010-1, 60950-1, 60601-1, etc.) requirements before starting any design that uses a digital isolator.

#### 3.3.1. Supply Bypass

The Si861x/2x family requires a 0.1  $\mu F$  bypass capacitor between  $V_{DD1}$  and GND1 and  $V_{DD2}$  and GND2. The capacitor should be placed as close as possible to the package. To enhance the robustness of a design, the user may also include resistors (50–300  $\Omega$ ) in series with the inputs and outputs if the system is excessively noisy.

#### 3.3.2. Output Pin Termination

The nominal output impedance of an isolator driver channel is approximately 50  $\Omega$ ,  $\pm 40\%$ , which is a combination of the value of the on-chip series termination resistor and channel resistance of the output driver FET. When driving loads where transmission line effects will be a factor, output pins should be appropriately terminated with controlled impedance PCB traces.

### 3.4. Fail-Safe Operating Mode

Si86xx devices feature a selectable (by ordering option) mode whereby the default output state (when the input supply is unpowered) can either be a logic high or logic low when the output supply is powered. See Table 12 on page 20 and "6. Ordering Guide" on page 27 for more information.

## 3.5. Typical Performance Characteristics

The typical performance characteristics depicted in the following diagrams are for information purposes only. Refer to Tables 2, 3, and 4 for actual specification limits.

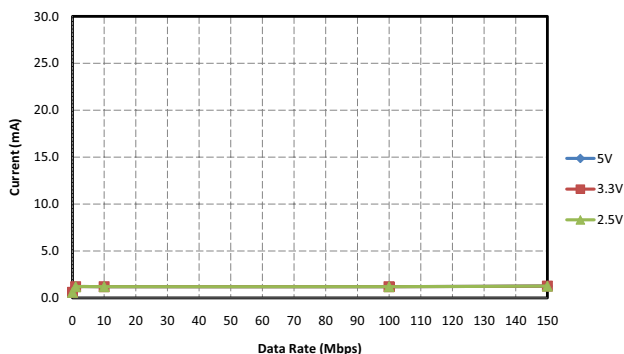

**Figure 8. Si8610 Typical  $V_{DD1}$  Supply Current vs. Data Rate 5, 3.3, and 2.70 V Operation**

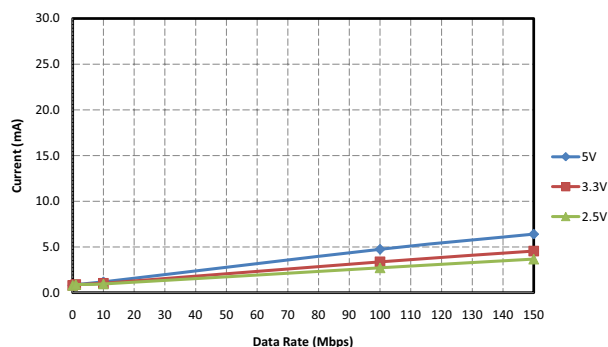

**Figure 11. Si8610 Typical  $V_{DD2}$  Supply Current vs. Data Rate 5, 3.3, and 2.70 V Operation (15 pF Load)**

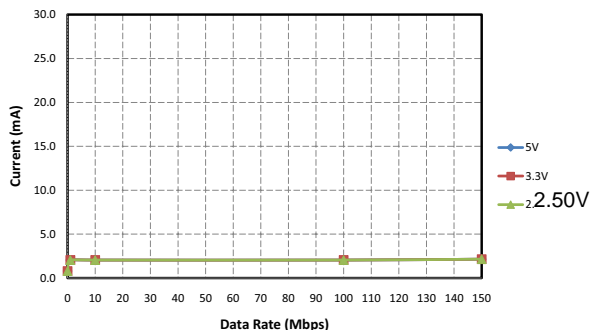

**Figure 9. Si8620 Typical  $V_{DD1}$  Supply Current vs. Data Rate 5, 3.3, and 2.70 V Operation**

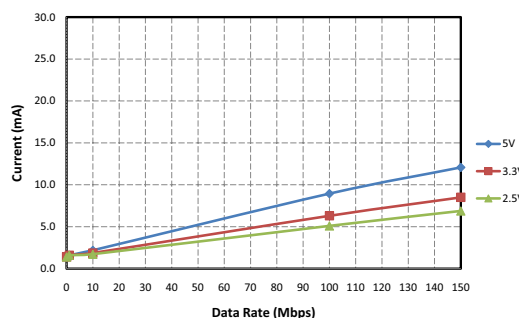

**Figure 12. Si8620 Typical  $V_{DD2}$  Supply Current vs. Data Rate 5, 3.3, and 2.70 V Operation (15 pF Load)**

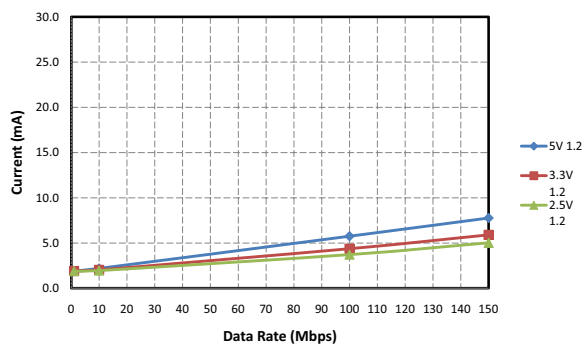

**Figure 10. Si8621 Typical  $V_{DD1}$  or  $V_{DD2}$  Supply Current vs. Data Rate 5, 3.3, and 2.70 V Operation (15 pF Load)**

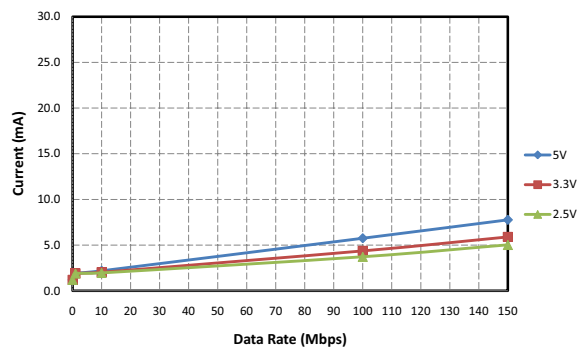

**Figure 13. Si8622 Typical  $V_{DD1}$  or  $V_{DD2}$  Supply Current vs. Data Rate 5, 3.3, and 2.70 V Operation (15 pF Load)**

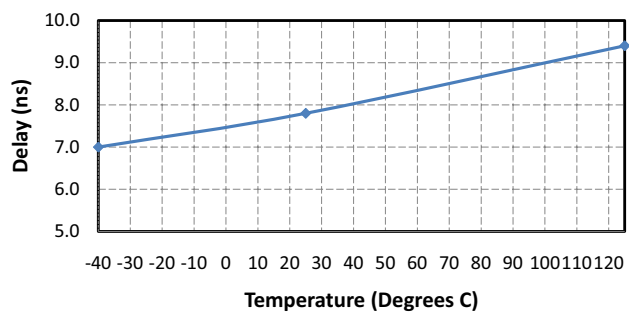

**Figure 14. Propagation Delay vs. Temperature**



## 4. Pin Descriptions (Wide-Body SOIC)

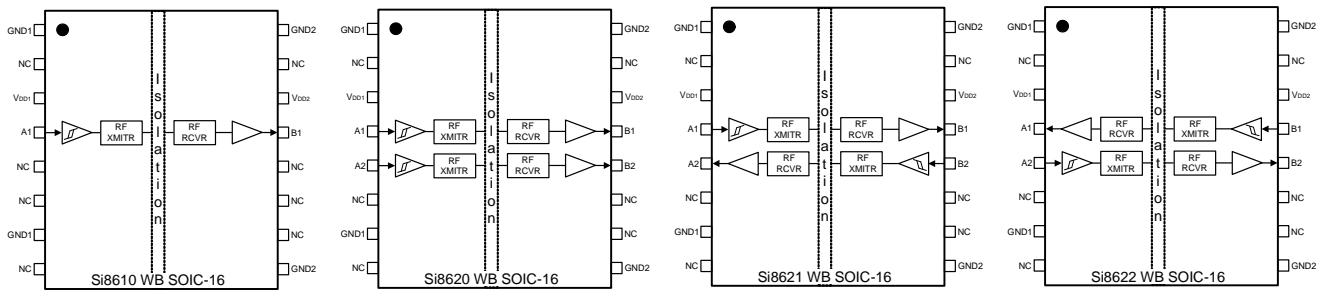

| Name             | SOIC-16 Pin#<br>Si8610        | SOIC-16 Pin#<br>Si862x | Type        | Description                     |
|------------------|-------------------------------|------------------------|-------------|---------------------------------|
| GND1             | 1                             | 1                      | Ground      | Side 1 ground.                  |
| NC*              | 2, 5, 6, 8, 10,<br>11, 12, 15 | 2, 6, 8, 10,<br>11, 15 | No Connect  | NC                              |
| V <sub>DD1</sub> | 3                             | 3                      | Supply      | Side 1 power supply.            |
| A1               | 4                             | 4                      | Digital I/O | Side 1 digital input or output. |
| A2               | NC                            | 5                      | Digital I/O | Side 1 digital input or output. |
| GND1             | 7                             | 7                      | Ground      | Side 1 ground.                  |
| GND2             | 9                             | 9                      | Ground      | Side 2 ground.                  |
| B2               | NC                            | 12                     | Digital I/O | Side 2 digital input or output. |
| B1               | 13                            | 13                     | Digital I/O | Side 2 digital input or output. |
| V <sub>DD2</sub> | 14                            | 14                     | Supply      | Side 2 power supply.            |
| GND2             | 16                            | 16                     | Ground      | Side 2 ground.                  |

**\*Note:** No Connect. These pins are not internally connected. They can be left floating, tied to V<sub>DD</sub>, or tied to GND.

## 5. Pin Descriptions (Narrow-Body SOIC)

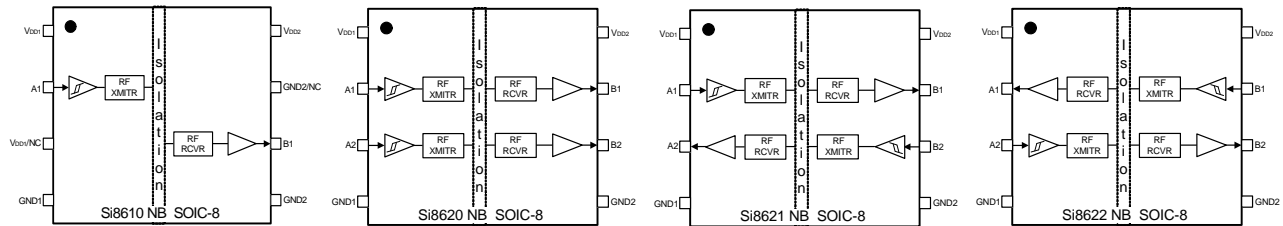

| Name                  | SOIC-8 Pin#<br>Si861x | SOIC-8 Pin#<br>Si862x | Type        | Description                     |
|-----------------------|-----------------------|-----------------------|-------------|---------------------------------|
| V <sub>DD1</sub> /NC* | 1,3                   | 1                     | Supply      | Side 1 power supply.            |
| GND1                  | 4                     | 4                     | Ground      | Side 1 ground.                  |
| A1                    | 2                     | 2                     | Digital I/O | Side 1 digital input or output. |
| A2                    | NA                    | 3                     | Digital I/O | Side 1 digital input or output. |
| B1                    | 6                     | 7                     | Digital I/O | Side 2 digital input or output. |
| B2                    | NA                    | 6                     | Digital I/O | Side 2 digital input or output. |
| V <sub>DD2</sub>      | 8                     | 8                     | Supply      | Side 2 power supply.            |
| GND2/NC*              | 5,7                   | 5                     | Ground      | Side 2 ground.                  |

**\*Note:** No connect. These pins are not internally connected. They can be left floating, tied to VDD, or tied to GND.

## 6. Ordering Guide

Table 13. Ordering Guide for Valid OPNs<sup>1,2</sup>

| Ordering Part Number (OPN) | Number of Inputs VDD1 Side | Number of Inputs VDD2 Side | Max Data Rate (Mbps) | Default Output State | Isolation rating (kV) | Temp (C)      | Package    |
|----------------------------|----------------------------|----------------------------|----------------------|----------------------|-----------------------|---------------|------------|
| Si8610BC-B-IS              | 1                          | 0                          | 150 Mbps             | Low                  | 3.75                  | -40 to 125 °C | SOIC-8     |
| Si8610EC-B-IS              | 1                          | 0                          | 150 Mbps             | High                 | 3.75                  | -40 to 125 °C | SOIC-8     |
| Si8610BD-B-IS              | 1                          | 0                          | 150 Mbps             | Low                  | 5.0                   | -40 to 125 °C | WB SOIC-16 |
| Si8610ED-B-IS              | 1                          | 0                          | 150 Mbps             | High                 | 5.0                   | -40 to 125 °C | WB SOIC-16 |
| Si8620BC-B-IS              | 2                          | 0                          | 150 Mbps             | Low                  | 3.75                  | -40 to 125 °C | SOIC-8     |
| Si8620EC-B-IS              | 2                          | 0                          | 150 Mbps             | High                 | 3.75                  | -40 to 125 °C | SOIC-8     |
| Si8620BD-B-IS              | 2                          | 0                          | 150 Mbps             | Low                  | 5.0                   | -40 to 125 °C | WB SOIC-16 |
| Si8620ED-B-IS              | 2                          | 0                          | 150 Mbps             | High                 | 5.0                   | -40 to 125 °C | WB SOIC-16 |
| Si8621BC-B-IS              | 1                          | 1                          | 150 Mbps             | Low                  | 3.75                  | -40 to 125 °C | SOIC-8     |
| Si8621EC-B-IS              | 1                          | 1                          | 150 Mbps             | High                 | 3.75                  | -40 to 125 °C | SOIC-8     |
| Si8621BD-B-IS              | 1                          | 1                          | 150 Mbps             | Low                  | 5.0                   | -40 to 125 °C | WB SOIC-16 |
| Si8621ED-B-IS              | 1                          | 1                          | 150 Mbps             | High                 | 5.0                   | -40 to 125 °C | WB SOIC-16 |
| Si8622BC-B-IS              | 1                          | 1                          | 150 Mbps             | Low                  | 3.75                  | -40 to 125 °C | SOIC-8     |
| Si8622EC-B-IS              | 1                          | 1                          | 150 Mbps             | High                 | 3.75                  | -40 to 125 °C | SOIC-8     |
| Si8622BD-B-IS              | 1                          | 1                          | 150 Mbps             | Low                  | 5.0                   | -40 to 125 °C | WB SOIC-16 |
| Si8622ED-B-IS              | 1                          | 1                          | 150 Mbps             | High                 | 5.0                   | -40 to 125 °C | WB SOIC-16 |

**Notes:**

- All packages are RoHS-compliant with peak reflow temperatures of 260 °C according to the JEDEC industry standard classifications and peak solder temperatures.  
Moisture sensitivity level is MSL3 for wide-body SOIC-16 packages.  
Moisture sensitivity level is MSL2A for narrow-body SOIC-8 packages.
- All devices >1 kV<sub>RMS</sub> are AEC-Q100 qualified.

## 7. Package Outline: 16-Pin Wide Body SOIC

Figure 15 illustrates the package details for the Triple-Channel Digital Isolator. Table 14 lists the values for the dimensions shown in the illustration.

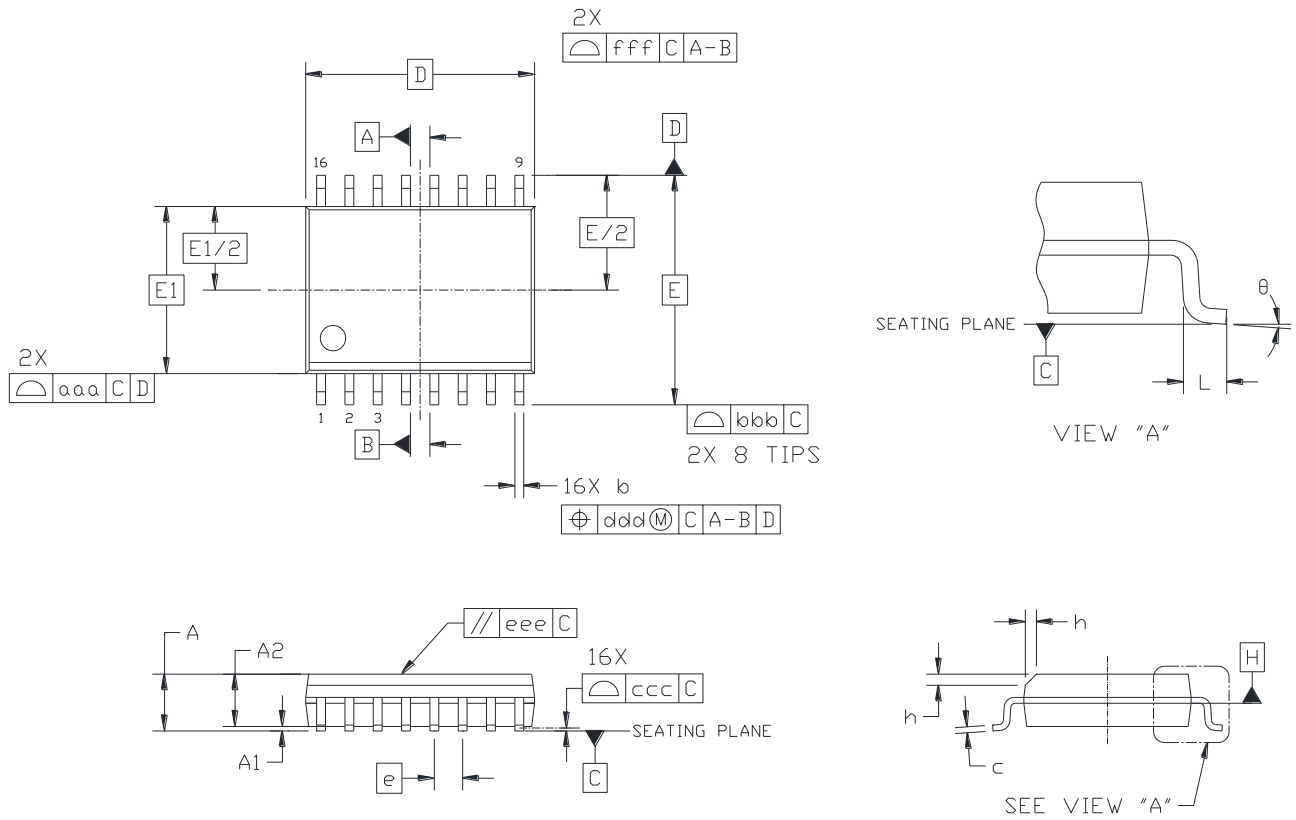

**Figure 15. 16-Pin Wide Body SOIC**

Table 14. Package Diagram Dimensions

| Dimension | Min       | Max  |
|-----------|-----------|------|
| A         | —         | 2.65 |
| A1        | 0.10      | 0.30 |
| A2        | 2.05      | —    |
| b         | 0.31      | 0.51 |
| c         | 0.20      | 0.33 |
| D         | 10.30 BSC |      |
| E         | 10.30 BSC |      |
| E1        | 7.50 BSC  |      |
| e         | 1.27 BSC  |      |
| L         | 0.40      | 1.27 |
| h         | 0.25      | 0.75 |
| $\theta$  | 0°        | 8°   |
| aaa       | —         | 0.10 |
| bbb       | —         | 0.33 |
| ccc       | —         | 0.10 |
| ddd       | —         | 0.25 |
| eee       | —         | 0.10 |
| fff       | —         | 0.20 |

**Notes:**

1. All dimensions shown are in millimeters (mm) unless otherwise noted.
2. Dimensioning and Tolerancing per ANSI Y14.5M-1994.
3. This drawing conforms to JEDEC Outline MS-013, Variation AA.
4. Recommended reflow profile per JEDEC J-STD-020C specification for small body, lead-free components.

## 8. Land Pattern: 16-Pin Wide-Body SOIC

Figure 16 illustrates the recommended land pattern details for the Si861x/2x in a 16-pin wide-body SOIC. Table 15 lists the values for the dimensions shown in the illustration.



**Figure 16. 16-Pin SOIC Land Pattern**

**Table 15. 16-Pin Wide Body SOIC Land Pattern Dimensions**

| Dimension | Feature            | (mm) |
|-----------|--------------------|------|
| C1        | Pad Column Spacing | 9.40 |
| E         | Pad Row Pitch      | 1.27 |
| X1        | Pad Width          | 0.60 |
| Y1        | Pad Length         | 1.90 |

**Notes:**

1. This Land Pattern Design is based on IPC-7351 pattern SOIC127P1032X265-16AN for Density Level B (Median Land Protrusion).
2. All feature sizes shown are at Maximum Material Condition (MMC) and a card fabrication tolerance of 0.05 mm is assumed.

### 9. Package Outline: 8-Pin Narrow Body SOIC

Figure 17 illustrates the package details for the Si86xx. Table 16 lists the values for the dimensions shown in the illustration.

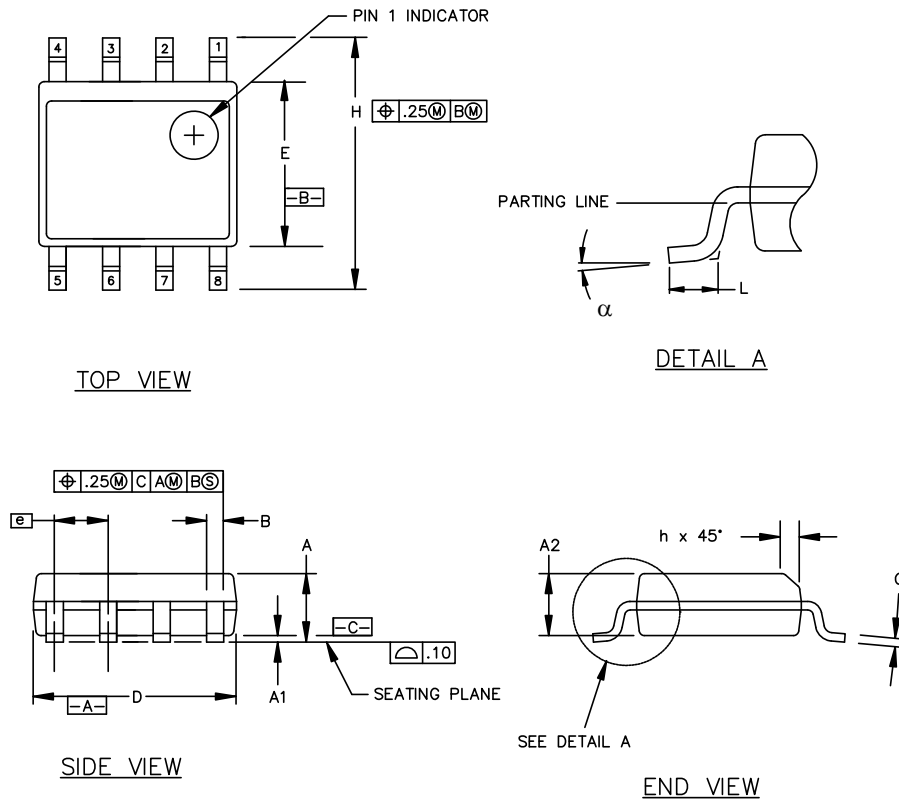

Figure 17. 8-pin Small Outline Integrated Circuit (SOIC) Package

Table 16. Package Diagram Dimensions

| Symbol   | Millimeters |          |
|----------|-------------|----------|
|          | Min         | Max      |
| A        | 1.35        | 1.75     |
| A1       | 0.10        | 0.25     |
| A2       | 1.40 REF    | 1.55 REF |
| B        | 0.33        | 0.51     |
| C        | 0.19        | 0.25     |
| D        | 4.80        | 5.00     |
| E        | 3.80        | 4.00     |
| e        | 1.27 BSC    |          |
| H        | 5.80        | 6.20     |
| h        | 0.25        | 0.50     |
| L        | 0.40        | 1.27     |
| $\alpha$ | 0°          | 8°       |

## 10. Land Pattern: 8-Pin Narrow Body SOIC

Figure 18 illustrates the recommended land pattern details for the Si86xx in an 8-pin narrow-body SOIC. Table 17 lists the values for the dimensions shown in the illustration.

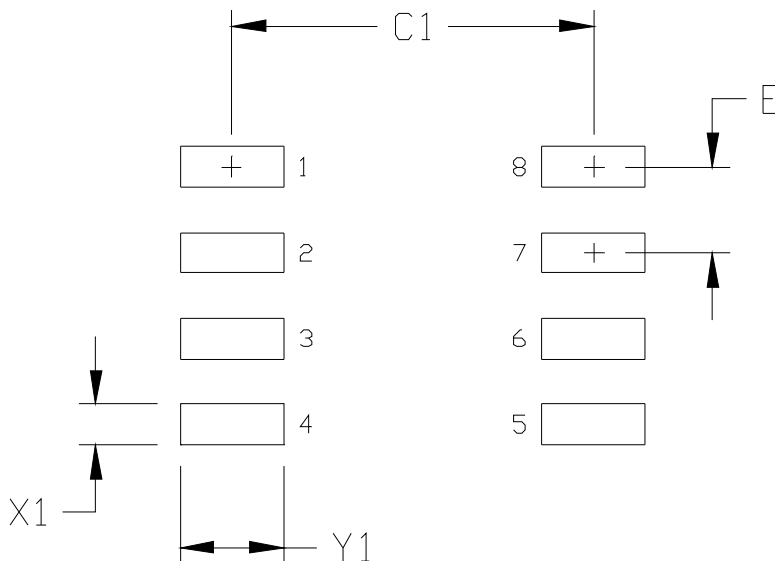

**Figure 18. PCB Land Pattern: 8-Pin Narrow Body SOIC**

**Table 17. PCM Land Pattern Dimensions (8-Pin Narrow Body SOIC)**

| Dimension | Feature            | (mm) |
|-----------|--------------------|------|
| C1        | Pad Column Spacing | 5.40 |
| E         | Pad Row Pitch      | 1.27 |
| X1        | Pad Width          | 0.60 |
| Y1        | Pad Length         | 1.55 |

**Notes:**

1. This Land Pattern Design is based on IPC-7351 pattern SOIC127P600X173-8N for Density Level B (Median Land Protrusion).
2. All feature sizes shown are at Maximum Material Condition (MMC) and a card fabrication tolerance of 0.05 mm is assumed.



## 11. Top Marking: 16-Pin Wide Body SOIC

### 11.1. 16-Pin Wide Body SOIC Top Marking

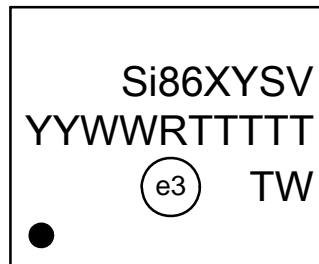

### 11.2. Top Marking Explanation

|                        |  |  |
|------------------------|--|--|
| <b>Line 1 Marking:</b> | Base Part Number<br>Ordering Options<br><br>(See Ordering Guide for more information). | Si86 = Isolator product series<br>XY = Channel Configuration<br>X = # of data channels (2, 1)<br>Y = # of reverse channels (1, 0)<br>S = Speed Grade (max data rate) and operating mode:<br>A = 1 Mbps (default output = low)<br>B = 150 Mbps (default output = low)<br>D = 1 Mbps (default output = high)<br>E = 150 Mbps (default output = high)<br>V = Insulation rating<br>A = 1 kV; B = 2.5 kV; C = 3.75 kV; D = 5.0 kV |
| <b>Line 2 Marking:</b> | YY = Year<br>WW = Workweek   | Assigned by assembly subcontractor. Corresponds to the year and workweek of the mold date.   |
|                        | RTTTTT = Mfg Code  | Manufacturing code from assembly house<br>"R" indicates revision   |
| <b>Line 3 Marking:</b> | Circle = 1.5 mm Diameter<br>(Center-Justified)   | "e3" Pb-Free Symbol  |
|                        | Country of Origin ISO Code<br>Abbreviation   | TW = Taiwan  |

## 12. Top Marking: 8-Pin Narrow Body SOIC

### 12.1. 8-Pin Narrow Body SOIC Top Marking

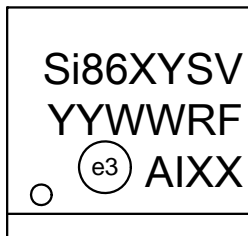

### 12.2. Top Marking Explanation

|                        |  |  |
|------------------------|--|--|
| <b>Line 1 Marking:</b> | Base Part Number<br>Ordering Options<br><br>(See Ordering Guide for more information).                             | Si86 = Isolator product series<br>XY = Channel Configuration<br>X = # of data channels (2, 1)<br>Y = # of reverse channels (1, 0)<br>S = Speed Grade (max data rate) and operating mode:<br>A = 1 Mbps (default output = low)<br>B = 150 Mbps (default output = low)<br>D = 1 Mbps (default output = high)<br>E = 150 Mbps (default output = high)<br>V = Insulation rating<br>A = 1 kV; B = 2.5 kV; C = 3.75 kV; D = 5 kV |
| <b>Line 2 Marking:</b> | YY = Year<br>WW = Workweek<br><br>R = Product (OPN) Revision<br>F = Wafer Fab                                      | Assigned by assembly subcontractor. Corresponds to the year and workweek of the mold date.   |
| <b>Line 3 Marking:</b> | Circle = 1.1 mm Diameter<br>Left-Justified<br><br>A = Assembly Site<br>I = Internal Code<br>XX = Serial Lot Number | "e3" Pb-Free Symbol.<br>First two characters of the manufacturing code.<br><br>Last four characters of the manufacturing code.   |

## DOCUMENT CHANGE LIST

### Revision 0.1 to Revision 0.2

- Added chip graphics on page 1.
- Moved Tables 1 and 11 to page 17.
- Updated Table 6, "Insulation and Safety-Related Specifications," on page 14.
- Updated Table 8, "IEC 60747-5-2 Insulation Characteristics for Si86xxxx\*," on page 15.
- Moved Table 12 to page 20.
- Moved "Typical Performance Characteristics" to page 23.
- Updated "4. Pin Descriptions (Wide-Body SOIC)" on page 25.
- Updated "5. Pin Descriptions (Narrow-Body SOIC)" on page 26.
- Updated "6. Ordering Guide" on page 27.

### Revision 0.2 to Revision 0.3

- Added chip graphics on page 1.
- Moved Tables 1 and 2 to page 17.
- Updated Table 6, "Insulation and Safety-Related Specifications," on page 14.
- Updated Table 8, "IEC 60747-5-2 Insulation Characteristics for Si86xxxx\*," on page 15.
- Moved Table 12 to page 20.
- Moved Table 13 to page 27.
- Moved "Typical Performance Characteristics" to page 23.
- Updated "4. Pin Descriptions (Wide-Body SOIC)" on page 25.
- Updated "5. Pin Descriptions (Narrow-Body SOIC)" on page 26.
- Updated "6. Ordering Guide" on page 27.

### Revision 0.3 to Revision 1.0

- Updated "Table 3. Electrical Characteristics".
- Reordered spec tables to conform to new convention.
- Removed "pending" throughout document.

### Revision 1.0 to Revision 1.1

- Updated High Level Output Voltage V<sub>OH</sub> to 3.1 V in Table 3, "Electrical Characteristics," on page 8.
- Updated High Level Output Voltage V<sub>OH</sub> to 2.3 V in Table 4, "Electrical Characteristics," on page 11.

### Revision 1.1 to Revision 1.2

- Updated Table 12 on page 20.
  - Deleted reference to EN.
- Updated "6. Ordering Guide" on page 27 to include MSL2A.

### Revision 1.2 to Revision 1.3

- Updated Table 11 on page 17.
  - Added junction temperature spec.
- Updated "3.3.1. Supply Bypass" on page 22.
- Removed "3.3.2. Pin Connections" on page 22.
- Updated "6. Ordering Guide" on page 27.
  - Removed Rev A devices.
- Updated "7. Package Outline: 16-Pin Wide Body SOIC" on page 28.
- Updated Top Marks.
  - Added revision description.

## CONTACT INFORMATION

### Silicon Laboratories Inc.

400 West Cesar Chavez  
Austin, TX 78701  
Tel: 1+(512) 416-8500  
Fax: 1+(512) 416-9669  
Toll Free: 1+(877) 444-3032

Please visit the Silicon Labs Technical Support web page:  
<https://www.silabs.com/support/pages/contacttechnicalsupport.aspx>  
and register to submit a technical support request.

The information in this document is believed to be accurate in all respects at the time of publication but is subject to change without notice. Silicon Laboratories assumes no responsibility for errors and omissions, and disclaims responsibility for any consequences resulting from the use of information included herein. Additionally, Silicon Laboratories assumes no responsibility for the functioning of undescribed features or parameters. Silicon Laboratories reserves the right to make changes without further notice. Silicon Laboratories makes no warranty, representation or guarantee regarding the suitability of its products for any particular purpose, nor does Silicon Laboratories assume any liability arising out of the application or use of any product or circuit, and specifically disclaims any and all liability, including without limitation consequential or incidental damages. Silicon Laboratories products are not designed, intended, or authorized for use in applications intended to support or sustain life, or for any other application in which the failure of the Silicon Laboratories product could create a situation where personal injury or death may occur. Should Buyer purchase or use Silicon Laboratories products for any such unintended or unauthorized application, Buyer shall indemnify and hold Silicon Laboratories harmless against all claims and damages.

Silicon Laboratories and Silicon Labs are trademarks of Silicon Laboratories Inc.  
Other products or brandnames mentioned herein are trademarks or registered trademarks of their respective holders.