

Features

- Batch process design, excellent power dissipation offers better reverse leakage current and thermal resistance.
- Low profile surface mounted application in order to optimize board space.
- Tiny plastic SMD package.
- Low power loss, high efficiency.
- High current capability, low forward voltage drop.
- High surge capability.
- Guardring for overvoltage protection.
- Ultra high-speed switching.
- Silicon epitaxial planar chip, metal silicon junction.
- **Moisture Sensitivity Level 1**

Mechanical data

- Epoxy : UL94-V0 rated flame retardant
- Case : Molded plastic, SOD-123-L
- Terminals :Plated terminals, solderable per MIL-STD-750, Method 2026
- Polarity : Indicated by cathode band
- Mounting Position : Any
- Weight : Approximated 0.018 gram

Package outline

SOD-123-L

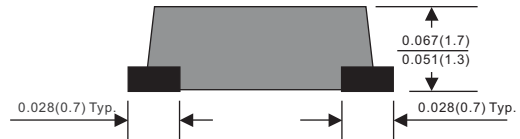
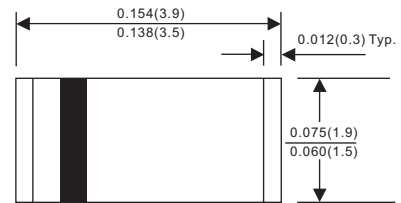

Dimensions in inches and (millimeters)

Maximum ratings and Electrical Characteristics (AT T_A=25°C unless otherwise noted)

PARAMETER	CONDITIONS	Symbol	MIN.	TYP.	MAX.	UNIT
Forward rectified current	See Fig.2	I _o			2.0	A
Forward surge current	8.3ms single half sine-wave superimposed on rate load (JEDEC methode)	I _{FSM}			50	A
Reverse current	V _R = V _{RRM} T _J = 25°C	I _R			1.0	mA
Diode junction capacitance	f=1MHz and applied 4V DC reverse voltage	C _J		160		pF
Storage temperature		T _{STG}	-55		+150	°C

SYMBOLS	V _{RRM} ^{*1} (V)	V _{RMS} ^{*2} (V)	V _R ^{*3} (V)	V _F ^{*4} (V)	Operating temperature T _J , (°C)
SL22-M	20	14	20	0.38	-55 to +100
SL24-M	40	28	40	0.40	

*1 Repetitive peak reverse voltage

*2 RMS voltage

*3 Continuous reverse voltage

*4 Maximum forward voltage@I_F=2.0A

Rating and characteristic curves

FIG.1-TYPICAL FORWARD CHARACTERISTICS

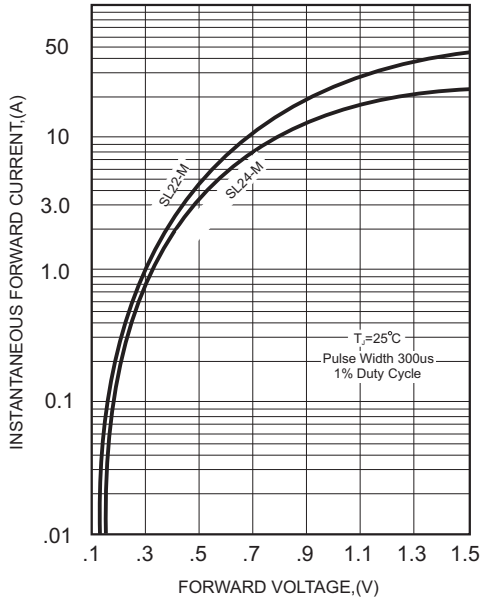

FIG.2-TYPICAL FORWARD CURRENT DERATING CURVE

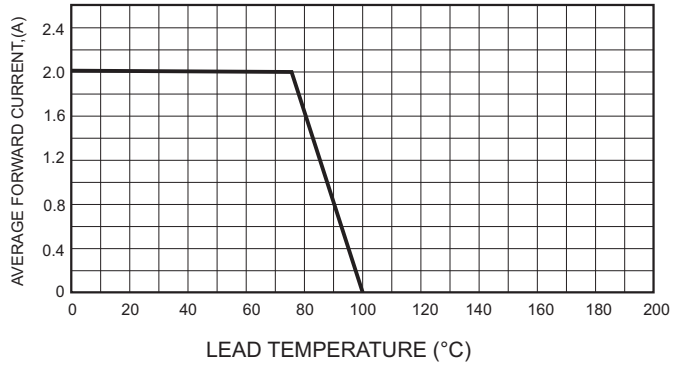

FIG.4-MAXIMUM NON-REPETITIVE FORWARD SURGE CURRENT

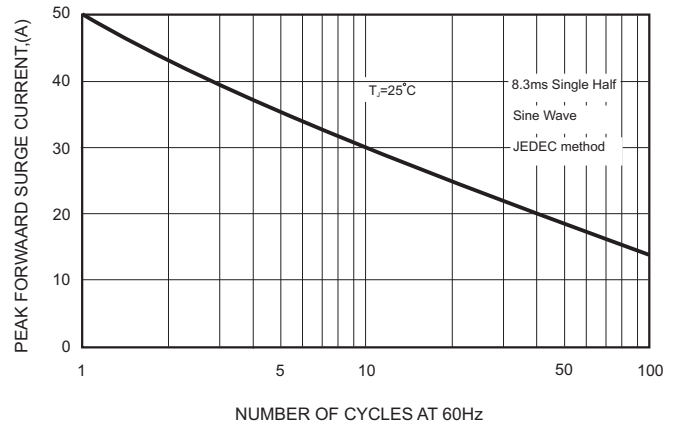

FIG.3 - TYPICAL REVERSE CHARACTERISTICS

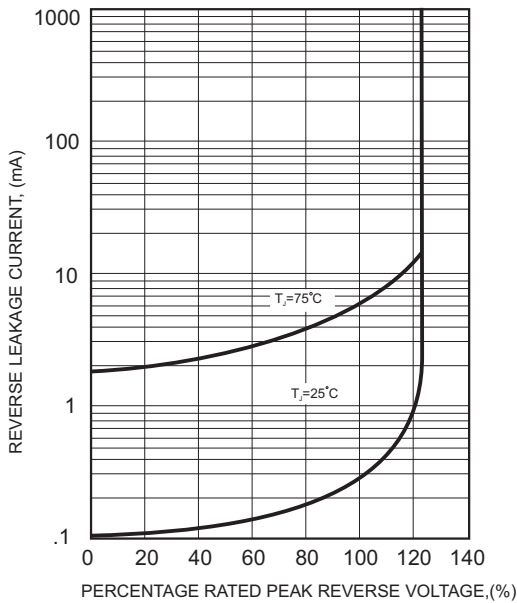
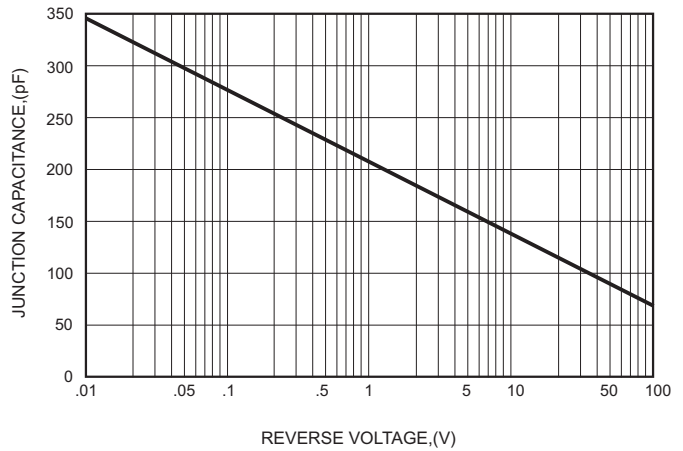



FIG.5-TYPICAL JUNCTION CAPACITANCE



Pinning information

Pin	Simplified outline	Symbol
Pin1 cathode Pin2 anode		

Reel packing

PACKAGE	REEL SIZE	REEL (pcs)	COMPONENT SPACING (m/m)	BOX (pcs)	INNER BOX (m/m)	REEL DIA, (m/m)	CARTON SIZE (m/m)	CARTON (pcs)	APPROX. GROSS WEIGHT (kg)
SOD-123-L	7"	2,500	4.0	25,000	183*183*123	178	382*262*387	200,000	9.5

Marking

Type number	Marking code
SL22-M-TH	L22
SL24-M-TH	L24

Note: M: Package code, SOD-123-L

-T: Taping Reel

Pb-Free package is available

RoHS product for packing code suffix "G"

Halogen free product for packing code suffix "H"

Suggested solder pad layout

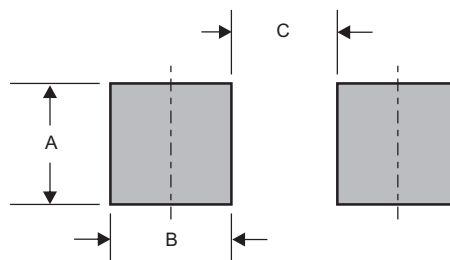

Dimensions in inches and (millimeters)

PACKAGE	A	B	C
SOD-123-L	0.075 (1.90)	0.055 (1.40)	0.075 (1.90)

Packing information

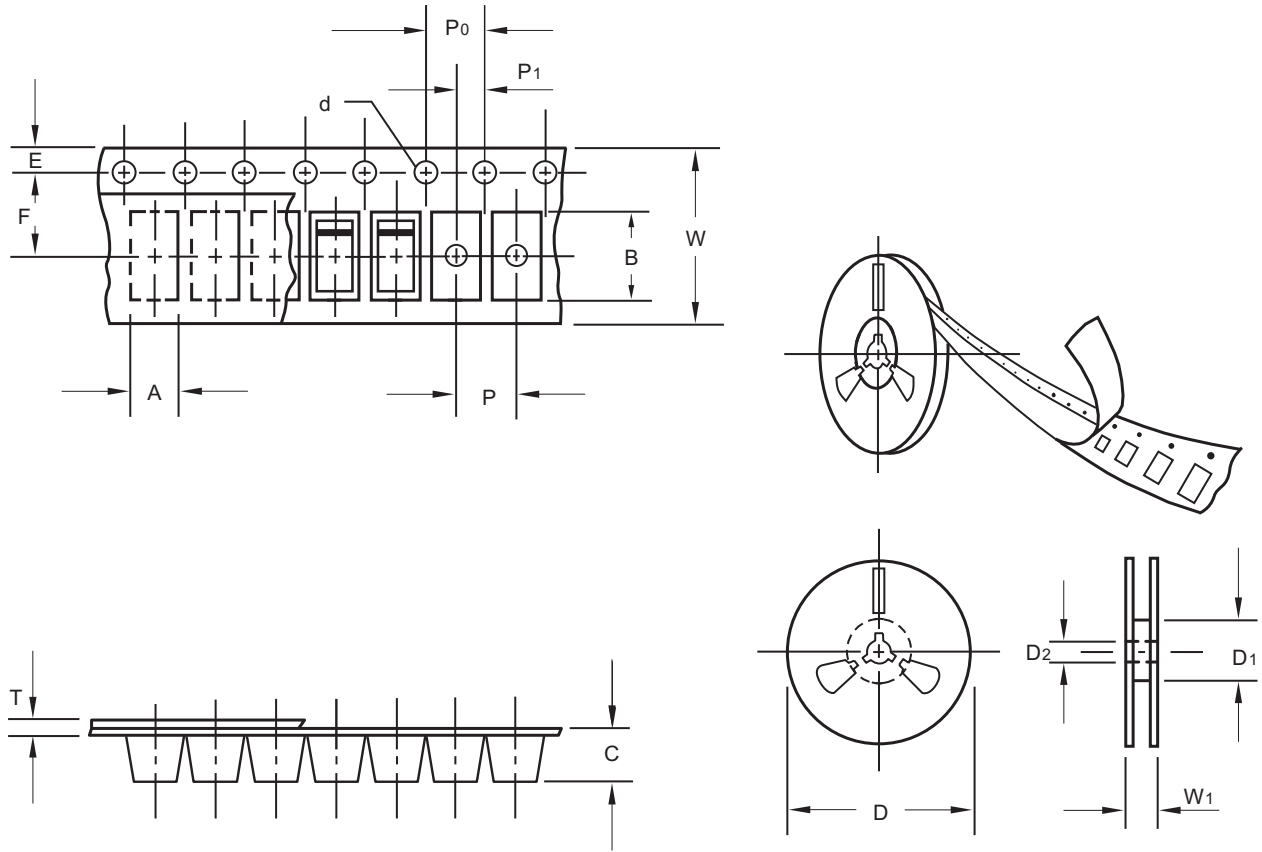

unit:mm

Item	Symbol	Tolerance	SOD-123-L
Carrier width	A	0.1	1.90
Carrier length	B	0.1	3.90
Carrier depth	C	0.1	1.68
Sprocket hole	d	0.1	1.50
13" Reel outside diameter	D	2.0	-
13" Reel inner diameter	D1	min	-
7" Reel outside diameter	D	2.0	178.00
7" Reel inner diameter	D1	min	62.00
Feed hole diameter	D2	0.5	13.00
Sprocket hole position	E	0.1	1.75
Punch hole position	F	0.1	3.50
Punch hole pitch	P	0.1	4.00
Sprocket hole pitch	P0	0.1	4.00
Embossment center	P1	0.1	2.00
Overall tape thickness	T	0.1	0.23
Tape width	W	0.3	8.00
Reel width	W1	1.0	11.40

Note: Devices are packed in accordance with EIA standard RS-481-A and specifications listed above.