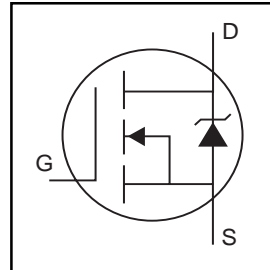


- Advanced Process Technology
- Isolated Package
- High Voltage Isolation = 2.5KVRMS ⑤
- Sink to Lead Creepage Dist. = 4.8mm
- Fully Avalanche Rated

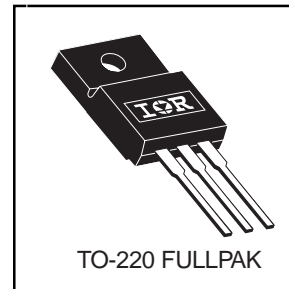
**Description**

Fifth Generation HEXFETs from International Rectifier utilize advanced processing techniques to achieve extremely low on-resistance per silicon area. This benefit, combined with the fast switching speed and ruggedized device design that HEXFET Power MOSFETs are well known for, provides the designer with an extremely efficient and reliable device for use in a wide variety of applications.

The TO-220 Fullpak eliminates the need for additional insulating hardware in commercial-industrial applications. The moulding compound used provides a high isolation capability and a low thermal resistance between the tab and external heatsink. This isolation is equivalent to using a 100 micron mica barrier with standard TO-220 product. The Fullpak is mounted to a heatsink using a single clip or by a single screw fixing.



$V_{DSS} = 100V$
$R_{DS(on)} = 0.025\Omega$
$I_D = 32A$



**Absolute Maximum Ratings**

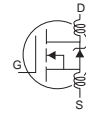
	Parameter	Max.	Units
$I_D @ T_C = 25^\circ C$	Continuous Drain Current, $V_{GS} @ 10V$	32	A
$I_D @ T_C = 100^\circ C$	Continuous Drain Current, $V_{GS} @ 10V$	23	
$I_{DM}$	Pulsed Drain Current ①⑥	180	
$P_D @ T_C = 25^\circ C$	Power Dissipation	63	W
	Linear Derating Factor	0.42	W/°C
$V_{GS}$	Gate-to-Source Voltage	$\pm 20$	V
$E_{AS}$	Single Pulse Avalanche Energy②⑥	530	mJ
$I_{AR}$	Avalanche Current①⑥	28	A
$E_{AR}$	Repetitive Avalanche Energy①	6.3	mJ
dv/dt	Peak Diode Recovery dv/dt ③⑥	5.0	V/ns
$T_J$	Operating Junction and Storage Temperature Range	-55 to + 175	°C
$T_{STG}$			
	Mounting torque, 6-32 or M3 screw	10 lbf•in (1.1N•m)	

**Thermal Resistance**

	Parameter	Typ.	Max.	Units
$R_{\theta JC}$	Junction-to-Case	—	2.4	°C/W
$R_{\theta JA}$	Junction-to-Ambient	—	65	

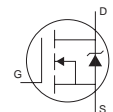
## Electrical Characteristics @ $T_J = 25^\circ\text{C}$ (unless otherwise specified)

	Parameter	Min.	Typ.	Max.	Units	Conditions
$V_{(BR)DSS}$	Drain-to-Source Breakdown Voltage	100	—	—	V	$V_{GS} = 0V, I_D = 250\mu A$
$\Delta V_{(BR)DSS}/\Delta T_J$	Breakdown Voltage Temp. Coefficient	—	0.12	—	V/ $^\circ\text{C}$	Reference to $25^\circ\text{C}, I_D = 1\text{mA}$ Ⓓ
$R_{DS(on)}$	Static Drain-to-Source On-Resistance	—	—	0.025	$\Omega$	$V_{GS} = 10V, I_D = 16A$ Ⓓ
$V_{GS(th)}$	Gate Threshold Voltage	2.0	—	4.0	V	$V_{DS} = V_{GS}, I_D = 250\mu A$
$g_{fs}$	Forward Transconductance	20	—	—	S	$V_{DS} = 25V, I_D = 28A$ Ⓓ
$I_{DSS}$	Drain-to-Source Leakage Current	—	—	25	$\mu A$	$V_{DS} = 100V, V_{GS} = 0V$
		—	—	250		$V_{DS} = 80V, V_{GS} = 0V, T_J = 150^\circ\text{C}$
$I_{GSS}$	Gate-to-Source Forward Leakage	—	—	100	nA	$V_{GS} = 20V$
	Gate-to-Source Reverse Leakage	—	—	-100		$V_{GS} = -20V$
$Q_g$	Total Gate Charge	—	—	190	nC	$I_D = 28A$
$Q_{gs}$	Gate-to-Source Charge	—	—	26		$V_{DS} = 80V$
$Q_{gd}$	Gate-to-Drain ("Miller") Charge	—	—	82		$V_{GS} = 10V$ , See Fig. 6 and 13 ⒹⒺ
$t_{d(on)}$	Turn-On Delay Time	—	14	—	ns	$V_{DD} = 50V$
$t_r$	Rise Time	—	59	—		$I_D = 28A$
$t_{d(off)}$	Turn-Off Delay Time	—	58	—		$R_G = 2.5\Omega$
$t_f$	Fall Time	—	48	—		$R_D = 1.7\Omega$ , See Fig. 10 ⒹⒺ
$L_D$	Internal Drain Inductance	—	4.5	—	nH	Between lead, 6mm (0.25in.) from package and center of die contact
$L_S$	Internal Source Inductance	—	7.5	—		
$C_{iss}$	Input Capacitance	—	3000	—	pF	$V_{GS} = 0V$
$C_{oss}$	Output Capacitance	—	640	—		$V_{DS} = 25V$
$C_{rss}$	Reverse Transfer Capacitance	—	330	—		$f = 1.0\text{MHz}$ , See Fig. 5Ⓓ
C	Drain to Sink Capacitance	—	12	—		$f = 1.0\text{MHz}$



## Source-Drain Ratings and Characteristics

	Parameter	Min.	Typ.	Max.	Units	Conditions
$I_S$	Continuous Source Current (Body Diode)	—	—	32	A	MOSFET symbol showing the integral reverse p-n junction diode.
$I_{SM}$	Pulsed Source Current (Body Diode) ⒹⒺ	—	—	180		
$V_{SD}$	Diode Forward Voltage	—	—	1.3	V	$T_J = 25^\circ\text{C}, I_S = 16A, V_{GS} = 0V$ Ⓓ
$t_{rr}$	Reverse Recovery Time	—	210	320	ns	$T_J = 25^\circ\text{C}, I_F = 28A$
$Q_{rr}$	Reverse Recovery Charge	—	1.7	2.6	$\mu C$	$di/dt = 100A/\mu s$ ⒹⒺ
$t_{on}$	Forward Turn-On Time	Intrinsic turn-on time is negligible (turn-on is dominated by $L_S+L_D$ )				



### Notes:

- Ⓓ Repetitive rating; pulse width limited by max. junction temperature. ( See fig. 11 )
- Ⓔ Pulse width  $\leq 300\mu s$ ; duty cycle  $\leq 2\%$ .
- Ⓒ  $V_{DD} = 25V$ , starting  $T_J = 25^\circ\text{C}$ ,  $L = 1.4\text{mH}$ ,  $R_G = 25\Omega$ ,  $I_{AS} = 28A$ . (See Figure 11)
- Ⓓ  $t = 60s, f = 60\text{Hz}$
- Ⓕ  $I_{SD} \leq 28A, di/dt \leq 460A/\mu s, V_{DD} \leq V_{(BR)DSS}, T_J \leq 175^\circ\text{C}$
- Ⓖ Uses IRF3710 data and test conditions

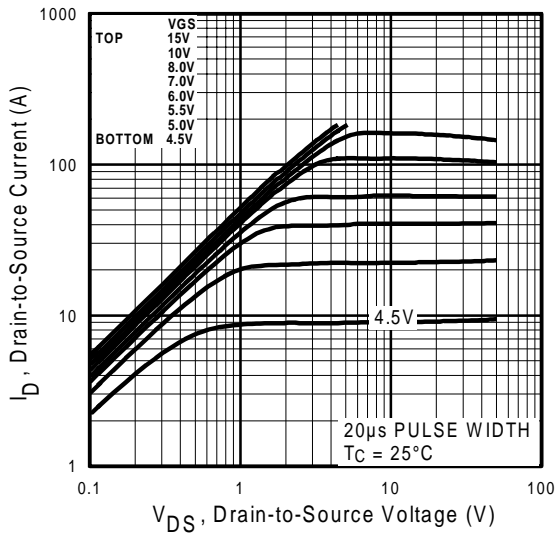


Fig 1. Typical Output Characteristics

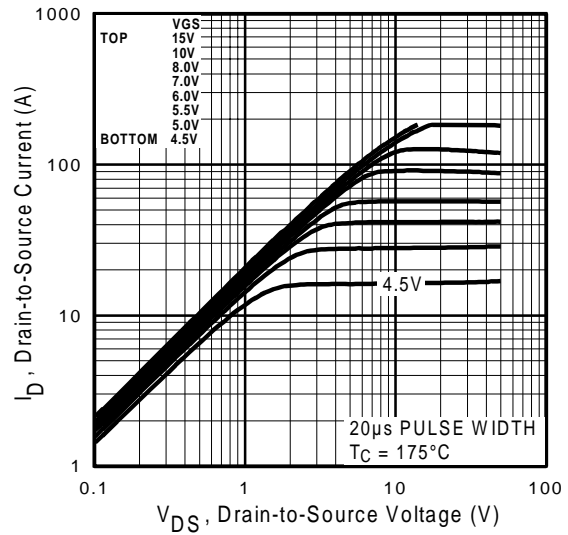


Fig 2. Typical Output Characteristics

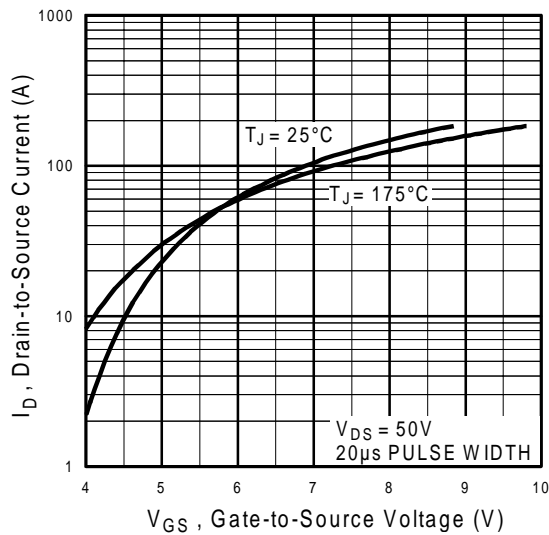


Fig 3. Typical Transfer Characteristics

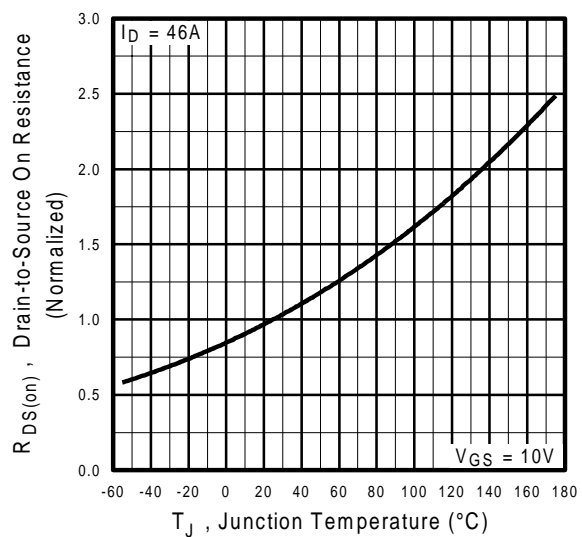
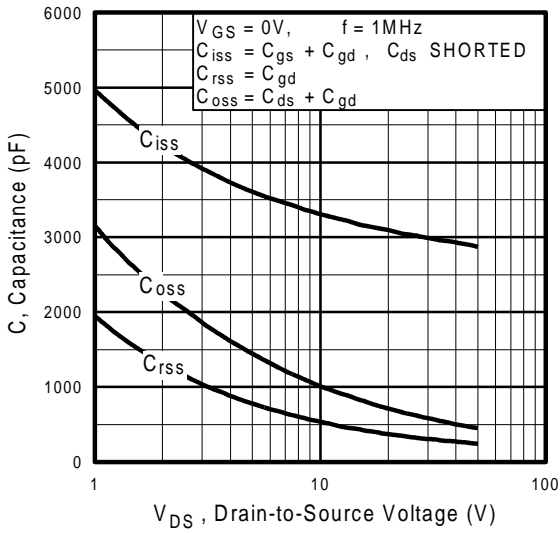
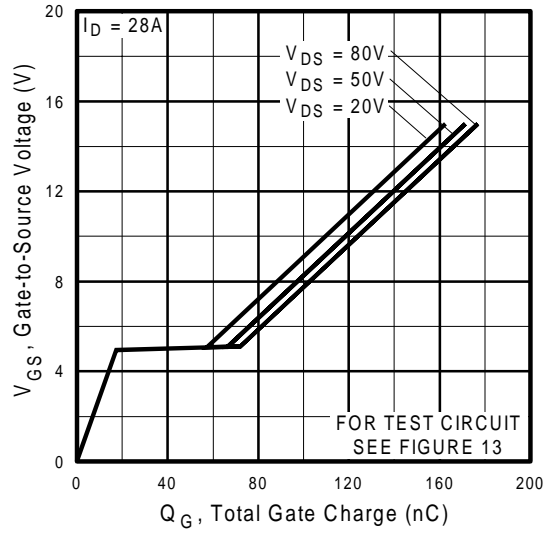


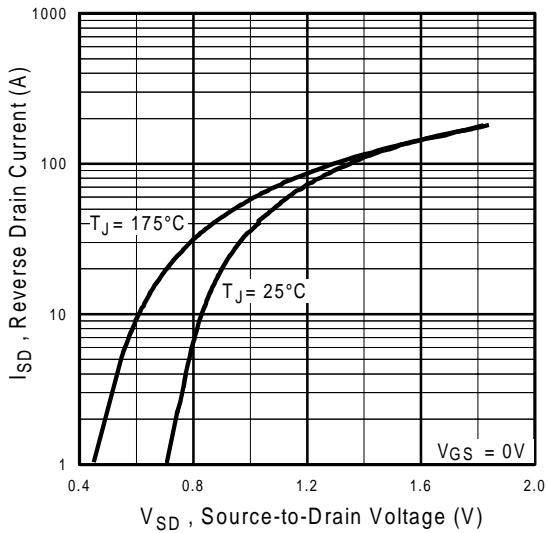
Fig 4. Normalized On-Resistance Vs. Temperature



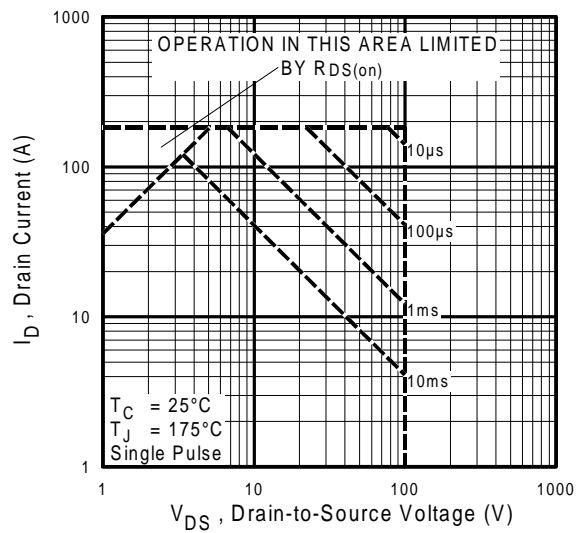
**Fig 5.** Typical Capacitance Vs. Drain-to-Source Voltage



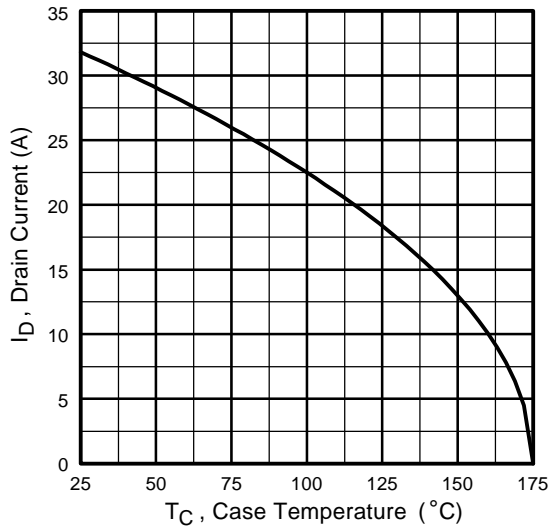
**Fig 6.** Typical Gate Charge Vs. Gate-to-Source Voltage



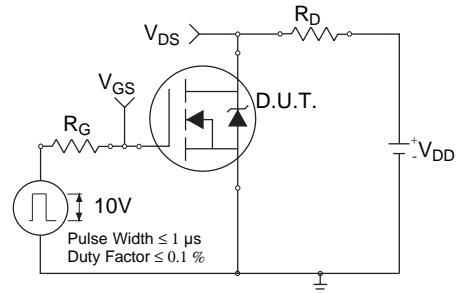
**Fig 7.** Typical Source-Drain Diode Forward Voltage



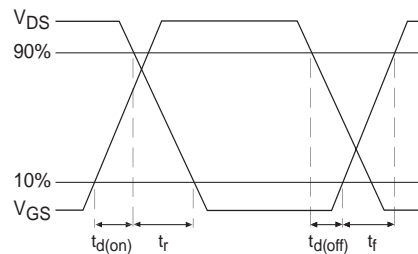
**Fig 8.** Maximum Safe Operating Area



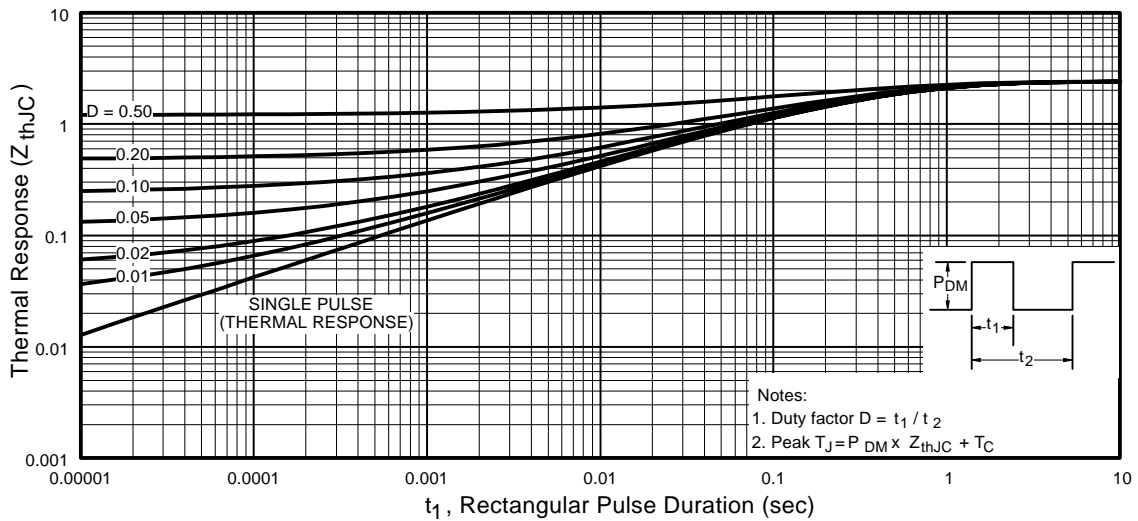
**Fig 9.** Maximum Drain Current Vs. Case Temperature



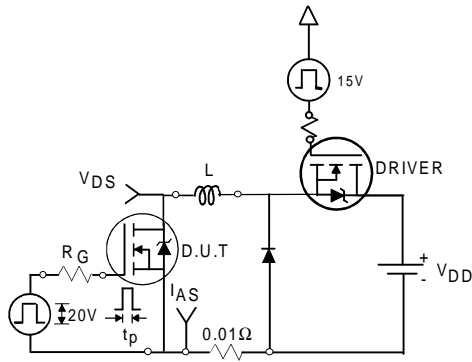
**Fig 10a.** Switching Time Test Circuit



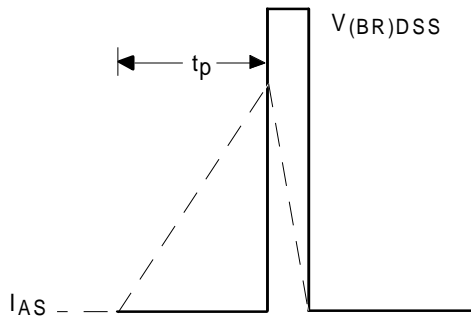
**Fig 10b.** Switching Time Waveforms



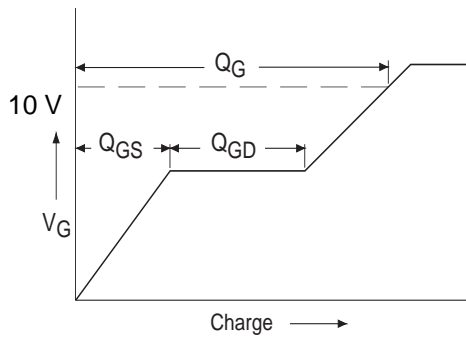
**Fig 11.** Maximum Effective Transient Thermal Impedance, Junction-to-Case



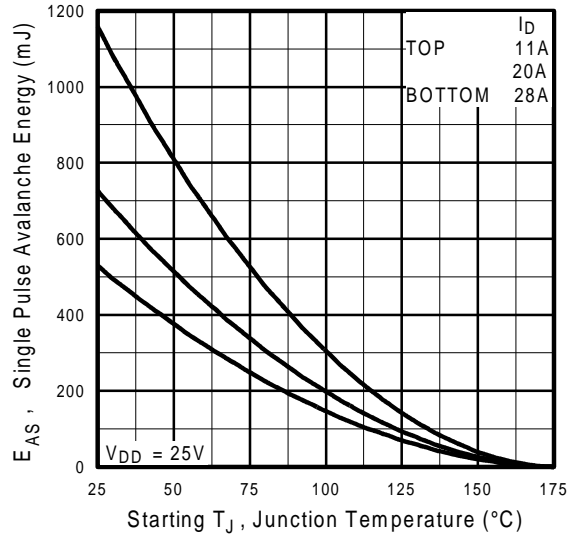
**Fig 12a.** Unclamped Inductive Test Circuit



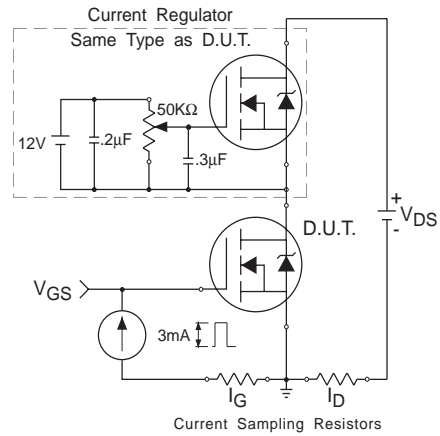
**Fig 12b.** Unclamped Inductive Waveforms



**Fig 13a.** Basic Gate Charge Waveform

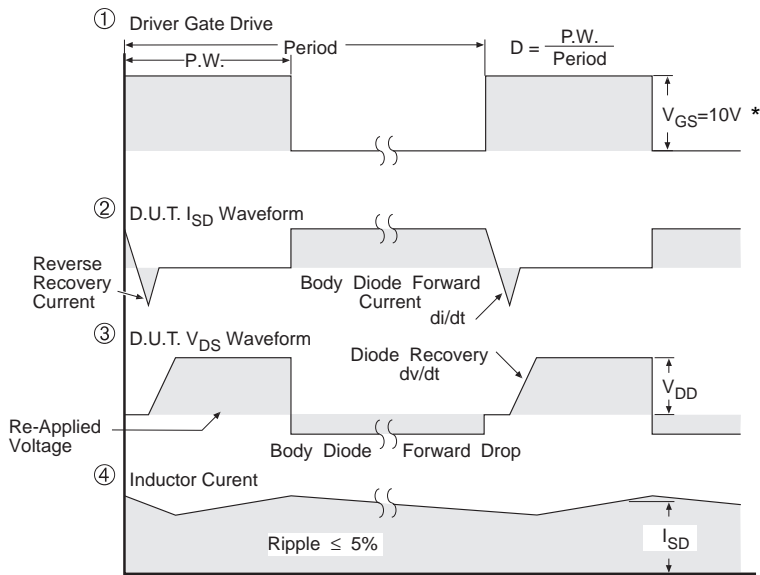
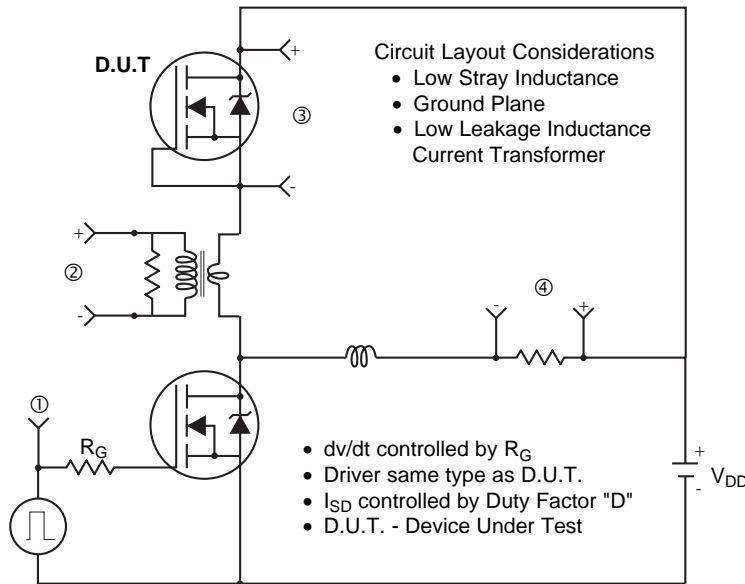


**Fig 12c.** Maximum Avalanche Energy Vs. Drain Current



**Fig 13b.** Gate Charge Test Circuit

**Peak Diode Recovery dv/dt Test Circuit**



\*  $V_{GS} = 5V$  for Logic Level Devices

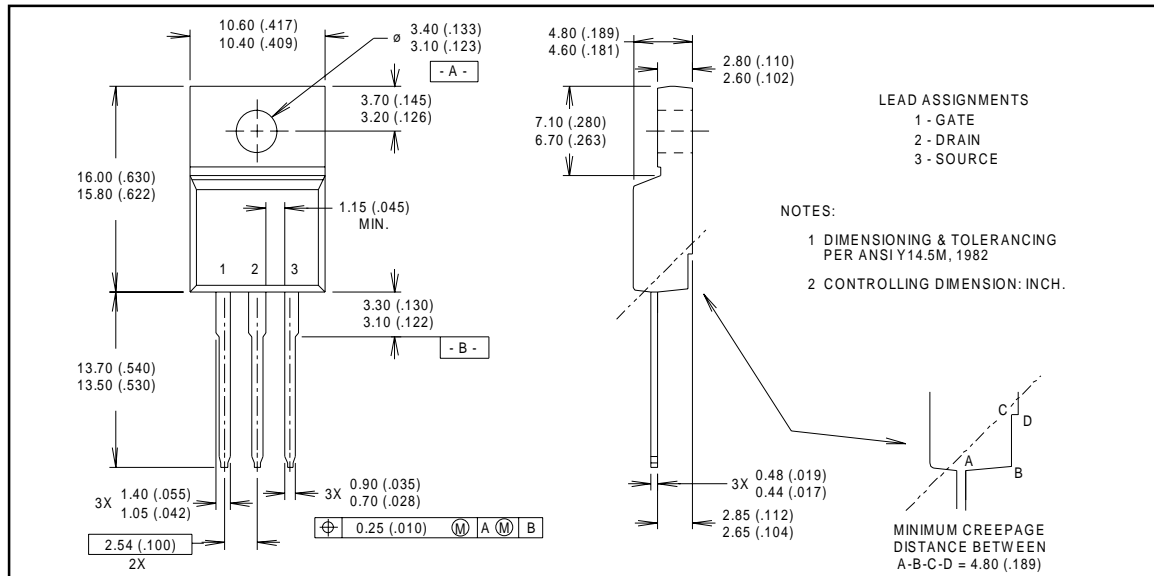
**Fig 14. For N-Channel HEXFETS**

# IRFI3710

International  
**IR** Rectifier

## Package Outline TO-220 Fullpak Outline

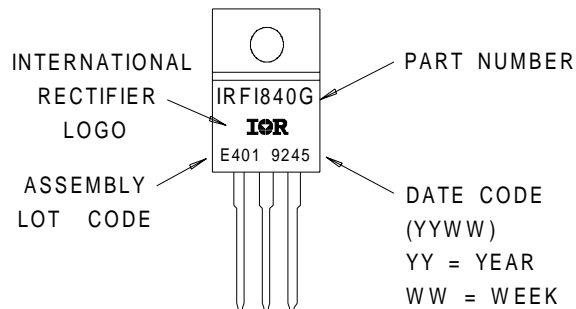
Dimensions are shown in millimeters (inches)



## Part Marking Information

### TO-220 Fullpak

EXAMPLE : THIS IS AN IRFI840G  
WITH ASSEMBLY  
LOT CODE E401



International  
**IR** Rectifier

**WORLD HEADQUARTERS:** 233 Kansas St., El Segundo, California 90245, Tel: (310) 322 3331

**EUROPEAN HEADQUARTERS:** Hurst Green, Oxted, Surrey RH8 9BB, UK Tel: ++ 44 1883 732020

**IR CANADA:** 7321 Victoria Park Ave., Suite 201, Markham, Ontario L3R 2Z8, Tel: (905) 475 1897

**IR GERMANY:** Saalburgstrasse 157, 61350 Bad Homburg Tel: ++ 49 6172 96590

**IR ITALY:** Via Liguria 49, 10071 Borgaro, Torino Tel: ++ 39 11 451 0111

**IR FAR EAST:** K&H Bldg., 2F, 30-4 Nishi-Ikebukuro 3-Chome, Toshima-Ku, Tokyo Japan 171 Tel: 81 3 3983 0086

**IR SOUTHEAST ASIA:** 315 Outram Road, #10-02 Tan Boon Liat Building, Singapore 0316 Tel: 65 221 8371

<http://www.irf.com/>

Data and specifications subject to change without notice.

3/98