

STT60GKxxB

Thyristor-Thyristor Modules

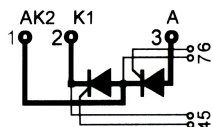

Type	V_{RSM} V_{DSM} V	V_{RRM} V_{DRM} V
STT60GK08B	900	800
STT60GK12B	1300	1200
STT60GK14B	1500	1400
STT60GK16B	1700	1600
STT60GK18B	1900	1800

Tolerance: $\pm 0.5\text{mm}$
Dimensions in mm (1mm=0.0394")

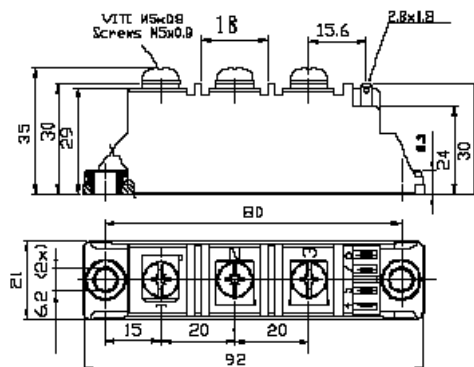

Symbol	Test Conditions	Maximum Ratings	Unit
I_{TRMS}, I_{FRMS} I_{TAVM}, I_{FAVM}	$T_V = T_{VJM}$ $T_C = 85^\circ\text{C}; 180^\circ$ sine	94 60	A
I_{TSM}, I_{FSM}	$T_V = 45^\circ\text{C}$ $V_R = 0$ $t = 10\text{ms}$ (50Hz), sine $t = 8.3\text{ms}$ (60Hz), sine	1500 1600	A
	$T_V = T_{VJM}$ $V_R = 0$ $t = 10\text{ms}$ (50Hz), sine $t = 8.3\text{ms}$ (60Hz), sine	1350 1450	
$i^2 dt$	$T_V = 45^\circ\text{C}$ $V_R = 0$ $t = 10\text{ms}$ (50Hz), sine $t = 8.3\text{ms}$ (60Hz), sine	11200 10750	A ² s
	$T_V = T_{VJM}$ $V_R = 0$ $t = 10\text{ms}$ (50Hz), sine $t = 8.3\text{ms}$ (60Hz), sine	9100 8830	
$(di/dt)_{cr}$	$T_V = T_{VJM}$ $f = 50\text{Hz}, t_p = 200\mu\text{s}$ $V_D = 2/3 V_{DRM}$ $I_G = 0.45\text{A}$ $di/dt = 0.45\text{A}/\mu\text{s}$	repetitive, $I_T = 150\text{A}$ 150	A/ μs
		non repetitive, $I_T = I_{TAVM}$ 500	
$(dv/dt)_{cr}$	$T_V = T_{VJM};$ $R_{GK} = \infty;$ method 1 (linear voltage rise)	$V_{DR} = 2/3 V_{DRM}$ 1000	V/ μs
P_{GM}	$T_V = T_{VJM}$ $I_T = I_{TAVM}$	$t_p = 30\mu\text{s}$ 10	W
		$t_p = 300\mu\text{s}$ 5	
P_{GAV}		0.5	W
V_{RGM}		10	V
T_V T_{VJM} T_{stg}		-40...+125	$^\circ\text{C}$
		125	
		-40...+125	
V_{ISOL}	50/60Hz, RMS $I_{ISOL} \leq 1\text{mA}$	$t = 1\text{min}$ 3000	V~
		$t = 1\text{s}$ 3600	
M_d	Mounting torque (M5)	2.5-4.0/22-35	Nm/lb.in.
	Terminal connection torque (M5)	2.5-4.0/22-35	
Weight	Typ.	110	g

STT60GKxxB

Thyristor-Thyristor Modules

Symbol	Test Conditions	Characteristic Values	Unit
I_{RRM}, I_{DRM}	$T_{VJ}=T_{VJM}; V_R=V_{RRM}; V_D=V_{DRM}$	5	mA
V_{TM}	$I_{TM}=180A; T_{VJ}=25^{\circ}C$	1.65	V
V_{TO}	For power-loss calculations only ($T_{VJ}=125^{\circ}C$)	0.85	V
r_T		3.7	mΩ
V_{GT}	$V_D=6V; T_{VJ}=25^{\circ}C$ $T_{VJ}=-40^{\circ}C$	1.5 max 1.6 max	V
I_{GT}	$V_D=6V; T_{VJ}=25^{\circ}C$ $T_{VJ}=-40^{\circ}C$	100 200	mA
V_{GD}	$T_{VJ}=T_{VJM}; V_D=2/3V_{DRM}$	0.2	V
I_{GD}		10	mA
I_L	$T_{VJ}=25^{\circ}C; t_p=10\mu s; V_D=6V$ $I_G=0.45A; di_G/dt=0.45A/\mu s$	450	mA
I_H	$T_{VJ}=25^{\circ}C; V_D=6V; R_{GK}=\infty$	200	mA
t_{gd}	$T_{VJ}=25^{\circ}C; V_D=1/2V_{DRM}$ $I_G=0.45A; di_G/dt=0.45A/\mu s$	2	us
t_q	$T_{VJ}=T_{VJM}; I_T=150A; t_p=200\mu s; -di/dt=10A/\mu s$ $V_R=100V; dv/dt=20V/\mu s; V_D=2/3V_{DRM}$	150	us
Q_s	$T_{VJ}=T_{VJM}; I_T, I_F=50A; -di/dt=3A/\mu s$	100	uC
I_{RM}		24	A
R_{thJC}	per thyristor/diode; DC current per module	0.45 0.225	K/W
R_{thJK}	per thyristor/diode; DC current per module	0.65 0.325	K/W
d_s	Creeping distance on surface	12.7	mm
d_A	Strike distance through air	9.6	mm
a	Maximum allowable acceleration	50	m/s ²

FEATURES

- * International standard package
- * Copper base plate
- * Glass passivated chips
- * Isolation voltage 3600 V~
- * UL file NO.310749
- * RoHs compliant

APPLICATIONS

- * DC motor control
- * Softstart AC motor controller
- * Light, heat and temperature control

ADVANTAGES

- * Space and weight savings
- * Simple mounting with two screws
- * Improved temperature and power cycling
- * Reduced protection circuits

STT60GKxxB

Thyristor-Thyristor Modules

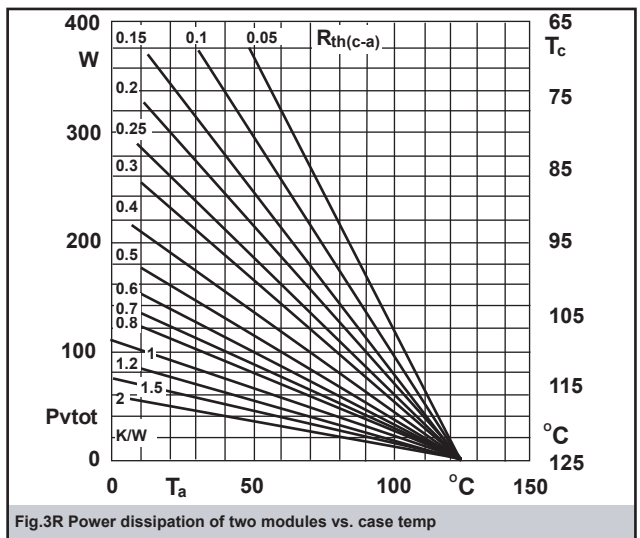
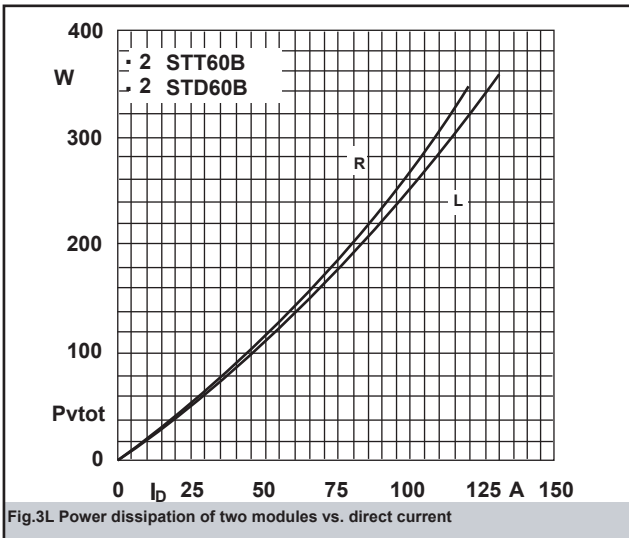
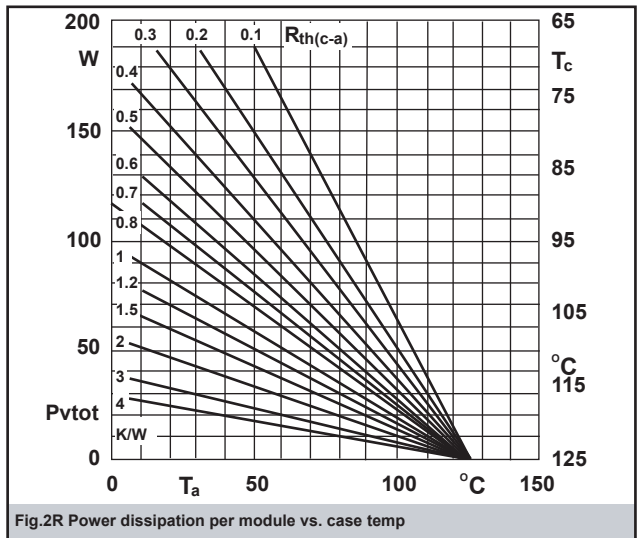
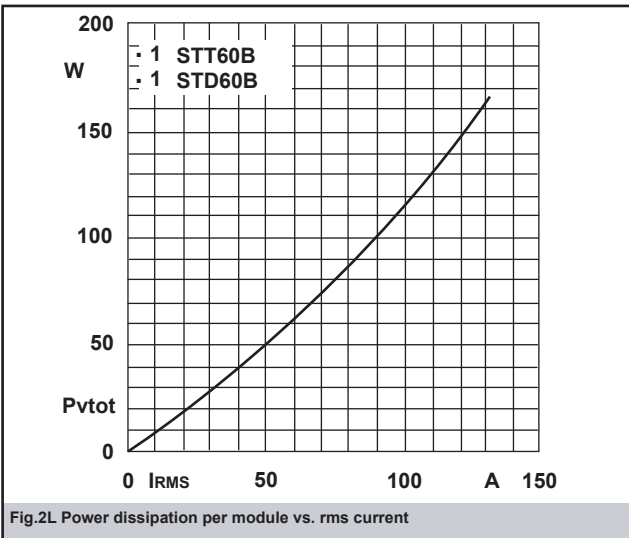
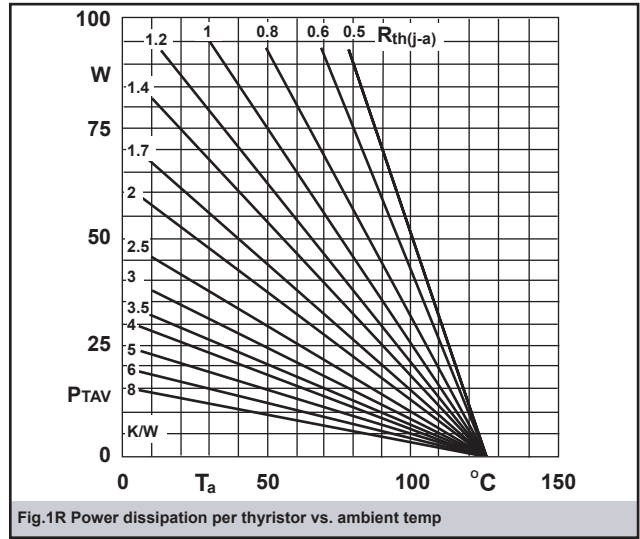
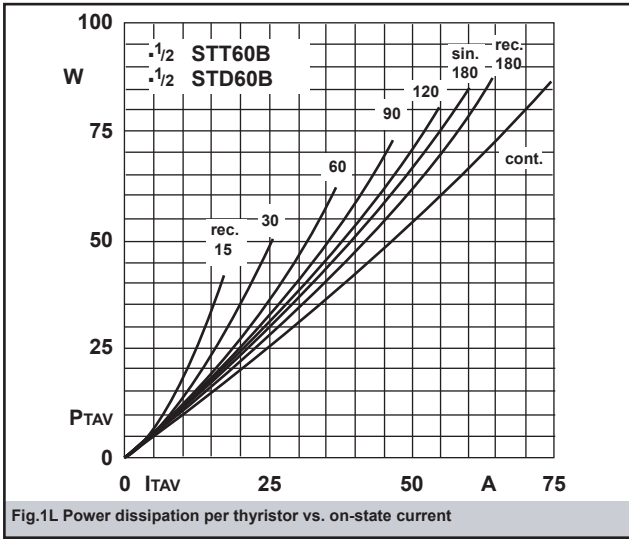

STT60KxxB

Thyristor-Thyristor Modules

