

Silicon PNP Power Transistors

2SB1455

DESCRIPTION

- With TO-220F package
- Complement to type 2SD2203
- Low collector saturation voltage:
- Large current capacity

APPLICATIONS

- High current power switching applications

PINNING

PIN	DESCRIPTION
1	Emitter
2	Collector
3	Base

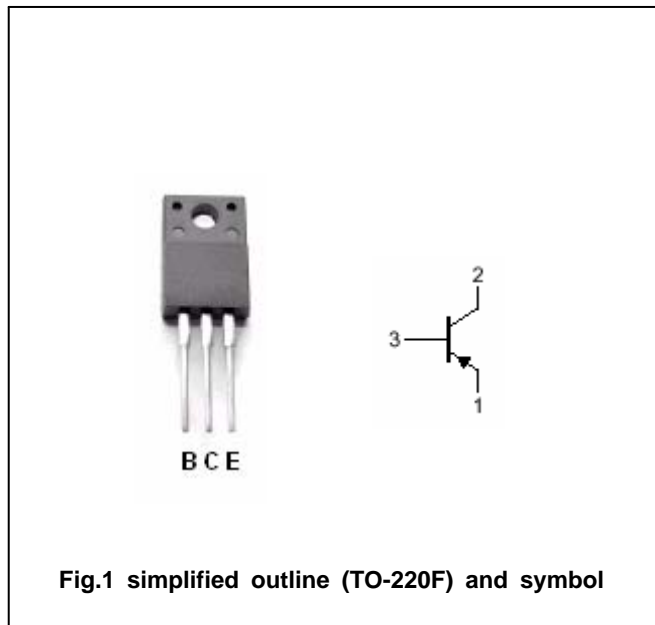

Absolute maximum ratings (Ta=25)

SYMBOL	PARAMETER	CONDITIONS	VALUE	UNIT
V_{CBO}	Collector-base voltage	Open emitter	-90	V
V_{CEO}	Collector-emitter voltage	Open base	-80	V
V_{EBO}	Emitter-base voltage	Open collector	-6	V
I_C	Collector current		-7	A
I_{CM}	Collector current-peak		-12	A
P_C	Collector dissipation	$T_a=25$	2.0	W
		$T_C=25$	30	
T_j	Junction temperature		150	
T_{stg}	Storage temperature		-55~150	

Silicon PNP Power Transistors

2SB1455

CHARACTERISTICS

T_j=25 unless otherwise specified

SYMBOL	PARAMETER	CONDITIONS	MIN	TYP.	MAX	UNIT
V _{(BR)CEO}	Collector-emitter breakdown voltage	I _C =-1mA ;R _{BE} =	-80			V
V _{(BR)CBO}	Collector-base breakdown voltage	I _C =-1mA ;I _E =0	-90			V
V _{(BR)EBO}	Emitter-base breakdown voltage	I _E =-1mA ;I _C =0	-6			V
V _{CEsat}	Collector-emitter saturation voltage	I _C =-4A ;I _B =-0.4A			-0.5	V
I _{CBO}	Collector cut-off current	V _{CB} =-80V ; I _E =0			-0.1	mA
I _{EBO}	Emitter cut-off current	V _{EB} =-4V ; I _C =0			-0.1	mA
h _{FE-1}	DC current gain	I _C =-1A ; V _{CE} =-2V	70		280	
h _{FE-2}	DC current gain	I _C =-4A ; V _{CE} =-2V	30			
f _T	Transition frequency	I _C =-1A ; V _{CE} =-5V		20		MHz

Switching times

t _{on}	Turn-on time	I _C =-2.0A I _{B1} =-I _{B2} =-0.2A V _{CC} =-50V ,R _L =25		0.2		μs
t _s	Storage time			0.7		μs
t _f	Fall time			0.2		μs

◆ h_{FE-1} Classifications

Q	R	S
70-140	100-200	140-280

Silicon PNP Power Transistors

2SB1455

PACKAGE OUTLINE

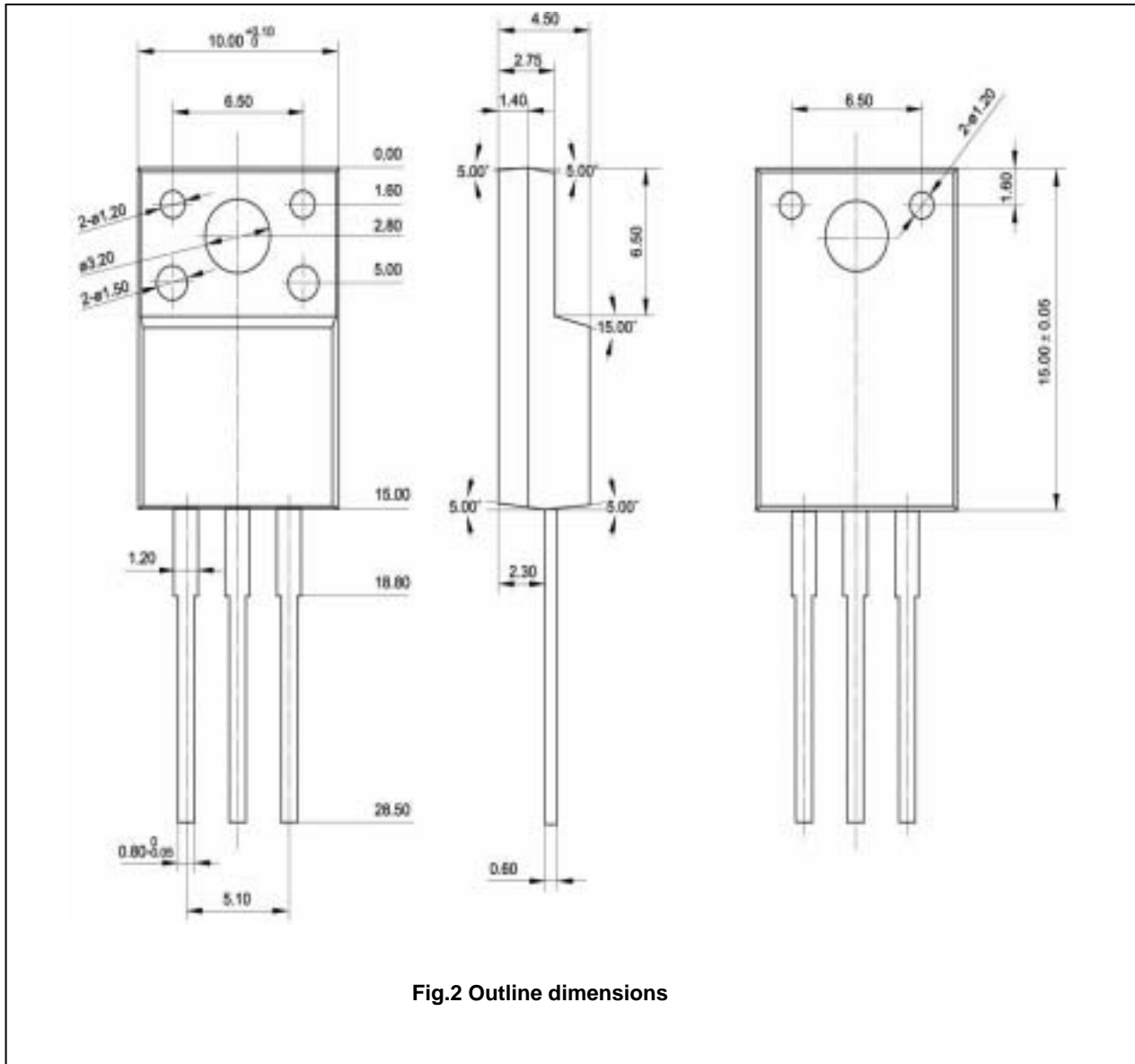

Fig.2 Outline dimensions

Silicon PNP Power Transistors

2SB1455

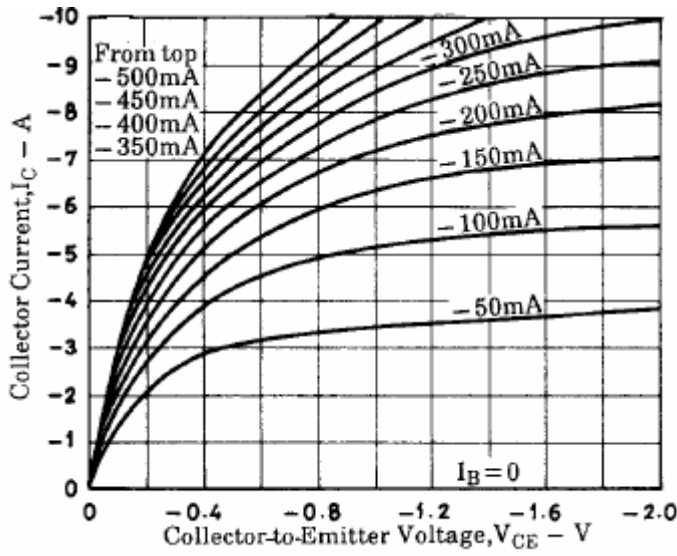

Fig.3 Static Characteristic

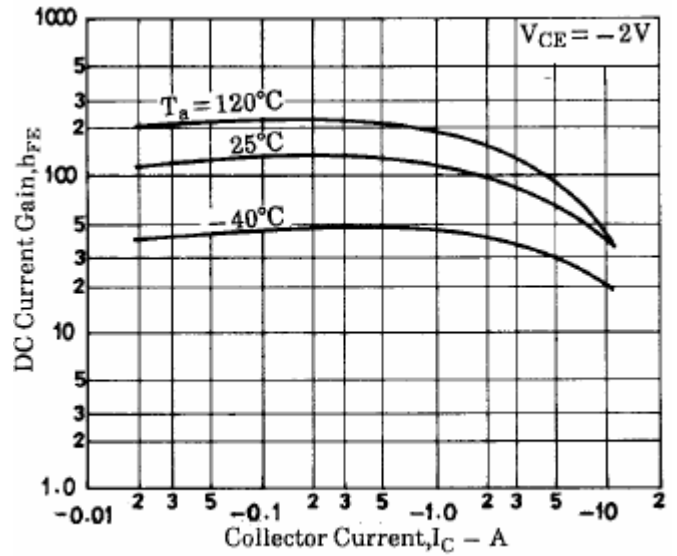

Fig.4 DC current Gain

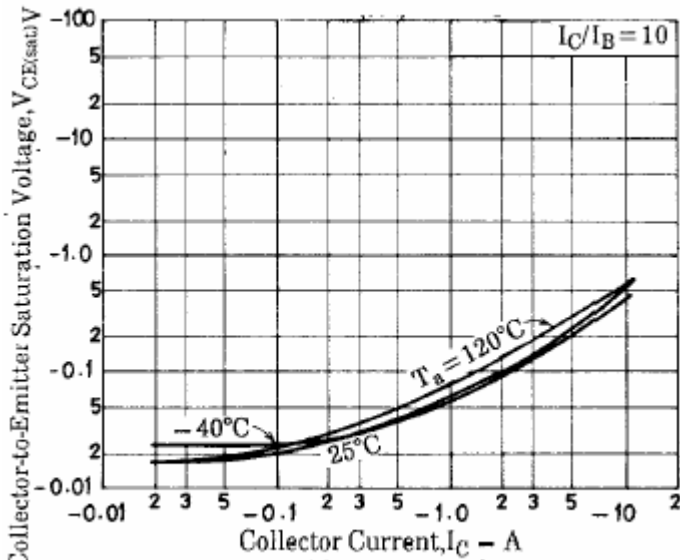

Fig.5 Collector-Emitter Saturation Voltage

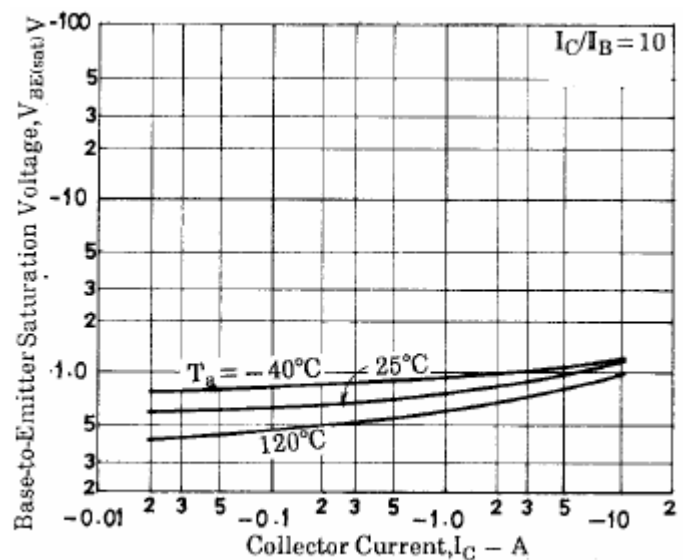

Fig.6 Base-Emitter Saturation Voltage

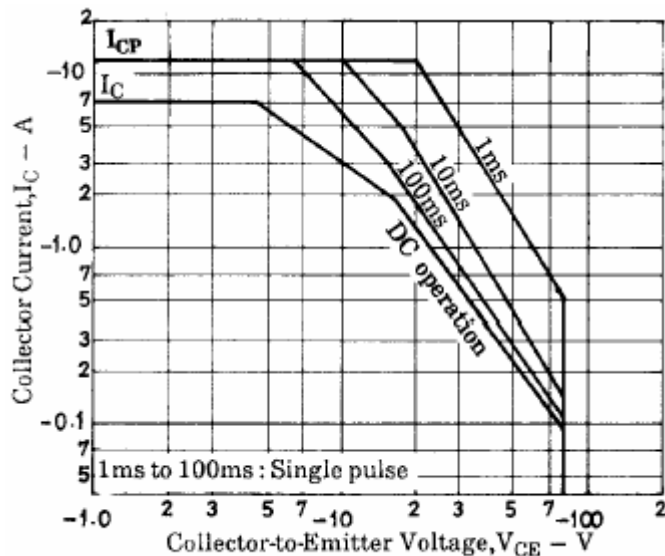

Fig.7 Safe Operating Area