

### GENERAL DESCRIPTION

This Trench MOSFET has better characteristics, such as fast switching time, low on resistance, low gate charge and excellent avalanche characteristics. It is mainly suitable for portable equipment and DC-DC Converter Applications.

### FEATURES

- $V_{DSS}=30V$ ,  $I_D=6A$ .
- Drain-Source ON Resistance.  
 $R_{DS(ON)}=28m\ \Omega$  (Max.) @  $V_{GS}=10V$   
 $R_{DS(ON)}=42m\ \Omega$  (Max.) @  $V_{GS}=4.5V$
- Super High Dense Cell Design
- High Power and Current Handling Capability

### MAXIMUM RATING (Ta=25 °C Unless otherwise noted)

CHARACTERISTIC		SYMBOL	RATING	UNIT
Drain Source Voltage		$V_{DSS}$	30	V
Gate Source Voltage		$V_{GSS}$	+20	V
Drain Current	DC	$I_D^*$	6	A
	Pulsed	$I_{DP}$	30	A
Drain Source Diode Forward Current		$I_S$	1.7	A
Drain Power Dissipation	25 °C	$P_D^*$	2	W
Maximum Junction Temperature		$T_j$	150	°C
Storage Temperature Range		$T_{stg}$	-50~150	°C
Thermal Resistance, Junction to Ambient		$R_{thJA}^*$	62.5	°C/W

Note> \*Surface Mounted on FR4 Board,  $t \leq 10sec$ .

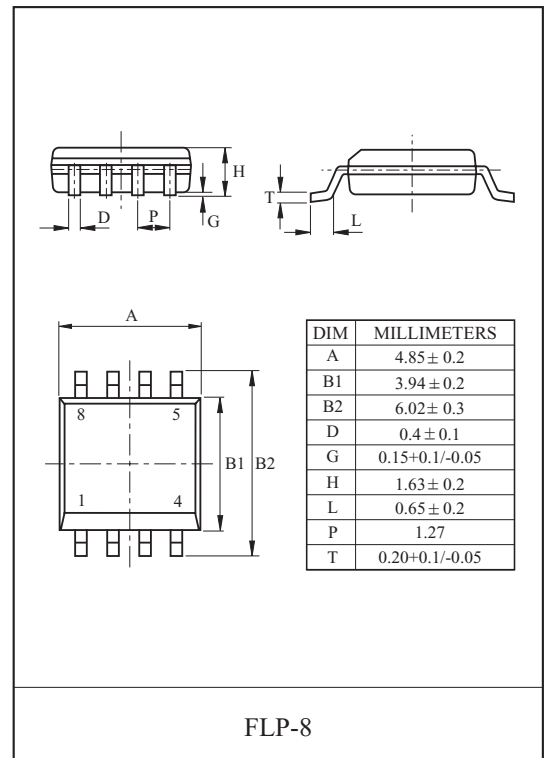

### Marking

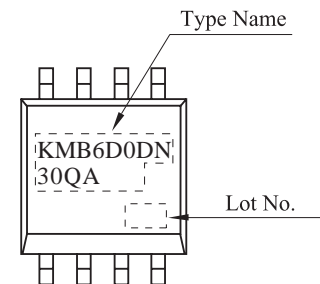

### PIN CONNECTION (TOP VIEW)

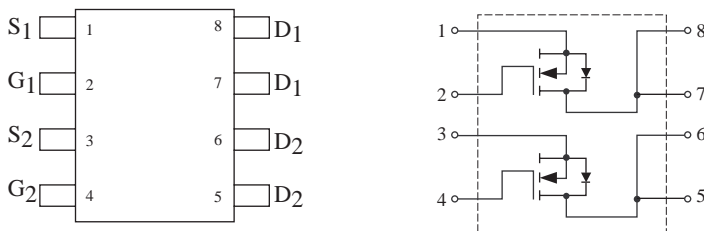

# KMB6D0DN30QA

## ELECTRICAL CHARACTERISTICS (Ta=25 °C) UNLESS OTHERWISE NOTED

CHARACTERISTIC	SYMBOL	TEST CONDITION	MIN.	TYP.	MAX.	UNIT
<b>Static</b>						
Drain-Source Breakdown Voltage	$BV_{DSS}$	$I_D=250\mu A, V_{GS}=0V$	30	-	-	V
Drain Cut-off Current	$I_{DSS}$	$V_{DS}=24V, V_{GS}=0V$	-	-	1	$\mu A$
Gate Leakage Current	$I_{GSS}$	$V_{GS}=\pm 20V, V_{DS}=0V$	-	-	$\pm 100$	nA
Gate Threshold Voltage	$V_{th}$	$V_{DS}=V_{GS}, I_D=250\mu A$	1.0	1.7	2.5	V
Drain-Source ON Resistance	$R_{DS(ON)}^*$	$V_{GS}=10V, I_D=6A$	-	24	28	m $\Omega$
		$V_{GS}=4.5V, I_D=5A$	-	35	42	
On-State Drain Current	$I_{D(ON)}^*$	$V_{DS}=5V, V_{GS}=10V$	20	-	-	A
Forward Transconductance	$g_{fs}^*$	$V_{DS}=5V, I_D=6A$	-	20	-	S
<b>Dynamic</b>						
Input Capacitance	$C_{iss}$	$V_{DS}=15V, f=1MHz, V_{GS}=0V$	-	576	-	pF
Output Capacitance	$C_{oss}$		-	111	-	
Reverse Transfer Capacitance	$C_{rss}$		-	75	-	
Total Gate Charge	$Q_g^*$	$V_{DS}=15V, V_{GS}=10V, I_D=2A$	-	12.5	-	nC
Gate-Source Charge	$Q_{gs}^*$		-	2.0	-	
Gate-Drain Charge	$Q_{gd}^*$		-	2.8	-	
Turn-On Delay Time	$t_{d(on)}^*$	$V_{DD}=15V, V_{GS}=10V$ $I_D=1A, R_G=6 \Omega$	-	7.8	-	ns
Turn-On Rise Time	$t_r^*$		-	11.6	-	
Turn-Off Delay Time	$t_{d(off)}^*$		-	15.3	-	
Turn-Off Fall Time	$t_f^*$		-	16	-	
<b>Source-Drain Diode Ratings</b>						
Source-Drain Forward Voltage	$V_{SDF}^*$	$I_{DR}=1.7A, V_{GS}=0V$	-	0.75	1.2	V
Note> * Pulse Test : Pulse width $\leq 300\mu s$ , Duty cycle $\leq 2\%$						

# KMB6D0DN30QA

Fig1.  $I_D - V_{DS}$

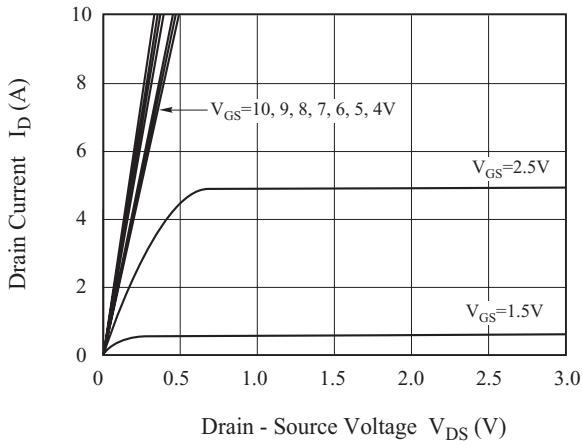

Fig2.  $R_{DS(on)} - I_D$

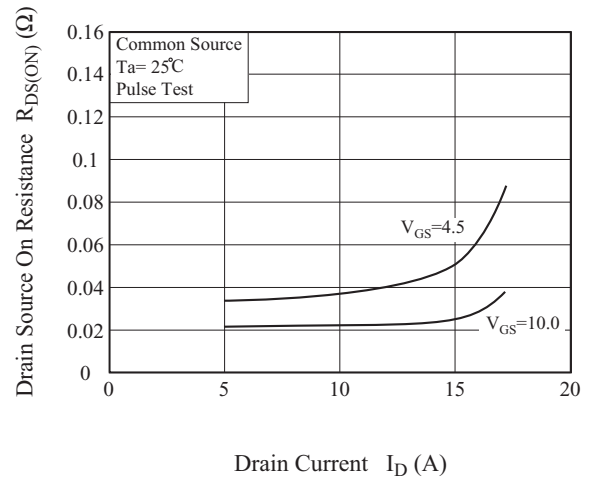

Fig3.  $I_D - V_{GS}$

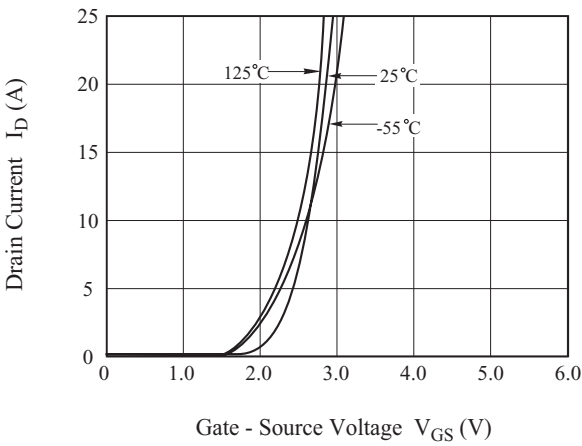

Fig4.  $R_{DS(on)} - T_j$

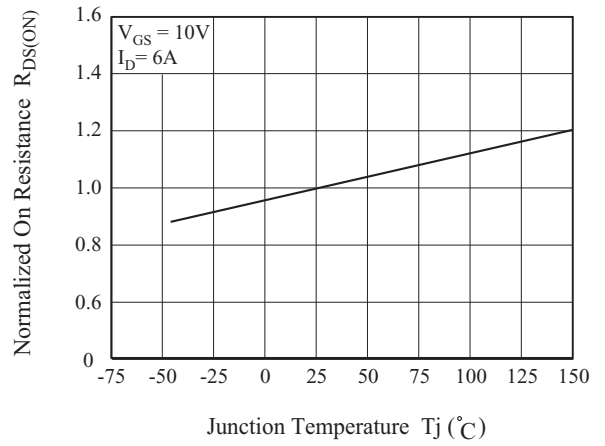

Fig5.  $V_{th} - T_j$

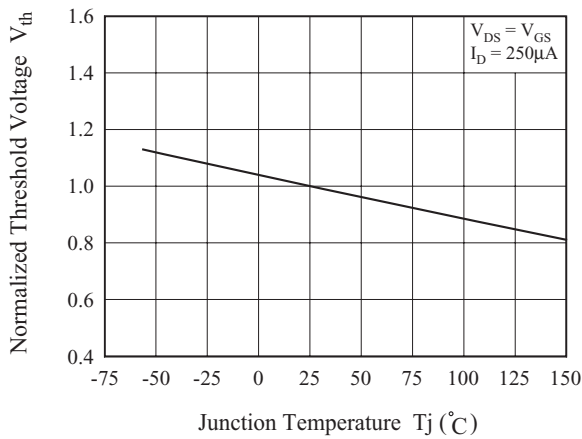
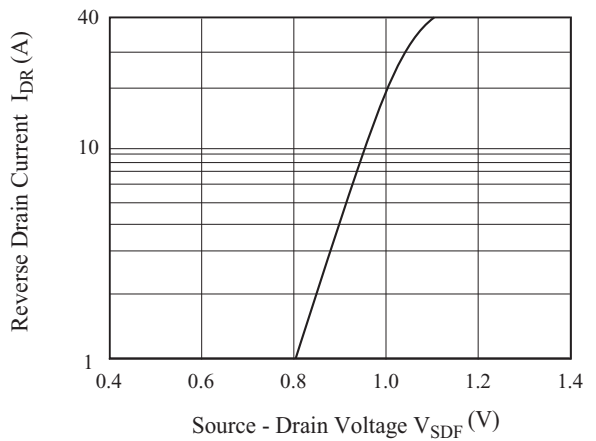

Fig6.  $I_S - V_{SDF}$



# KMB6D0DN30QA

Fig7. C - V<sub>DS</sub>

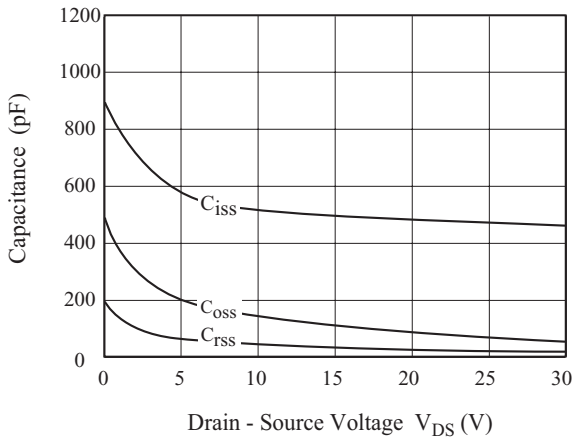

Fig8. Q<sub>g</sub> - V<sub>GS</sub>

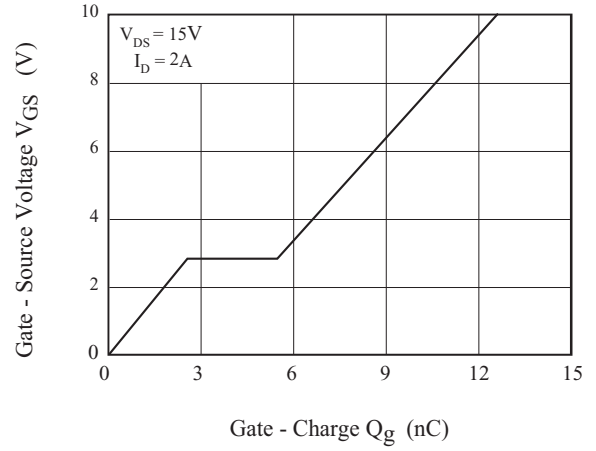

Fig9. Safe Operation Area

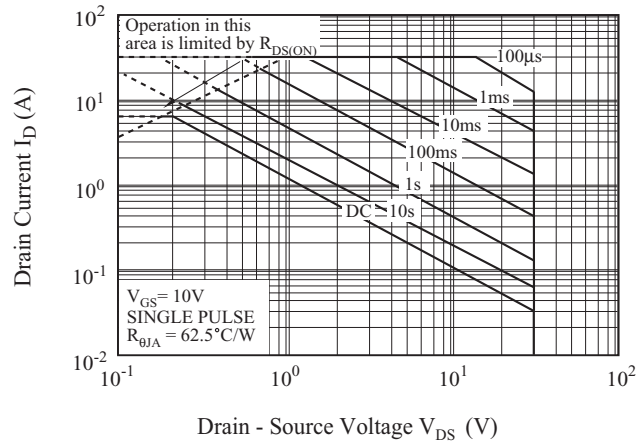
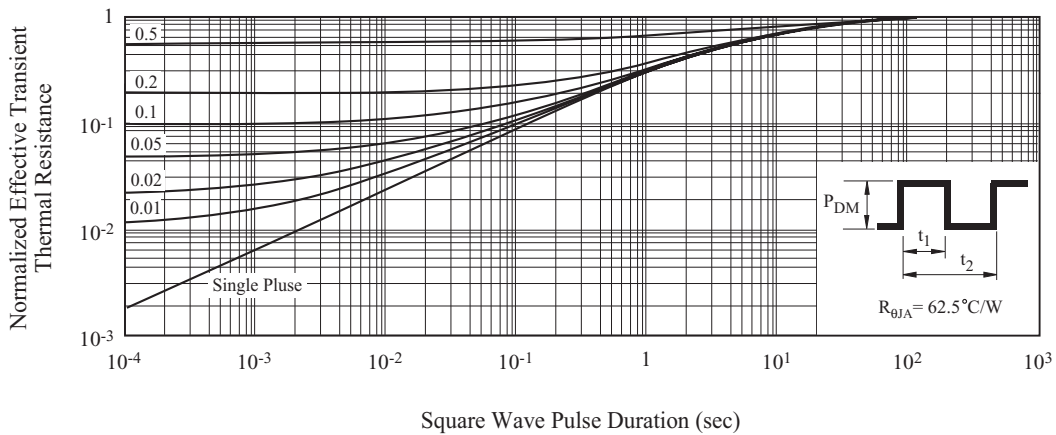

Fig10. Transient Thermal Response Curve



# KMB6D0DN30QA

Fig11. Gate Charge

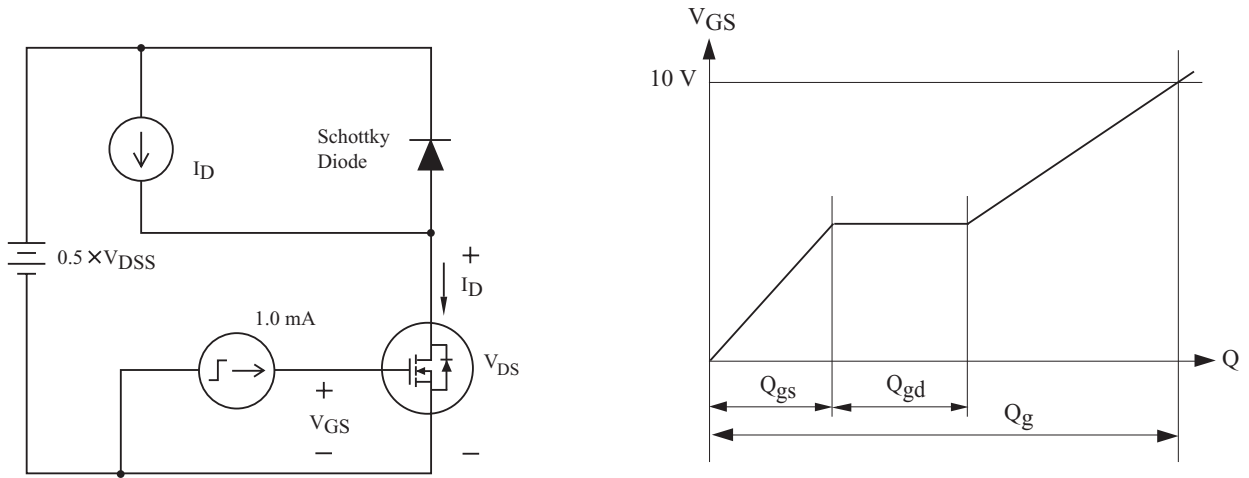

Fig12. Resistive Load Switching

