

VH CONNECTOR

Disconnectable Crimp style connectors

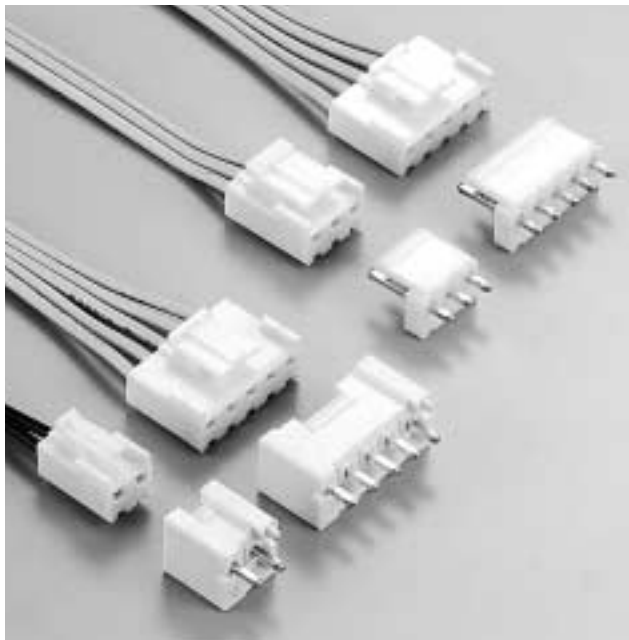

This small, field-proven connector for printed circuit boards is reliable and has a large current carrying capacity. It can be used with a wide variety of signal, power supply, and output circuits that appear in consumer electronic products.

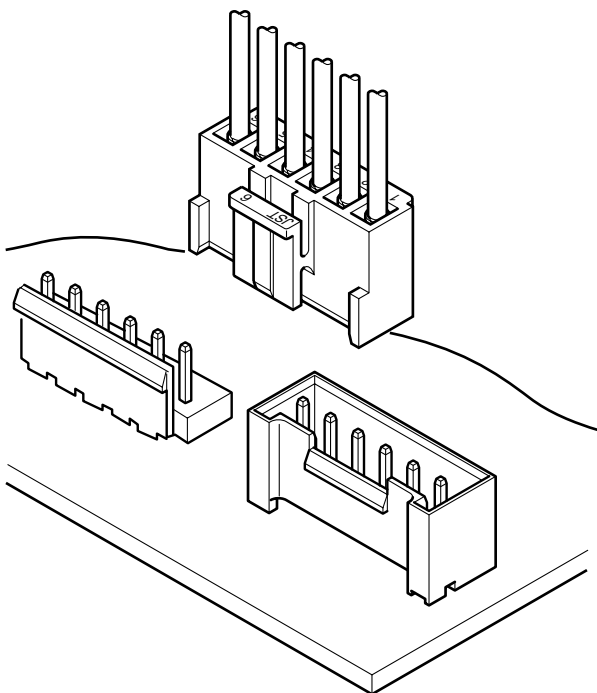

Features

• **Proven box contact**

This connector was developed with the same box-shaped contact design used successfully in the NH connectors. The reliable VH connector can be used in a wide variety of applications, from low-voltage, low-current signal circuits to power supply circuits having a relatively large capacity.

• **Compact connector with a large capacity**

Even though this connector has a large current carrying capacity (10A), it is compact, with a mounting height of 16.5mm (.650").

• **Secure contact and mounting**

The housing has a lock mechanism which prevents the connector from coming loose due to vibration. The mechanism also prevents misinsertion (misalignment or reverse insertion).

Specifications

- Current rating: 10A AC, DC (AWG#16)
- Voltage rating: 250V AC, DC
- Temperature range: -25°C to +85°C
(including temperature rise in applying electrical current)
- Contact resistance: Initial value/10m Ω max.
After environmental testing/20m Ω max.
- Insulation resistance: 1,000M Ω min.
- Withstanding voltage: 1,500V AC/minute
- Applicable wire: AWG #22 to #16
- Applicable PC board thickness: 1.6mm(.063")

Note:

Do not branch in parallel current which exceeds the rated current. If branched in parallel, current imbalance or other problems may develop. If it is absolutely necessary to branch such a large current in parallel, be sure to use contacts made of phosphor bronze. Design the circuits without causing imbalance and provide an extra margin for each circuit.

*Contact JST for details.

Standards

- Recognized E60389
- 1 Certified LR20812
- 2 R75122

VH CONNECTOR

Contact

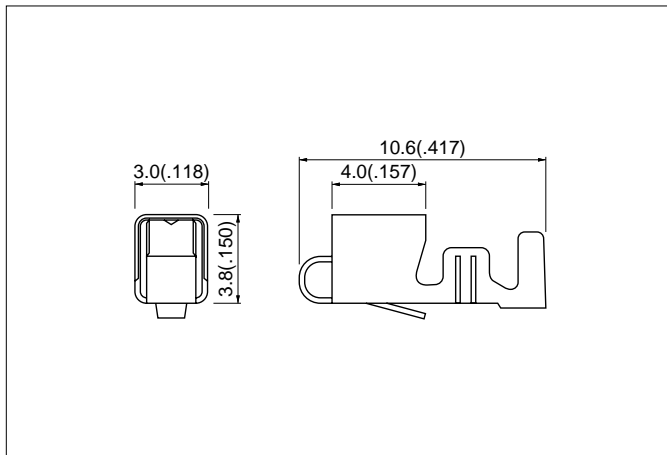

Model No.	Applicable wire			Q'ty / reel
	mm ²	AWG #	Insulation O.D. mm(in.)	
SVH-21T-P1.1	0.33 to 0.83	22 to 18	1.7 to 3.0 (.067 to .118)	4,500
SVH-41T-P1.1	0.5 to 1.25	20 to 16	1.7 to 3.0 (.067 to .118)	3,500

Material and Finish

Phosphor bronze, tin-plated

Note: When using retainer mountable type housing, applicable wire's insulation O. D. shall be 1.7 to 2.2mm(.067" to .087").

Housing

N type

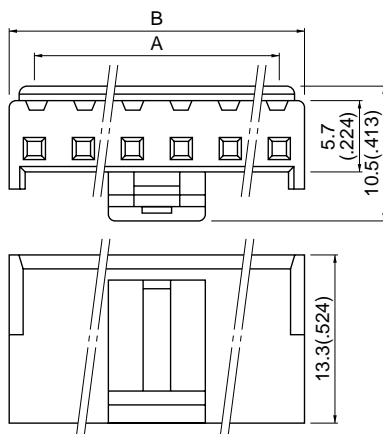

Cir- cuits	Model No.			Dimensions mm(in.)		Q'ty / bag
	N type	M type	Retainer mountable type	A	B	
2	VHR-2N	—	VHRR-2N	3.96(.156)	7.86(.309)	1,000
3	VHR-3N	VHR-3M	VHRR-3N	7.92(.312)	11.82(.465)	1,000
4	VHR-4N	VHR-4M	—	11.88(.468)	15.78(.621)	1,000
5	VHR-5N	VHR-5M	VHRR-5N	15.84(.624)	19.74(.777)	1,000
6	VHR-6N	VHR-6M	—	19.80(.780)	23.70(.933)	500
7	VHR-7N	VHR-7M	—	23.76(.935)	27.66(1.089)	500
8	VHR- 8N	—	VHRR-8N	27.72(1.091)	31.62(1.245)	500
9	VHR- 9N	VHR-9M	VHRR-9N	31.68(1.247)	35.58(1.401)	500
10	VHR-10N	—	—	35.64(1.403)	39.54(1.557)	500

Material

Nylon 6, UL94V-0, natural (white)

Note: 1. Models identified as VHR-() M incorporate measures to prevent electric shock and are thus safer in regard to high voltages.
2. Models VHRR-() N are not TÜV approved.

M type

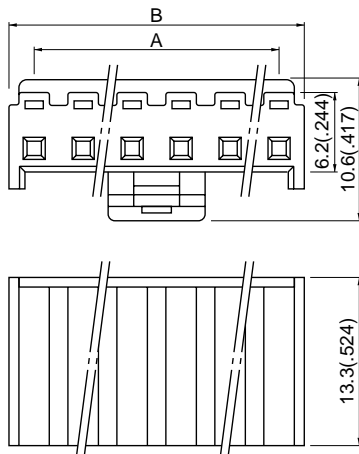

Retainer mountable type

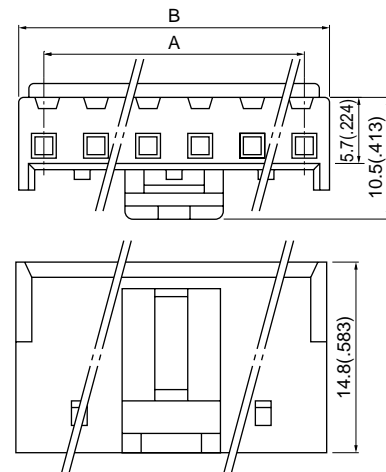

VH CONNECTOR

Retainer

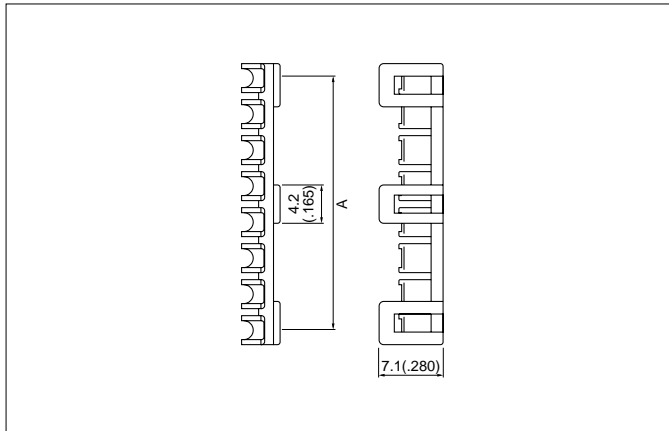

Circuits	Model No.	A	Q'ty / bag
2	VHS-2V	3.96(.156)	1,000
3	VHS-3V	7.52(.296)	1,000
5	VHS-5V	15.44(.608)	1,000
8	VHS-8V	27.32(1.076)	1,000
9	VHS-9V	31.28(1.231)	1,000

Material

Glass-filled nylon 66, UL94V-0, natural (ivory)

Note: Not CSA/TÜV approved.

Locking header

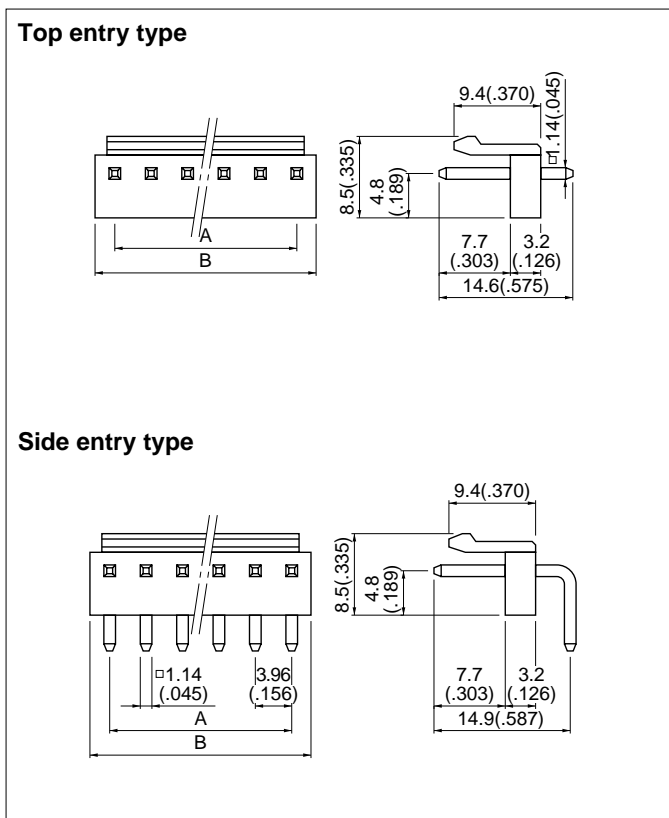

Circuits	Model No.		Dimensions mm(in.)		Q'ty / box	
	Top entry type	Side entry type	A	B	Top entry type	Side entry type
2	B 2P-VH	B 2PS-VH	3.96(.156)	7.86(.309)	1,000	1,000
3	B 3P-VH	B 3PS-VH	7.92(.312)	11.82(.465)	1,000	500
4	B 4P-VH	B 4PS-VH	11.88(.468)	15.78(.621)	500	500
5	B 5P-VH	B 5PS-VH	15.84(.624)	19.74(.777)	500	250
6	B 6P-VH	B 6PS-VH	19.80(.780)	23.70(.933)	250	250
7	B 7P-VH	B 7PS-VH	23.76(.935)	27.66(1.089)	250	250
8	B 8P-VH	B 8PS-VH	27.72(1.091)	31.62(1.245)	200	200
9	B 9P-VH	B 9PS-VH	31.68(1.247)	35.58(1.401)	200	200
10	B10P-VH	B10PS-VH	35.64(1.403)	39.54(1.557)	200	200

Material and Finish

Post: Brass, copper-undercoated, tin/lead-plated
Wafer: Nylon 66, UL94V-0, natural (white)

Note: Headers with a reduced number of posts are also available.
Contact JST for details.

VH CONNECTOR

Locking header

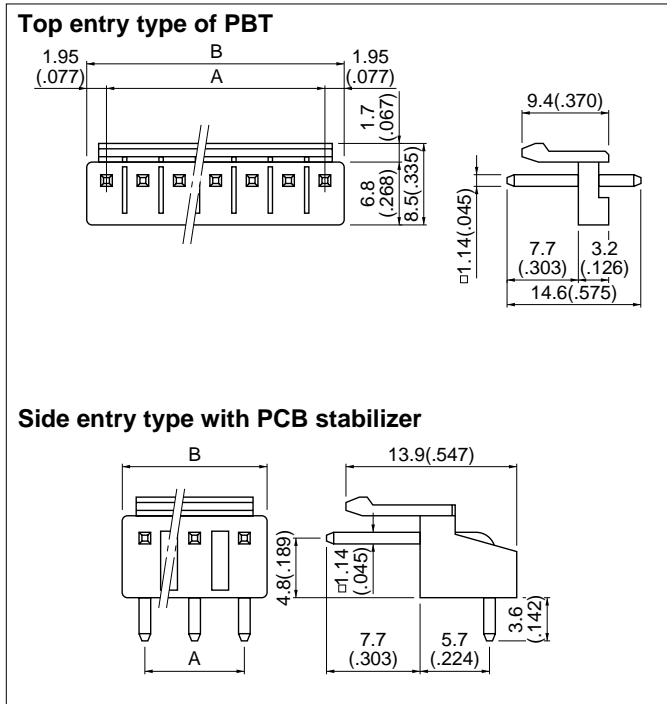

Circuits	Model No.		Dimensions mm(in.)		Q'ty / box	
	Top entry type of PBT	Side entry type with PCB stabilizer	A	B	Top entry type	Side entry type
2	B 2P-VH-B	S2P-VH	3.96(.156)	7.86(.309)	1,000	1,000
3	B 3P-VH-B	S3P-VH	7.92(.312)	11.82(.465)	500	500
4	B 4P-VH-B	S4P-VH	11.88(.468)	15.78(.621)	500	500
5	B 5P-VH-B	—	15.84(.624)	19.74(.777)	250	—
6	B 6P-VH-B	—	19.80(.780)	23.70(.933)	250	—
7	B 7P-VH-B	—	23.76(.935)	27.66(1.089)	250	—
8	B 8P-VH-B	—	27.72(1.091)	31.62(1.245)	200	—
9	B 9P-VH-B	—	31.68(1.247)	35.58(1.401)	200	—
10	B10P-VH-B	—	35.64(1.403)	39.54(1.557)	200	—

Material and Finish

Post: Brass, copper-undercoated, tin/lead-plated natural
 Wafer: Top entry type of PBT: Glass-filled PBT, UL94V-0, natural (ivory)
 Side entry type with PCB stabilizer: Nylon 66, UL94V-0, natural (white)

Shrouded header

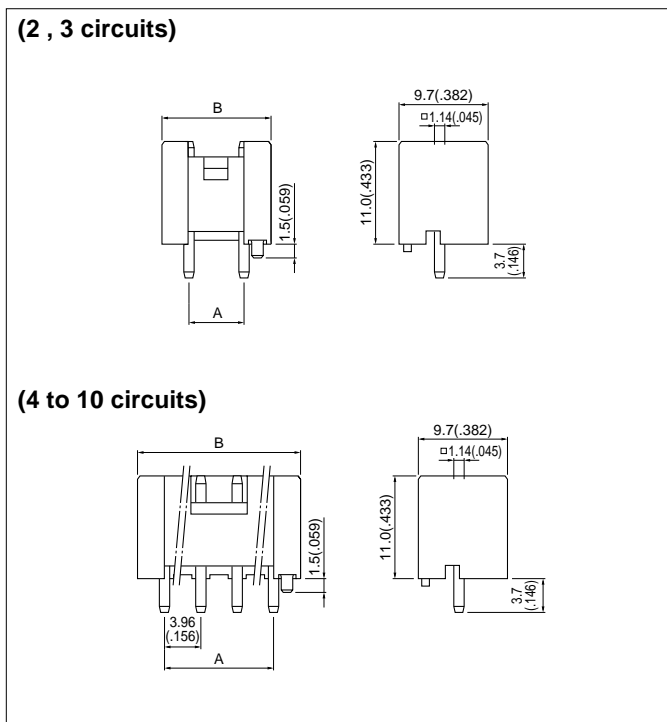

Circuits	Model No.	Dimensions mm(in.)		Q'ty / box
		A	B	
2	B 2P-VH-FB-B	3.96(.156)	9.80(.386)	250
3	B 3P-VH-FB-B	7.92(.312)	13.76(.542)	200
4	B 4P-VH-FB-B	11.88(.468)	17.72(.698)	—
5	B 5P-VH-FB-B	15.84(.624)	21.68(.854)	—
6	B 6P-VH-FB-B	19.80(.780)	25.64(1.009)	—
7	B 7P-VH-FB-B	23.76(.935)	29.60(1.165)	—
8	B 8P-VH-FB-B	27.72(1.091)	33.56(1.321)	—
9	B 9P-VH-FB-B	31.66(1.246)	37.52(1.477)	—
10	B10P-VH-FB-B	35.64(1.403)	41.48(1.633)	—

Material and Finish

Post: Brass, copper-undercoated, tin/lead-plated
 Wafer: Glass-filled PBT, UL94V-0, natural (white)

Note: Not CSA/TÜV approved.

VH CONNECTOR

PC board layout (viewed from soldering side) and Assembly layout

**Locking header
Top entry type**

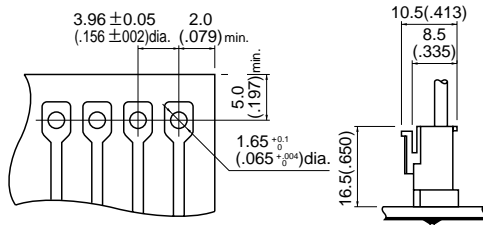

**Locking header
Side entry type**

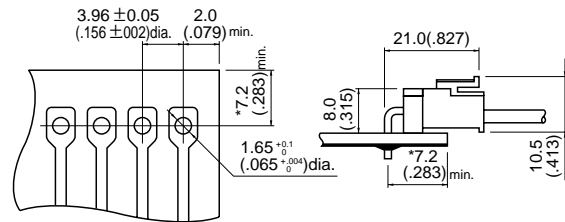

*11.0(.433) max. when used with the VR connector receptacle.

**Locking header
Side entry type with PCB stabilizer**

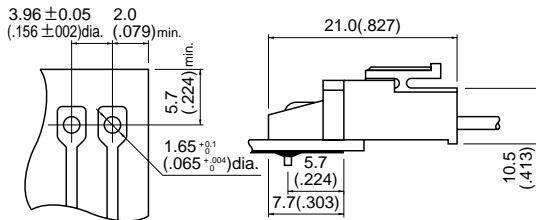

Shrouded header

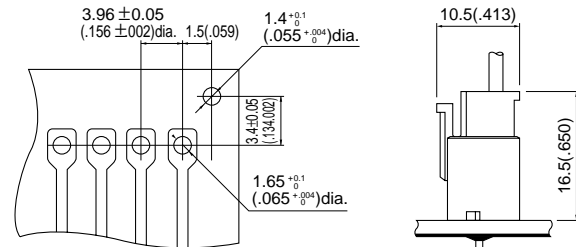

Note:

1. Tolerances are non-cumulative: $\pm 0.05\text{mm}(\pm .002)$ for all centers.
2. Hole dimensions differ according to the kind of PC board and piercing method. The dimensions above should serve as a guideline. Contact JST for details.