



Technical Data Sheet

3mm Infrared LED, T-1

IR204/H60

Features

- High reliability
- 2.54mm lead spacing
- Low forward voltage
- Good spectral matching to Si photodetector
- Pb free
- The product itself will remain within RoHS compliant version.

Descriptions

EVERLIGHT's infrared emitting diode (IR204/H60) is a high intensity diode, molded in a blue transparent plastic package. The device is spectrally matched with phototransistor, photodiode and infrared receive module.



Applications

- Infrared applied system

Device Selection Guide

LED Part No.	Chip	Lens Color
	Material	
IR204/H60	GaAlAs	Blue

Package Dimensions

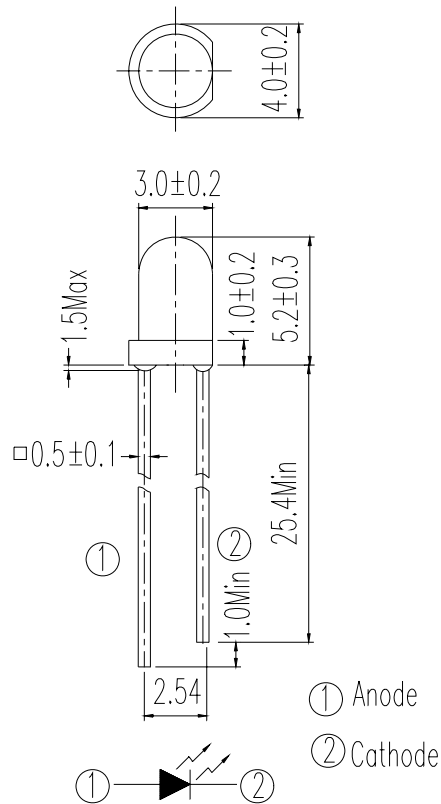

- Notes:** 1.All dimensions are in millimeters
2.Tolerances unless dimensions $\pm 0.25\text{mm}$

Absolute Maximum Ratings (Ta=25°C)

Parameter	Symbol	Rating	Units
Continuous Forward Current	I_F	100	mA
Peak Forward Current *1	I_{FP}	1.0	A
Reverse Voltage	V_R	5	V
Operating Temperature	T_{opr}	-40 ~ +85	°C
Storage Temperature	T_{stg}	-40 ~ +100	°C
Soldering Temperature *2	T_{sol}	260	°C
Power Dissipation at(or below) 25°C Free Air Temperature	P_d	150	mW

Notes: *1: I_{FP} Conditions--Pulse Width $\leq 100 \mu s$ and Duty $\leq 1\%$.

*2:Soldering time ≤ 5 seconds.

Electro-Optical Characteristics (Ta=25°C)

Parameter	Symbol	Condition	Min.	Typ.	Max.	Units
Radiant Intensity	I _E	I _F =20mA	4.0	7.0	--	mW/sr
		I _F =80mA	16	22	--	
		I _F =100mA	20	30	--	
		I _F =1A Pulse Width ≤ 100 μs and Duty ≤ 1%	--	300	--	
Peak Wavelength	λ _p	I _F =20mA	--	940	--	nm
Spectral Bandwidth	Δ λ	I _F =20mA	--	45	--	nm
Forward Voltage	V _F	I _F =20mA	--	1.2	1.5	V
		I _F =100mA	--	1.4	1.8	
		I _F =1A Pulse Width ≤ 100 μs and Duty ≤ 1%	--	2.6	4.0	
Reverse Current	I _R	V _R =5V	--	--	10	μA
View Angle	2 θ 1/2	I _F =20mA	37	50	63	deg

Typical Electro-Optical Characteristics Curves

Fig.1 Forward Current vs. Ambient Temperature

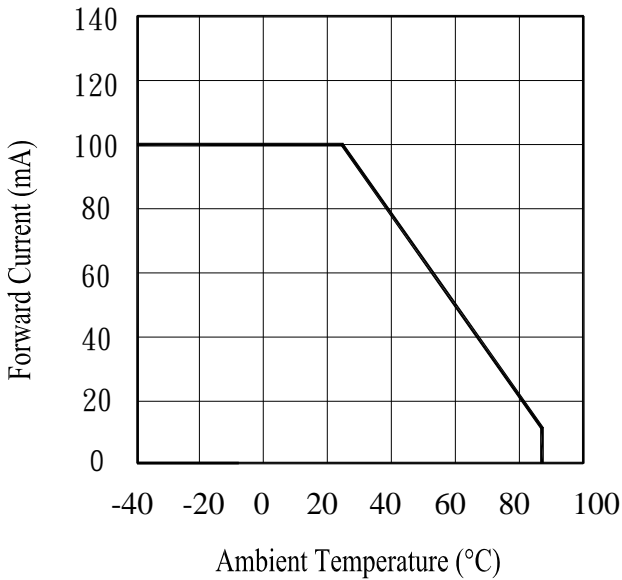

Fig.2 Spectral Distribution

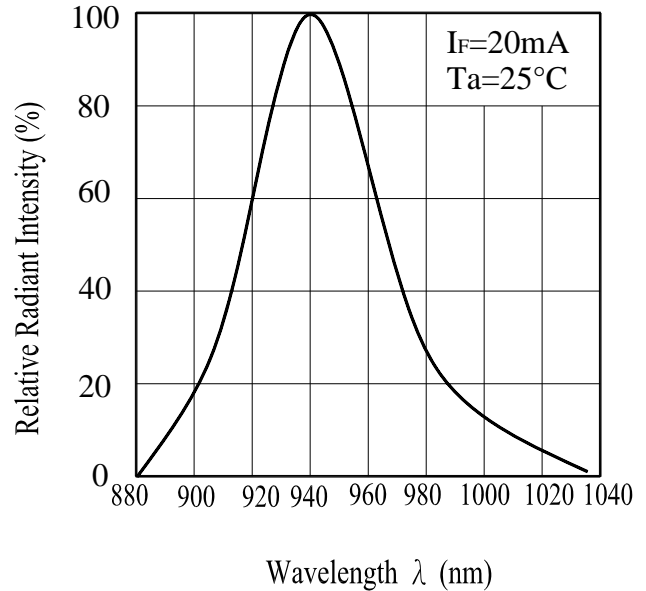

Fig.3 Peak Emission Wavelength vs. Ambient Temperature

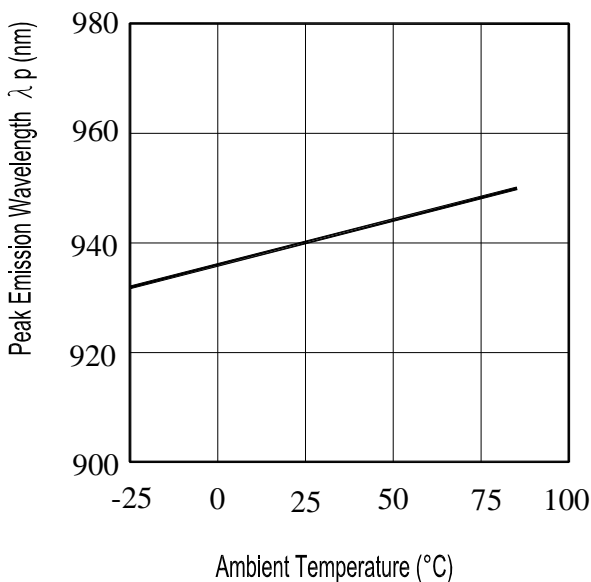
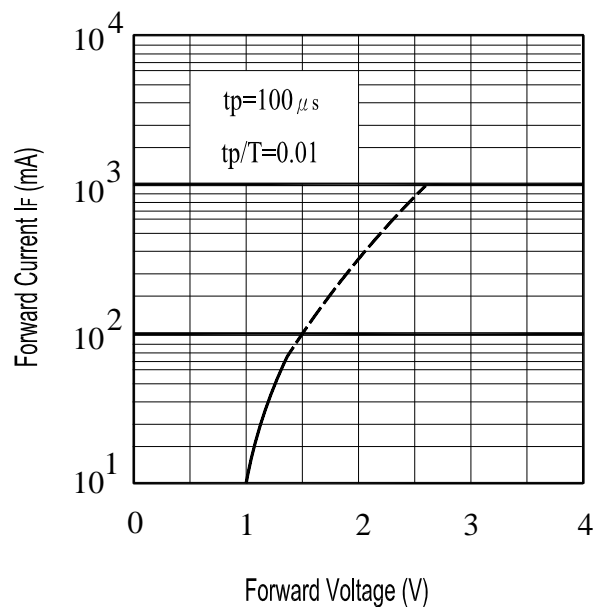

Fig.4 Forward Current vs. Forward Voltage



Typical Electro-Optical Characteristics Curves

Fig.5 Relative Intensity vs.

Forward Current

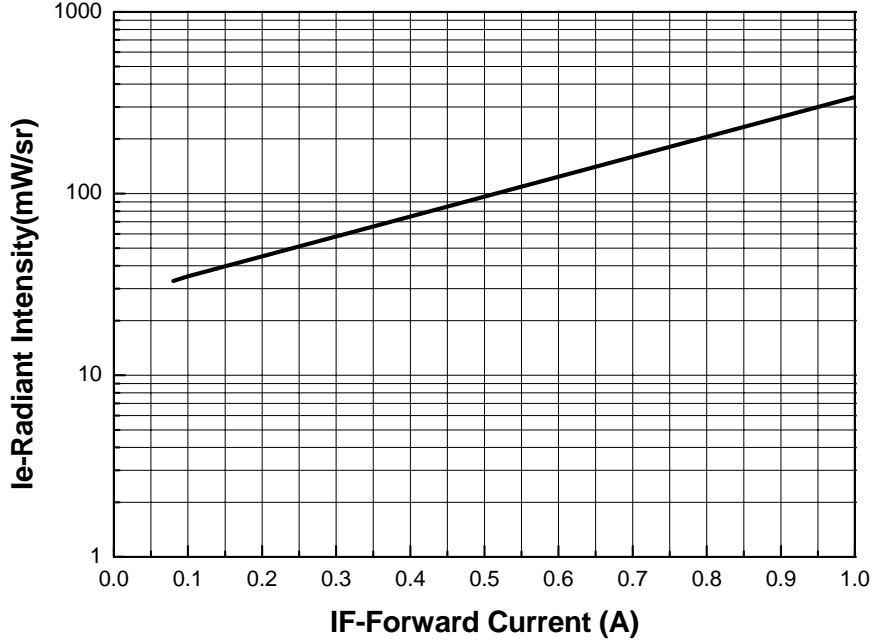
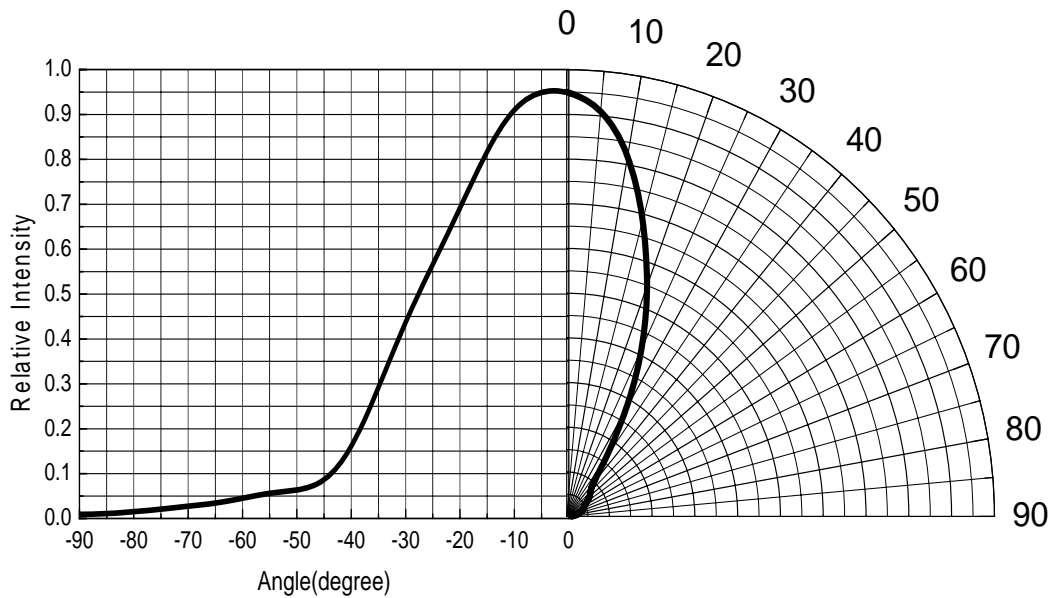

Fig.6 Relative Radiant Intensity vs.

Angular Displacement





Packing Quantity Specification

- 1. 1000PCS/1Bag , 4Bags/1Box
- 2. 10Boxes/1Carton

Label Form Specification

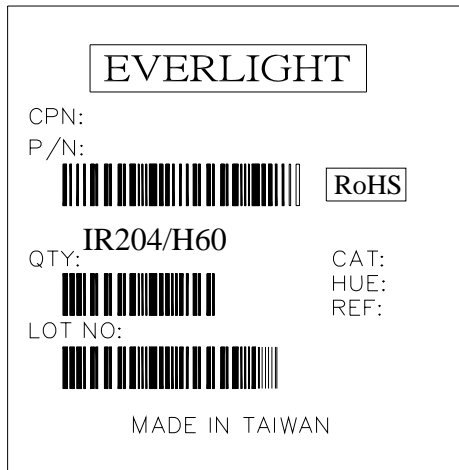

CPN: Customer's Production Number
P/N : Production Number
QTY: Packing Quantity
CAT: Ranks
HUE: Peak Wavelength
REF: Reference
LOT No: Lot Number
MADE IN TAIWAN: Production Place

Notes

- 1. Above specification may be changed without notice. EVERLIGHT will reserve authority on material change for above specification.
- 2. When using this product, please observe the absolute maximum ratings and the instructions for using outlined in these specification sheets. EVERLIGHT assumes no responsibility for any damage resulting from use of the product which does not comply with the absolute maximum ratings and the instructions included in these specification sheets.
- 3. These specification sheets include materials protected under copyright of EVERLIGHT corporation. Please don't reproduce or cause anyone to reproduce them without EVERLIGHT's consent.

EVERLIGHT ELECTRONICS CO., LTD. <i>Office: No 25, Lane 76, Sec 3, Chung Yang Rd, Tucheng, Taipei 236, Taiwan, R.O.C</i>	<i>Tel: 886-2-2267-2000, 2267-9936 Fax: 886-2267-6244, 2267-6189, 2267-6306 http://www.everlight.com</i>
---	---