

ROCKER SWITCHES

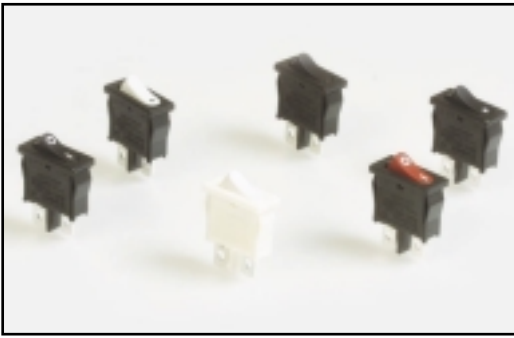

SPECIFICATIONS

Rating:	10A@125 VAC, 6A@250 VAC (UL, CUL) 4(1)A @250 VAC (D, S, N, Fi, VDE)
Mechanical Life:	≥50,000 cycles
Electrical Life:	≥10,000 cycles
Contact Resistance:	<20 mΩ (Initial)
Insulation Resistance:	>1,000MΩ @ 500V DC
Dielectric Strength:	>1,500V AC 1 minute (Initial) >3,000V between poles
Safety Std. Approval:	UL, CSA, VDE, Semko, Nemko, Demko, Fimko

MATERIALS

Body:	Nylon 66 (UL94 V-2)
Rocker:	Nylon 66 (UL94 V-2)
Contact Surface:	Coin Silver
Terminal:	Silver plated copper alloy



HOW TO ORDER

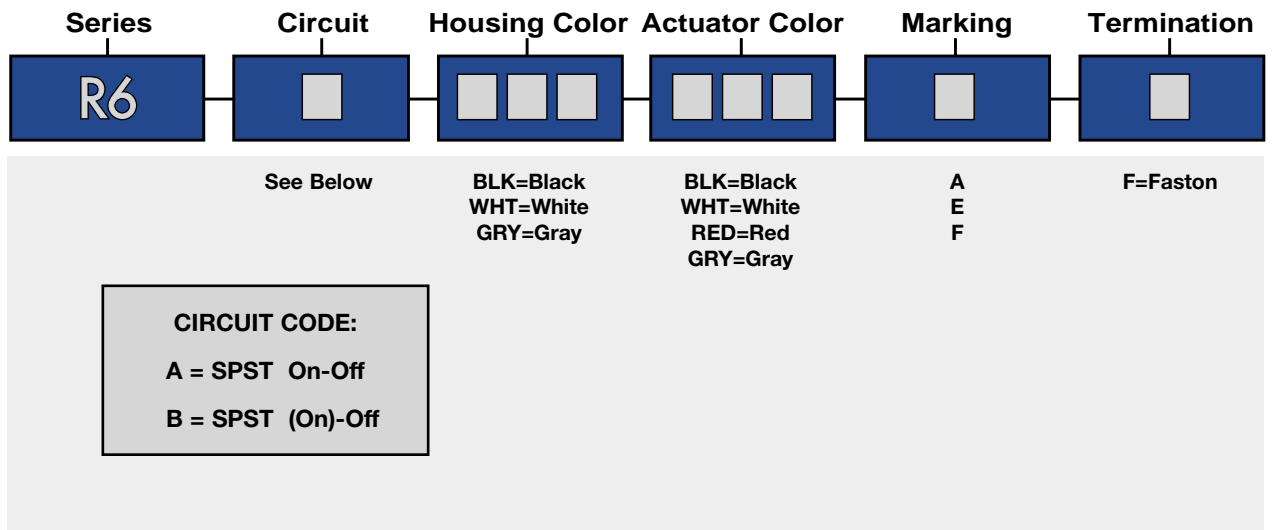

EXAMPLE

R6 → A → BLK → BLK → E → F



SPST

Circuit Code	POS 1	POS 2
A	ON	OFF
B	(ON)	OFF
Term. Comm.	1-1a	OPEN

Schematic () = Momentary

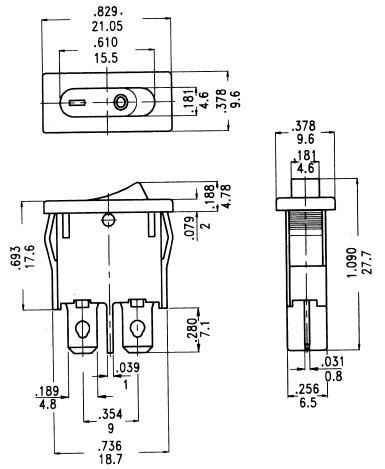
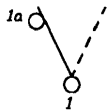

PANEL MOUNTING

TERMINATION OPTIONS

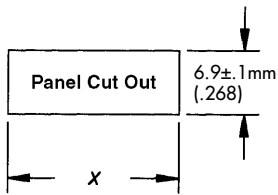

Panel Thickness	mm (inch)
.75 - 1.25 (.030)-(.049)	19.3±.1 (.756)
1.25 - 2.00 (.049)-(.079)	19.5±.1 (.764)
2.00 - 3.00 (.079)-(.118)	19.9±.1 (.780)

F Faston

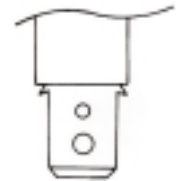

0.81 (.032) THK terminals designed for Quick Connect connectors available from AMP Industries, Harrisburg, PA 17105. (Or equivalent).

MARKING OPTIONS

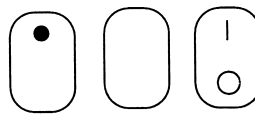

A E F

SPECIFICATIONS SUBJECT TO CHANGE WITHOUT NOTICE.