

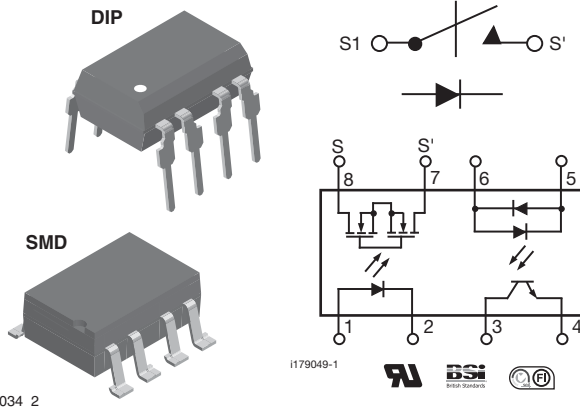

# Telecom Switch 1 Form A Solid-State Relay



RoHS COMPLIANT

## FEATURES

- Solid state relay and optocoupler in one package
- Surface mount package
- I/O isolation, 5300 V<sub>RMS</sub>
- LH1529A, CTR Min. = 33 %
- LH1529B, CTR Min. = 100 %
- Optocoupler
  - Bidirectional current detection
- Solid-state relay (equivalent to TS117P)
  - Typical R<sub>ON</sub> 20 Ω
  - Load voltage 350 V
  - Load current 120 mA
  - Current limit protection
  - High surge capability
  - Clean bounce free switching
  - Low power consumption
  - High reliability monolithic receptor
- Compliant to RoHS Directive 2002/95/EC and in accordance to WEEE 2002/96/EC

## DESCRIPTION

The LH1529A and LH1529B telecom switches consist of an optically coupled solid state relay (SSR) and bidirectional input optocoupler. The SSR is ideal for performing switch hook and dial-pulse switching whilst optocoupler performs ring detection and loop current sensing functions. Both the SSR and optocoupler have an isolation test voltage of 5300 V<sub>RMS</sub>.

## AGENCY APPROVALS

- UL1577: file no. E52744 system code H, double protection
- BSI/BABT: certification no. 7980
- FIMKO: approval

## APPLICATIONS

- General telecom switching
  - On/off hook control
  - Dial pulse
  - Ring current detection
  - Loop current sensing

### Note

- See “solid-state relays” (application note 56)

ORDERING INFORMATION													
L	H	1	5	2	9	#	#	#	T	R			
PART NUMBER						ELECTR. VARIATION	PACKAGE CONFIG.			TAPE AND REEL			
<b>PACKAGE</b>						<b>UL, BSI, FIMKO</b>							
SMD-8, tubes						LH1529AAC							
SMD-8, tape and reel						LH1529AACTR							
SMD-8, tubes						LH1529BAC							
SMD-8, tape and reel						LH1529BACTR							
DIP-8, tubes						LH1529BB							



ABSOLUTE MAXIMUM RATINGS (T <sub>amb</sub> = 25 °C, unless otherwise specified)				
PARAMETER	TEST CONDITION	SYMBOL	VALUE	UNIT
<b>SSR</b>				
<b>INPUT</b>				
LED continuous forward current		I <sub>F</sub>	50	mA
LED reverse voltage	I <sub>R</sub> ≤ 10 μA	V <sub>R</sub>	5	V
<b>OUTPUT</b>				
DC or peak AC load voltage	I <sub>L</sub> ≤ 50 μA	V <sub>L</sub>	350	V
Continuous DC load current		I <sub>L</sub>	120	mA
<b>SSR</b>				
Total power dissipation		P <sub>diss</sub>	600	mW
Ambient temperature range		T <sub>amb</sub>	- 40 to + 85	°C
Storage temperature range		T <sub>stg</sub>	- 40 to + 150	°C
Soldering temperature <sup>(1)</sup>	t = 10 s max.	T <sub>sld</sub>	260	°C
Isolation test voltage (for 1 s)		V <sub>ISO</sub>	5300	V <sub>RMS</sub>
Isolation resistance	V <sub>IO</sub> = 500 V, T <sub>amb</sub> = 25 °C	R <sub>IO</sub>	≥ 10 <sup>12</sup>	Ω
	V <sub>IO</sub> = 500 V, T <sub>amb</sub> = 100 °C	R <sub>IO</sub>	≥ 10 <sup>11</sup>	Ω
<b>OPTOCOUPLER</b>				
<b>INPUT</b>				
LED continuous forward current		I <sub>F</sub>	50	mA
LED reverse voltage	I <sub>R</sub> ≤ 10 μA	V <sub>R</sub>	5	V
<b>OUTPUT</b>				
Collector emitter breakdown voltage		BV <sub>CEO</sub>	30	V
Phototransistor power dissipation		P <sub>diss</sub>	150	mW

**Notes**

- Stresses in excess of the absolute maximum ratings can cause permanent damage to the device. Functional operation of the device is not implied at these or any other conditions in excess of those given in the operational sections of this document. Exposure to absolute maximum ratings for extended periods of the time can adversely affect reliability.

<sup>(1)</sup> Refer to reflow profile for soldering conditions for surface mounted devices (SMD). Refer to wave profile for soldering conditions for through hole devices (DIP).

ELECTRICAL CHARACTERISTICS (T <sub>amb</sub> = 25 °C, unless otherwise specified)							
PARAMETER	TEST CONDITION	PART	SYMBOL	MIN.	TYP.	MAX.	UNIT
<b>SSR</b>							
<b>INPUT</b>							
LED forward current switch turn-on	I <sub>L</sub> = 100 mA, t = 10 ms		I <sub>Fon</sub>		0.7	2	mA
LED forward current switch turn-off	V <sub>L</sub> = ± 300 V		I <sub>Foff</sub>	0.2	0.6		mA
LED forward voltage	I <sub>F</sub> = 10 mA		V <sub>F</sub>	1.15	1.26	1.45	V
<b>OUTPUT</b>							
On-resistance AC/DC, pins 4 (±) to 6 (±)	I <sub>F</sub> = 5 mA, I <sub>L</sub> = ± 50 mA		R <sub>ON</sub>	12	20	25	Ω
Current limit	I <sub>F</sub> = 5 mA, t = 5 ms, V <sub>L</sub> = ± 6 V	LH1529AAC, LH1529AACTR	I <sub>limit</sub>	230	260	370	mA
		LH1529BB	I <sub>limit</sub>	170	210	250	mA
		LH1529BAC, LH1529BACTR	I <sub>limit</sub>	170	210	250	mA
Off-state leakage current	I <sub>F</sub> = 0 mA, V <sub>L</sub> = ± 100 V		I <sub>O</sub>		0.02	200	nA
	I <sub>F</sub> = 0 mA, V <sub>L</sub> = ± 350 V		I <sub>O</sub>			1	μA
Output capacitance pin 7 to pin 8	I <sub>F</sub> = 0 mA, V <sub>L</sub> = 1 V		C <sub>O</sub>		55		pF
	I <sub>F</sub> = 0 mA, V <sub>L</sub> = 50 V		C <sub>O</sub>		10		pF
Capacitance (input to output)	V <sub>ISO</sub> = 1 V		C <sub>IO</sub>		1.3		pF



ELECTRICAL CHARACTERISTICS (T <sub>amb</sub> = 25 °C, unless otherwise specified)							
PARAMETER	TEST CONDITION	PART	SYMBOL	MIN.	TYP.	MAX.	UNIT
<b>OPTOCOUPLER</b>							
LED forward current	I <sub>F</sub> = 10 mA		V <sub>F</sub>	0.9	1.2	1.5	V
Saturation voltage	I <sub>F</sub> = 16 mA, I <sub>C</sub> = 2 mA		V <sub>CEsat</sub>		0.7	0.5	V
Collector emitter dark current	I <sub>F</sub> = 0 mA, V <sub>CE</sub> = 5 V		I <sub>CEO</sub>			500	nA
Trickle current leakage	I <sub>F</sub> = 5 μA, V <sub>CE</sub> = 5 V		I <sub>CEO</sub>			1	μA
DC current transfer ratio	I <sub>F</sub> = 6 mA, V <sub>CE</sub> = 0.5 V	LH1529AAC, LH1529AACTR	CTR <sub>DC</sub>	33	100		%
		LH1529BB	CTR <sub>DC</sub>	100	165		%
		LH1529BAC, LH1529BACTR	CTR <sub>DC</sub>	100	165		%

**Note**

- Minimum and maximum values are testing requirements. Typical values are characteristics of the device and are the result of engineering evaluations. Typical values are for information only and are not part of the testing requirements.

SWITCHING CHARACTERISTICS (T <sub>amb</sub> = 25 °C, unless otherwise specified)							
PARAMETER	TEST CONDITION	PART	SYMBOL	MIN.	TYP.	MAX.	UNIT
Turn-on time	I <sub>F</sub> = 5 mA, I <sub>L</sub> = 50 mA	LH1529AAC, LH1529AACTR	t <sub>on</sub>		2	3	ms
		LH1529BB	t <sub>on</sub>		1.3	2.5	ms
		LH1529BAC, LH1529BACTR	t <sub>on</sub>		1.3	2.5	ms
Turn-off time	I <sub>F</sub> = 5 mA, I <sub>L</sub> = 50 mA	LH1529AAC, LH1529AACTR	t <sub>off</sub>		0.6	3	ms
		LH1529BB	t <sub>off</sub>		0.6	2.5	ms
		LH1529BAC, LH1529BACTR	t <sub>off</sub>		0.6	2.5	ms

**TYPICAL CHARACTERISTICS** (T<sub>amb</sub> = 25 °C, unless otherwise specified)

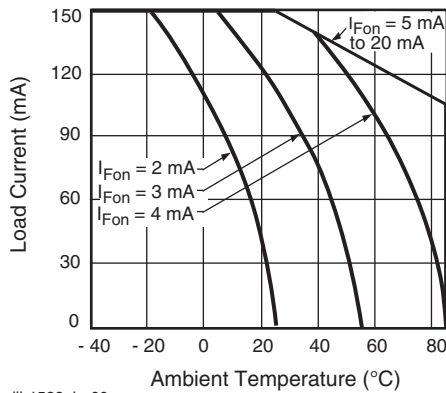

Fig. 1 - Recommended Operating Conditions

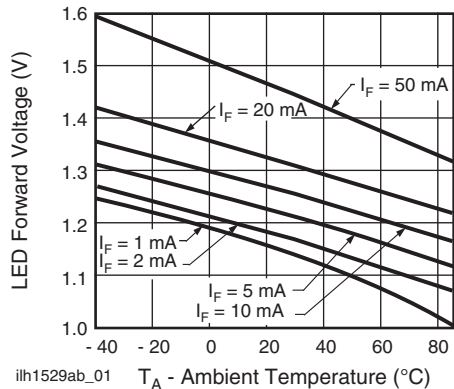

Fig. 2 - LED Voltage vs. Temperature

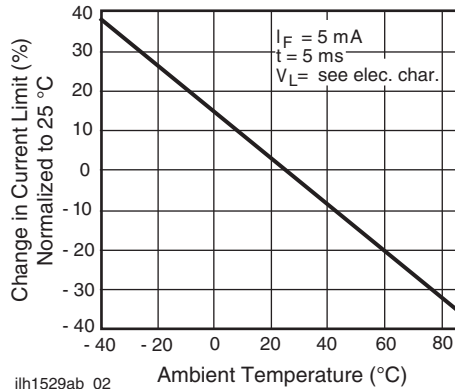

Fig. 3 - Current Limit vs. Temperature

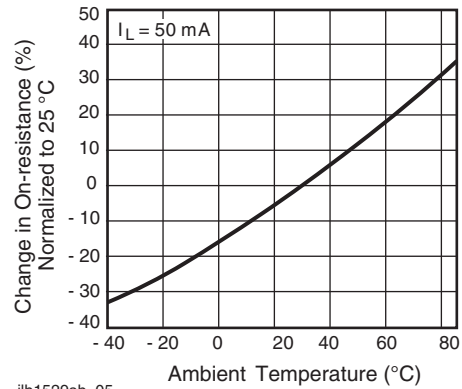

Fig. 6 - On-Resistance vs. Temperature

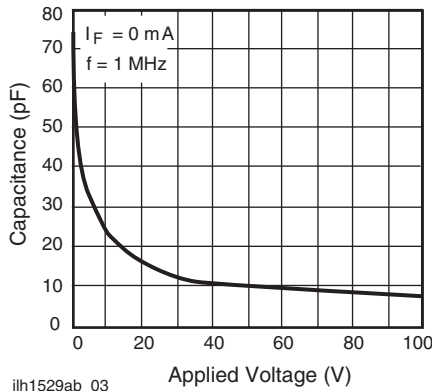

Fig. 4 - Switch Capacitance vs. Applied Voltage

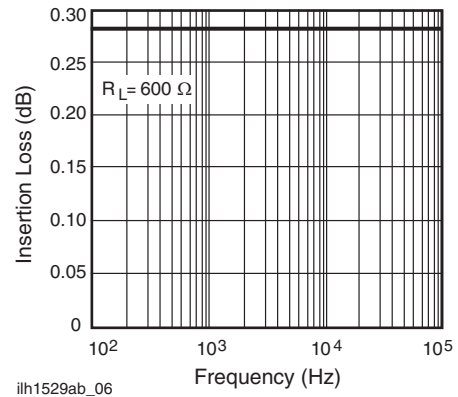

Fig. 7 - Insertion Loss vs. Frequency

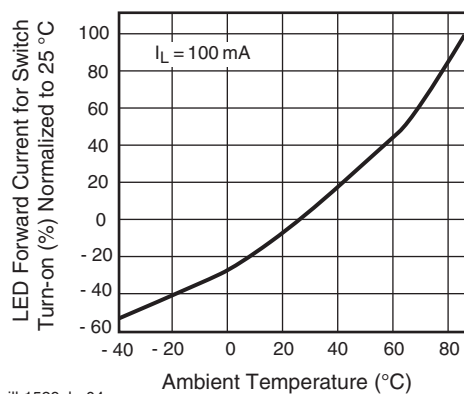

Fig. 5 - LED Current for Switch Turn-on vs. Temperature

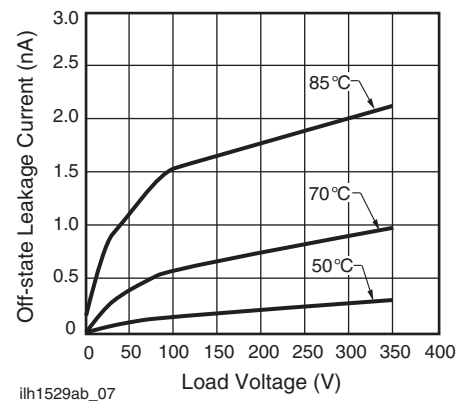

Fig. 8 - Leakage Current vs. Applied Voltage at Elevated Temperatures

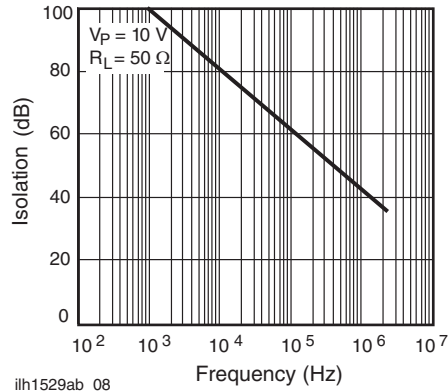

Fig. 9 - Output Isolation

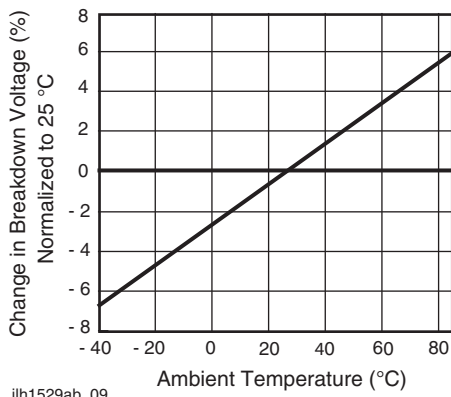

Fig. 10 - Switch Breakdown Voltage vs. Temperature

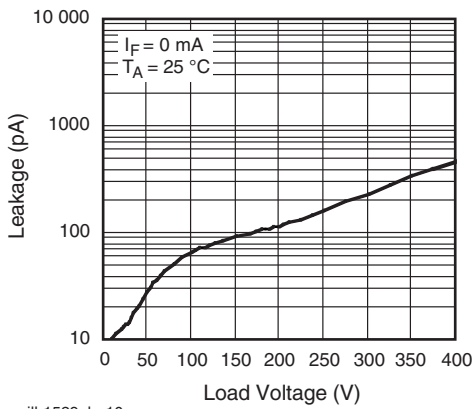
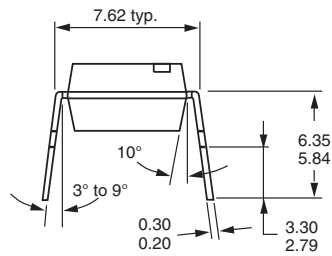
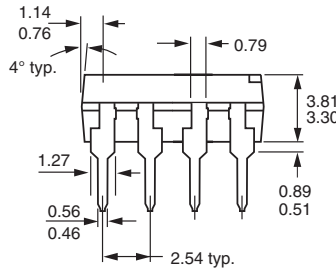
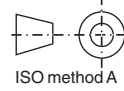
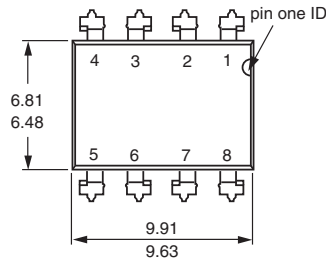

Fig. 11 - Leakage Current vs. Applied Voltage



PACKAGE DIMENSIONS in millimeters

DIP



i178008

SMD

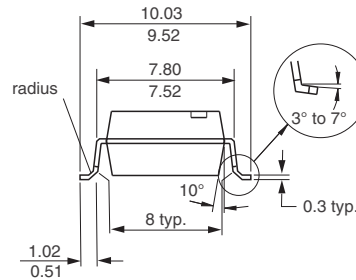
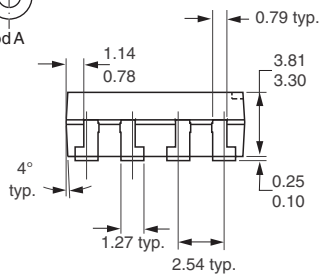
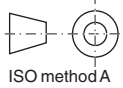
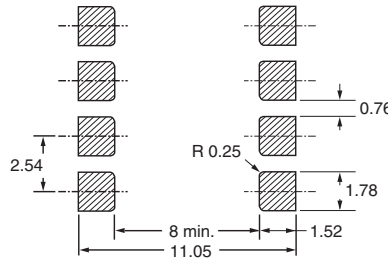
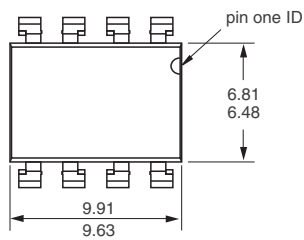

i178009

PACKAGE MARKING (example)

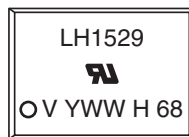

Note

- Tape and reel suffix (TR) is not part of the package marking.



## Disclaimer

ALL PRODUCT, PRODUCT SPECIFICATIONS AND DATA ARE SUBJECT TO CHANGE WITHOUT NOTICE TO IMPROVE RELIABILITY, FUNCTION OR DESIGN OR OTHERWISE.

Vishay Intertechnology, Inc., its affiliates, agents, and employees, and all persons acting on its or their behalf (collectively, "Vishay"), disclaim any and all liability for any errors, inaccuracies or incompleteness contained in any datasheet or in any other disclosure relating to any product.

Vishay makes no warranty, representation or guarantee regarding the suitability of the products for any particular purpose or the continuing production of any product. To the maximum extent permitted by applicable law, Vishay disclaims (i) any and all liability arising out of the application or use of any product, (ii) any and all liability, including without limitation special, consequential or incidental damages, and (iii) any and all implied warranties, including warranties of fitness for particular purpose, non-infringement and merchantability.

Statements regarding the suitability of products for certain types of applications are based on Vishay's knowledge of typical requirements that are often placed on Vishay products in generic applications. Such statements are not binding statements about the suitability of products for a particular application. It is the customer's responsibility to validate that a particular product with the properties described in the product specification is suitable for use in a particular application. Parameters provided in datasheets and/or specifications may vary in different applications and performance may vary over time. All operating parameters, including typical parameters, must be validated for each customer application by the customer's technical experts. Product specifications do not expand or otherwise modify Vishay's terms and conditions of purchase, including but not limited to the warranty expressed therein.

Except as expressly indicated in writing, Vishay products are not designed for use in medical, life-saving, or life-sustaining applications or for any other application in which the failure of the Vishay product could result in personal injury or death. Customers using or selling Vishay products not expressly indicated for use in such applications do so at their own risk and agree to fully indemnify and hold Vishay and its distributors harmless from and against any and all claims, liabilities, expenses and damages arising or resulting in connection with such use or sale, including attorneys fees, even if such claim alleges that Vishay or its distributor was negligent regarding the design or manufacture of the part. Please contact authorized Vishay personnel to obtain written terms and conditions regarding products designed for such applications.

No license, express or implied, by estoppel or otherwise, to any intellectual property rights is granted by this document or by any conduct of Vishay. Product names and markings noted herein may be trademarks of their respective owners.