

# ALUMINUM ELECTROLYTIC CAPACITORS

**NT** Screw Terminal Type, 105°C Standard  
series



- Load life of 5,000 hours (2,000 hours for 10~250V,500V) application of rated ripple current at +105°C.
- Extended voltage range from 10V up to 500V.
- Extended range up to φ100 × 250L 2size.
- Compliant to the RoHS directive (2002/95/EC).

NT



## Specifications

Item	Performance Characteristics												
Category Temperature Range	- 40 to +105°C (10 to 100V) , - 25 to +105°C (160 to 500V)												
Rated Voltage Range	10 to 500V												
Rated Capacitance Range	220 to 1500000µF												
Capacitance Tolerance	±20% at 120Hz, 20°C												
Leakage Current	After 5 minutes' application of rated voltage, leakage current is not more than $3\sqrt{CV}$ (µA) or 5mA, whichever is smaller. (at 20°C) [C:Rated Capacitance (µF) , V:Voltage(V)]												
Tangent of loss angle (tan δ) (MAX)	Measurement frequency:120Hz, Temperature:20°C												
	φD 35	V 10	16	25	35	50	63	80	100	160 to 250	350 to 500		
		80 to 100	0.65	0.45	0.4	0.3	0.25	0.25	0.2	0.12	0.15	0.2	
	51	80 to 100	0.8	0.6	0.5	0.4	0.25	0.25	0.2	0.15	0.15	0.2	
		120	0.85	0.6	0.5	0.4	0.3	—	—	—	—	0.2	
	63.5	100	—	—	0.65	—	0.35	0.3	0.25	0.2	0.2	0.2	
		110 to 130	1.2	0.8	0.7	0.5	0.35	0.3	—	—	0.2	0.2	
	76.2	100	2.0	1.2	0.9	0.7	0.55	0.5	0.3	0.3	—	0.2	
		120 to 150	2.0	1.2	0.9	0.7	0.55	0.5	0.35	0.3	0.2	0.2	
	90	140 to 220	2.4	2.0	1.5	1.0	0.75	0.6	0.4	0.3	0.25	0.2	
220 • 250		2.4	2.0	1.5	1.0	0.75	0.6	0.4	0.3	0.25	0.2		
Stability at Low Temperature	Rated voltage(V)		10 to 100		160 to 500		Measurement frequency : 120Hz						
	Impedance ratio ZT/Z20(MAX.)	Z - 25°C/Z+20°C	—		8								
		Z - 40°C/Z+20°C	12		—								
Endurance	The specifications listed at right shall be met when the capacitors are restored to 20°C after D.C. bias plus rated ripple current is applied for 5000 hours (2000 hours for 10 to 250V/500V) at 105°C, the peak voltage shall not exceed the rated voltage.						Capacitance change	Within ±20% of the initial capacitance value					
							tan δ	300% or less than the initial specified value					
							Leakage current	Less than or equal to the initial specified value					
Shelf Life	After storing the capacitors under no load at 105°C for 1000 hours and then performing voltage treatment based on JIS C 5101-4 clause 4.1 at 20°C, they shall meet the requirements listed at right.						Capacitance change	Within ±20% of the initial capacitance value					
							tan δ	300% or less than the initial specified value					
							Leakage current	Less than or equal to the initial specified value					
Marking	Printed with white color letter on black sleeve.												

## Drawing

φ35 Screw terminal type

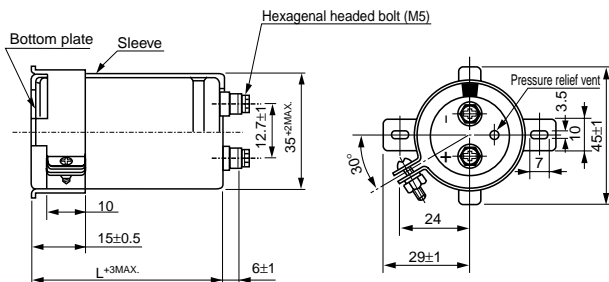

## Type numbering system

Voltage 250V or less (Example : 250V 3300µF)

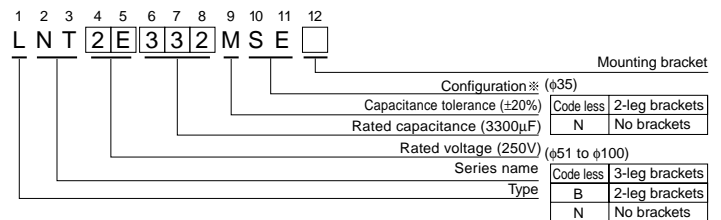

Voltage 350V or more (Example : 450V 2200µF)

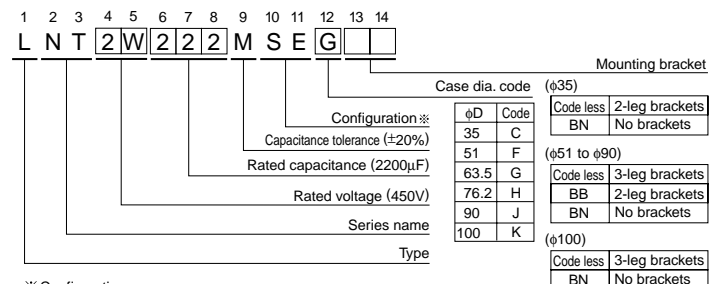

※ Configuration

Cr (III) Plating (RoHS compliant)
SE

Resin bushing available upon request.

※ Please contact to us if PVC less products are required.

● Dimension table in next page.

## NT series

Screw terminal type for  $\phi 51$  and larger

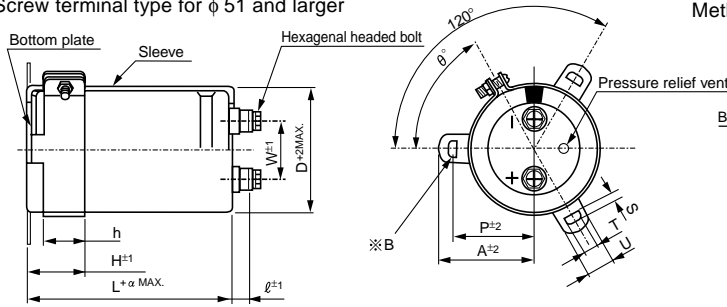

Method to mount resin bushing ( $\phi 76.2$ ) (Apply to L=150 or more)

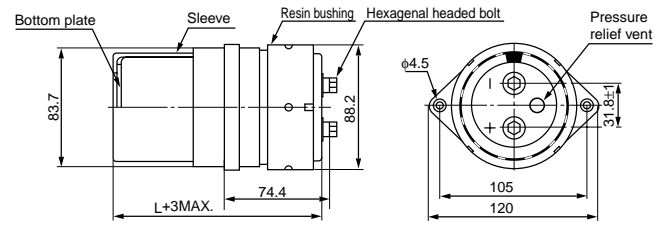

Method to mount resin bushing ( $\phi 90$ ) (Apply to L=150 or more)

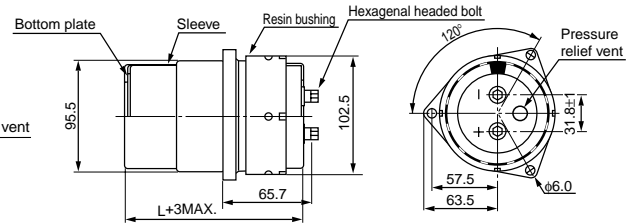

※B  
3-leg brackets for  $\phi 90$  capacitors have different hole shapes from the ordinary ones as illustrated below.

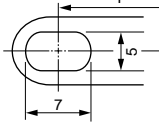

● Dimension of terminal pitch (W) and length ( $\ell$ ) and Nominal dia. of bolt (mm)

$\phi D$	W	$\ell$	$\alpha$	Nominal. of bolt
51	22.0	6	3	M5
63.5	28.6	6	3	M5
76.2	31.8	6	3	M5
90	31.8	6	3	M5
100	41.5	10	4	M8

● Dimensions of mounting bracket (mm)

Symbol	Leg Shape $\phi D$	3-Legs					2-Legs			
		51	63.5	76.2	90	100	51	63.5	76.2	90
P		32.5	38.1	44.5	50.8	56.3	33.2	40.5	46.5	53
A		38.5	43	49.2	58.5	62	40	46.5	53	59
T		7.5	8.0	7.0	8.0	8.0	6.0	7.0	6.0	6.0
S		5.0	5.0	5.0	5.0	5.0	4.5	4.5	4.5	4.5
U		12	14	14	18	16	14	14	14	14
$\theta^\circ$		60	60	60	60	60	30	30	30	30
H		20	25	30	35	36	25	35	35	35
h		15	20	24	25	30	15	20	20	20

### Dimensions

10V (1A)					
Cap. ( $\mu F$ )	Size $\phi D \times L$ (mm)	Rated ripple (Arms)	$\tan \delta$	Leakage Current (mA)	Code
33000	35×80	4.8	0.65	1.72	LNT1A333MSE
47000	35×100	6.2	0.65	2.05	LNT1A473MSE
68000	51×80	6.8	0.80	2.47	LNT1A683MSE
100000	51×100	8.6	0.80	3.00	LNT1A104MSE
150000	51×120	10.8	0.85	3.67	LNT1A154MSE
220000	63.5×120	13.2	1.20	4.44	LNT1A224MSE
330000	76.2×120	15.8	2.00	5.00	LNT1A334MSE
470000	90×140	17.0	2.40	5.00	LNT1A474MSE
680000	90×170	18.4	2.40	5.00	LNT1A684MSE
1000000	90×220	20.1	2.40	5.00	LNT1A105MSE
1500000	100×220	22.1	2.40	5.00	LNT1A155MSE

16V (1C)					
Cap. ( $\mu F$ )	Size $\phi D \times L$ (mm)	Rated ripple (Arms)	$\tan \delta$	Leakage Current (mA)	Code
33000	35×80	5.2	0.45	2.17	LNT1C333MSE
47000	35×100	6.8	0.45	2.60	LNT1C473MSE
68000	51×80	7.1	0.60	3.12	LNT1C683MSE
100000	51×100	9.6	0.60	3.79	LNT1C104MSE
150000	51×120	11.0	0.60	4.64	LNT1C154MSE
220000	63.5×120	14.1	0.80	5.00	LNT1C224MSE
330000	76.2×120	20.6	1.20	5.00	LNT1C334MSE
470000	90×140	22.1	2.00	5.00	LNT1C474MSE
680000	90×170	24.0	2.00	5.00	LNT1C684MSE
1000000	90×220	26.1	2.00	5.00	LNT1C105MSE
1500000	100×250	28.8	2.00	5.00	LNT1C155MSE

Rated ripple current (Arms) at 105°C 120Hz

### ■Dimensions

25V (1E)					
Cap. (μF)	Size φD × L(mm)	Rated ripple (Arms)	tan δ	Leakage Current (mA)	Code
22000	35×80	4.9	0.40	2.22	LNT1E223MSE
33000	35×100	6.2	0.40	2.72	LNT1E333MSE
47000	51×80	8.3	0.50	3.25	LNT1E473MSE
68000	51×120	10.2	0.50	3.91	LNT1E683MSE
100000	63.5×100	11.5	0.65	4.74	LNT1E104MSE
150000	63.5×120	13.8	0.70	5.00	LNT1E154MSE
220000	76.2×120	17.0	0.90	5.00	LNT1E224MSE
330000	90×140	20.8	1.50	5.00	LNT1E334MSE
470000	90×170	22.4	1.50	5.00	LNT1E474MSE
680000	90×220	24.2	1.50	5.00	LNT1E684MSE
1000000	100×220	26.4	1.50	5.00	LNT1E105MSE

35V (1V)					
Cap. (μF)	Size φD × L(mm)	Rated ripple (Arms)	tan δ	Leakage Current (mA)	Code
10000	35×80	4.7	0.30	1.77	LNT1V103MSE
15000	35×80	5.1	0.30	2.17	LNT1V153MSE
22000	35×100	5.6	0.30	2.63	LNT1V223MSE
33000	51×80	7.4	0.40	3.22	LNT1V333MSE
47000	51×100	8.4	0.40	3.84	LNT1V473MSE
68000	51×120	12.3	0.40	4.62	LNT1V683MSE
100000	63.5×120	13.6	0.50	5.00	LNT1V104MSE
150000	76.2×120	15.1	0.70	5.00	LNT1V154MSE
220000	90×140	17.4	1.00	5.00	LNT1V224MSE
330000	90×170	21.3	1.00	5.00	LNT1V334MSE
470000	90×220	25.4	1.00	5.00	LNT1V474MSE
680000	100×250	27.5	1.00	5.00	LNT1V684MSE

50V (1H)					
Cap. (μF)	Size φD × L(mm)	Rated ripple (Arms)	tan δ	Leakage Current (mA)	Code
10000	35×80	4.9	0.25	2.12	LNT1H103MSE
15000	35×100	5.5	0.25	2.59	LNT1H153MSE
22000	51×80	6.3	0.25	3.14	LNT1H223MSE
33000	51×120	8.0	0.30	3.85	LNT1H333MSE
47000	63.5×100	9.9	0.35	4.59	LNT1H473MSE
68000	63.5×120	12.8	0.35	5.00	LNT1H683MSE
100000	76.2×120	16.8	0.55	5.00	LNT1H104MSE
150000	90×140	19.5	0.75	5.00	LNT1H154MSE
220000	90×170	22.0	0.75	5.00	LNT1H224MSE
330000	90×220	24.3	0.75	5.00	LNT1H334MSE
470000	100×250	26.1	0.75	5.00	LNT1H474MSE

63V (1J)					
Cap. (μF)	Size φD × L(mm)	Rated ripple (Arms)	tan δ	Leakage Current (mA)	Code
10000	35×100	5.0	0.25	2.38	LNT1J103MSE
15000	51×80	5.9	0.25	2.91	LNT1J153MSE
22000	51×100	6.9	0.25	3.53	LNT1J223MSE
33000	63.5×100	9.4	0.30	4.32	LNT1J333MSE
47000	63.5×120	11.2	0.30	5.00	LNT1J473MSE
68000	76.2×120	13.5	0.50	5.00	LNT1J683MSE
100000	90×140	17.8	0.60	5.00	LNT1J104MSE
150000	90×170	21.0	0.60	5.00	LNT1J154MSE
220000	90×220	23.7	0.60	5.00	LNT1J224MSE
330000	100×250	26.1	0.60	5.00	LNT1J334MSE

80V (1K)					
Cap. (μF)	Size φD × L(mm)	Rated ripple (Arms)	tan δ	Leakage Current (mA)	Code
4700	35×80	3.5	0.20	1.83	LNT1K472MSE
6800	35×100	3.9	0.20	2.21	LNT1K682MSE
10000	51×80	5.4	0.20	2.68	LNT1K103MSE
15000	51×100	6.4	0.20	3.28	LNT1K153MSE
22000	63.5×100	8.4	0.25	3.97	LNT1K223MSE
33000	76.2×100	9.9	0.30	4.87	LNT1K333MSE
47000	76.2×120	13.4	0.35	5.00	LNT1K473MSE
68000	90×140	17.0	0.40	5.00	LNT1K683MSE
100000	90×170	18.6	0.40	5.00	LNT1K104MSE
150000	90×220	21.6	0.40	5.00	LNT1K154MSE
220000	100×250	24.8	0.40	5.00	LNT1K224MSE

100V (2A)					
Cap. (μF)	Size φD × L(mm)	Rated ripple (Arms)	tan δ	Leakage Current (mA)	Code
2200	35×80	2.4	0.12	1.40	LNT2A222MSE
3300	35×80	3.3	0.12	1.72	LNT2A332MSE
4700	35×100	3.8	0.12	2.05	LNT2A472MSE
6800	51×80	5.2	0.15	2.47	LNT2A682MSE
10000	51×100	6.7	0.15	3.00	LNT2A103MSE
15000	63.5×100	7.8	0.20	3.67	LNT2A153MSE
22000	76.2×100	9.9	0.30	4.44	LNT2A223MSE
33000	76.2×140	12.7	0.30	5.00	LNT2A333MSE
47000	90×140	17.0	0.30	5.00	LNT2A473MSE
68000	90×170	18.2	0.30	5.00	LNT2A683MSE
100000	90×220	20.6	0.30	5.00	LNT2A104MSE
150000	100×220	23.4	0.30	5.00	LNT2A154MSE

Rated ripple current (Arms) at 105°C 120Hz

**NT** series

■Dimensions

160V (2C)					
Cap. (μF)	Size φD × L(mm)	Rated ripple (Arms)	tan δ	Leakage Current (mA)	Code
1000	35×80	1.6	0.15	1.20	LNT2C102MSE
1500	35×80	2.1	0.15	1.46	LNT2C152MSE
2200	35×100	2.7	0.15	1.77	LNT2C222MSE
3300	51×80	3.8	0.15	2.17	LNT2C332MSE
4700	51×100	4.5	0.15	2.60	LNT2C472MSE
6800	63.5×100	6.8	0.20	3.12	LNT2C682MSE
10000	63.5×120	7.8	0.20	3.79	LNT2C103MSE
15000	76.2×120	9.8	0.20	4.64	LNT2C153MSE
22000	76.2×140	12.5	0.20	5.00	LNT2C223MSE
33000	90×140	13.4	0.25	5.00	LNT2C333MSE
47000	90×220	17.2	0.25	5.00	LNT2C473MSE
68000	100×250	19.2	0.25	5.00	LNT2C683MSE

200V (2D)					
Cap. (μF)	Size φD × L(mm)	Rated ripple (Arms)	tan δ	Leakage Current (mA)	Code
1000	35×80	1.7	0.15	1.34	LNT2D102MSE
1500	35×100	2.3	0.15	1.64	LNT2D152MSE
2200	51×80	2.9	0.15	1.99	LNT2D222MSE
3300	51×100	3.9	0.15	2.43	LNT2D332MSE
4700	63.5×100	5.1	0.20	2.90	LNT2D472MSE
6800	63.5×120	7.0	0.20	3.49	LNT2D682MSE
10000	76.2×120	8.2	0.20	4.24	LNT2D103MSE
15000	76.2×140	10.4	0.20	5.00	LNT2D153MSE
22000	90×140	15.1	0.25	5.00	LNT2D223MSE
33000	90×220	16.6	0.25	5.00	LNT2D333MSE
47000	90×250	19.9	0.25	5.00	LNT2D473MSE

250V (2E)					
Cap. (μF)	Size φD × L(mm)	Rated ripple (Arms)	tan δ	Leakage Current (mA)	Code
680	35×80	1.4	0.15	1.23	LNT2E681MSE
1000	35×100	1.9	0.15	1.50	LNT2E102MSE
1500	51×80	2.4	0.15	1.83	LNT2E152MSE
2200	51×100	3.2	0.15	2.22	LNT2E222MSE
3300	63.5×100	4.3	0.20	2.72	LNT2E332MSE
4700	63.5×120	5.9	0.20	3.25	LNT2E472MSE
6800	76.2×120	7.1	0.20	3.91	LNT2E682MSE
10000	90×140	9.6	0.25	4.74	LNT2E103MSE
15000	90×170	12.7	0.25	5.00	LNT2E153MSE
22000	90×220	15.4	0.25	5.00	LNT2E223MSE
33000	100×250	17.0	0.25	5.00	LNT2E333MSE

350V (2V)					
Cap. (μF)	Size φD × L(mm)	Rated ripple (Arms)	tan δ	Leakage Current (mA)	Code
330	35×80	2.1	0.20	1.01	LNT2V331MSEC
470	35×80	2.8	0.20	1.21	LNT2V471MSEC
680	51×80	4.1	0.20	1.46	LNT2V681MSEF
1000	51×80	6.5	0.20	1.77	LNT2V102MSEF
1500	51×100	8.6	0.20	2.17	LNT2V152MSEF
2200	51×120	11.0	0.20	2.63	LNT2V222MSEF
2700	63.5×100	12.7	0.20	2.91	LNT2V272MSEG
3300	63.5×110	14.4	0.20	3.22	LNT2V332MSEG
3900	63.5×130	16.8	0.20	3.50	LNT2V392MSEG
4700	63.5×150	19.8	0.20	3.84	LNT2V472MSEG
	76.2×120	19.7	0.20	3.84	LNT2V472MSEH
5600	63.5×170	22.7	0.20	4.20	LNT2V562MSEG
	76.2×130	22.2	0.20	4.20	LNT2V562MSEH
6800	76.2×150	26.2	0.20	4.62	LNT2V682MSEH
8200	76.2×170	30.3	0.20	5.00	LNT2V822MSEH
	90×150	29.3	0.20	5.00	LNT2V822MSEJ
10000	90×150	32.4	0.20	5.00	LNT2V103MSEJ
12000	90×190	36.0	0.20	5.00	LNT2V123MSEJ
15000	90×220	42.9	0.20	5.00	LNT2V153MSEJ
22000	100×250	48.0	0.20	5.00	LNT2V223MSEK

Rated ripple current (Arms) at 105°C 120Hz

### ■Dimensions

400V (2G)					
Cap. (μF)	Size φD × L(mm)	Rated ripple (Arms)	tan δ	Leakage Current (mA)	Code
220	35×80	1.6	0.20	0.88	LNT2G221MSEC
330	35×80	2.3	0.20	1.09	LNT2G331MSEC
470	35×100	3.1	0.20	1.30	LNT2G471MSEC
680	51×80	4.2	0.20	1.56	LNT2G681MSEF
1000	51×80	6.6	0.20	1.89	LNT2G102MSEF
1500	51×120	9.1	0.20	2.32	LNT2G152MSEF
2200	63.5×100	11.5	0.20	2.81	LNT2G222MSEG
2700	63.5×110	13.1	0.20	3.11	LNT2G272MSEG
3300	63.5×130	15.4	0.20	3.44	LNT2G332MSEG
3900	63.5×150	17.9	0.20	3.74	LNT2G392MSEG
	76.2×110	18.2	0.20	3.74	LNT2G392MSEH
4700	63.5×170	20.7	0.20	4.11	LNT2G472MSEG
	76.2×130	20.3	0.20	4.11	LNT2G472MSEH
5600	76.2×150	23.7	0.20	4.49	LNT2G562MSEH
6800	76.2×170	27.6	0.20	4.94	LNT2G682MSEH
	90×150	26.9	0.20	4.94	LNT2G682MSEJ
8200	90×170	31.0	0.20	5.00	LNT2G822MSEJ
10000	90×190	32.9	0.20	5.00	LNT2G103MSEJ
12000	90×220	38.3	0.20	5.00	LNT2G123MSEJ
15000	100×220	44.5	0.20	5.00	LNT2G153MSEK

450V (2W)					
Cap. (μF)	Size φD × L(mm)	Rated ripple (Arms)	tan δ	Leakage Current (mA)	Code
220	35×80	1.8	0.20	0.94	LNT2W221MSEC
330	35×100	2.4	0.20	1.15	LNT2W331MSEC
470	51×80	3.4	0.20	1.37	LNT2W471MSEF
680	51×100	4.4	0.20	1.65	LNT2W681MSEF
1000	51×100	7.0	0.20	2.01	LNT2W102MSEF
1500	51×120	9.2	0.20	2.46	LNT2W152MSEF
2200	63.5×110	11.8	0.20	2.98	LNT2W222MSEG
2700	63.5×130	13.8	0.20	3.30	LNT2W272MSEG
	76.2×110	14.5	0.20	3.30	LNT2W272MSEH
3300	63.5×150	16.5	0.20	3.65	LNT2W332MSEG
	76.2×130	17.1	0.20	3.65	LNT2W332MSEH
3900	63.5×170	18.3	0.20	3.97	LNT2W392MSEG
4700	76.2×150	21.7	0.20	4.36	LNT2W472MSEH
5600	76.2×190	26.4	0.20	4.76	LNT2W562MSEH
	90×150	24.1	0.20	4.76	LNT2W562MSEJ
6800	90×170	28.3	0.20	5.00	LNT2W682MSEJ
8200	90×190	32.5	0.20	5.00	LNT2W822MSEJ
10000	90×220	35.1	0.20	5.00	LNT2W103MSEJ
12000	90×230	39.2	0.20	5.00	LNT2W123MSEJ
15000	90×250	45.6	0.20	5.00	LNT2W153MSEJ

500V (2H)					
Cap. (μF)	Size φD × L(mm)	Rated ripple (Arms)	tan δ	Leakage Current (mA)	Code
330	51×80	2.7	0.20	1.21	LNT2H331MSEF
470	51×80	3.2	0.20	1.45	LNT2H471MSEF
680	51×100	4.2	0.20	1.74	LNT2H681MSEF
1000	51×120	5.5	0.20	2.12	LNT2H102MSEF
1500	63.5×110	7.1	0.20	2.59	LNT2H152MSEG
2200	63.5×130	9.3	0.20	3.14	LNT2H222MSEG
2700	63.5×150	11.0	0.20	3.48	LNT2H272MSEG
	76.2×130	11.0	0.20	3.48	LNT2H272MSEH
3300	63.5×170	12.9	0.20	3.85	LNT2H332MSEG
	76.2×150	13.0	0.20	3.85	LNT2H332MSEH
3900	76.2×150	14.1	0.20	4.18	LNT2H392MSEH
4700	76.2×190	17.2	0.20	4.59	LNT2H472MSEH
	90×150	16.3	0.20	4.59	LNT2H472MSEJ
5600	90×150	17.8	0.20	5.00	LNT2H562MSEJ
6800	90×170	20.7	0.20	5.00	LNT2H682MSEJ
8200	90×220	25.5	0.20	5.00	LNT2H822MSEJ
10000	90×250	29.9	0.20	5.00	LNT2H103MSEJ

Rated ripple current (Arms) at 105°C 120Hz

### ● Frequency coefficient of rated ripple current

Coeff.	Frequency (Hz)					
	10 to 100V	60	120	360	1k	10k or more
	160 to 250V	0.90	1.00	1.08	1.15	1.15
	350 to 500V	0.88	1.00	1.08	1.15	1.20
		0.82	1.00	1.20	1.35	1.40