

TLP559

GaAs IRED & PHOTO-IC

(TLP559)

DIGITAL LOGIC GROUND ISOLATION

LINE RECEIVER

MICROPROCESSOR SYSTEM INTERFACES

SWITCHING POWER SUPPLY FEEDBACK CONTROL

TRANSISTOR INVERTOR

The TOSHIBA TLP559 consists of a GaAs high-output light emitting diode and a high speed detector of one chip photo diode-transistor. This unit is 8-lead DIP package.

TLP559 has no internal base connection, and a Faraday shield integrated on the photodetector chip provides an effective common mode noise transient immunity.

So this is suitable for application in noisy environmental condition.

- Isolation Voltage : 2500Vrms (Min.)
- Switching Speed : $t_{pHL} = 0.3\mu s$ (Typ.)
 $t_{pLH} = 0.5\mu s$ (Typ.) ($R_L = 1.9k\Omega$)
- TTL Compatible
- UL Recognized : UL1577, File No. E67349

Unit in mm

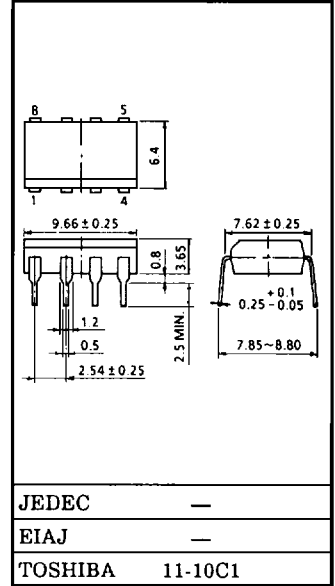

Weight : 0.54g

PIN CONFIGURATION (TOP VIEW)

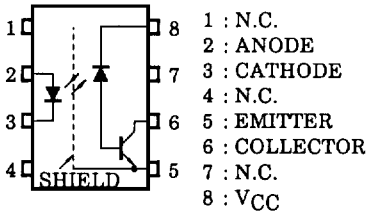

SCHEMATIC

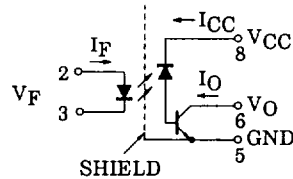

(TLP559)

MAXIMUM RATINGS (Ta = 25°C)

CHARACTERISTIC		SYMBOL	RATING	UNIT
LED	Forward Current (Note 1)	I _F	25	mA
	Pulse Forward Current (Note 2)	I _{FP}	50	mA
	Peak Transient Forward Current (Note 3)	I _{FPT}	1	A
	Reverse Voltage	V _R	5	V
	Diode Power Dissipation (Note 4)	P _D	45	mW
DETECTOR	Output Current	I _O	8	mA
	Peak Output Current	I _{OP}	16	mA
	Output Voltage	V _O	-0.5~15	V
	Supply Voltage	V _{CC}	-0.5~15	V
	Output Power Dissipation (Note 5)	P _O	100	mW
Operating Temperature Range		T _{opr}	-55~100	°C
Storage Temperature Range		T _{stg}	-55~125	°C
Lead Solder Temperature (10sec.) (Note 6)		T _{sold}	260	°C
Isolation Voltage (AC, 1 min., RH ≤ 60%) (Note 7)		BV _S	2500	V _{rms}

Note 1 : Derate 0.8mA above 70°C.

Note 2 : 50% duty cycle, 1ms pulse width.
Derate 1.6mA/°C above 70°C.

Note 3 : Pulse width ≤ 1μs, 300pps.

Note 4 : Derate 0.9mW/°C above 70°C.

Note 5 : Derate 2mW/°C above 70°C.

Note 6 : Soldering portion of lead : up to 2mm from body of the devise.

Note 7 : Device considered a two-terminal device : Pins 1, 2, 3, and 4 shorted together and pins 5, 6, 7, and 8 shorted together.

(TLP559)

ELECTRICAL CHARACTERISTICS (Ta = 25°C)

CHARACTERISTIC		SYMBOL	TEST CONDITION	MIN.	TYP.	MAX.	UNIT
LED	Forward Voltage	V_F	$I_F = 16\text{mA}$	—	1.65	1.85	V
	Forward Voltage Temperature Coefficient	$\Delta V_F / \Delta T_a$	$I_F = 16\text{mA}$	—	-2	—	mV/°C
	Reverse Current	I_R	$V_R = 5\text{V}$	—	—	10	μA
	Capacitance Between Terminal	C_T	$V_F = 0, f = 1\text{MHz}$	—	45	—	pF
DETECTOR	High Level Output Current	$I_{OH(1)}$	$I_F = 0\text{mA}, V_{CC} = V_O = 5.5\text{V}$	—	3	500	nA
		$I_{OH(2)}$	$I_F = 0\text{mA}, V_{CC} = V_O = 15\text{V}$	—	—	5	μA
		I_{OH}	$I_F = 0\text{mA}, V_{CC} = 15\text{V}$ $V_O = 15\text{V}, T_a = 70^\circ\text{C}$	—	—	50	μA
	High Level Supply Voltage	I_{CCH}	$I_F = 0\text{mA}, V_{CC} = 15\text{V}$	—	0.01	1	μA
COUPLED	Current Transfer Ratio	I_O / I_F	$I_F = 16\text{mA}, V_{CC} = 4.5\text{V}$ $V_O = 0.4\text{V}$	20	40	—	%
	Low Level Output Voltage	V_{OL}	$I_F = 16\text{mA}, V_{CC} = 4.5\text{V}$ $I_O = 2.4\text{mA}$	—	—	0.4	V
	Resistance (Input-Output)	R_S	R.H. $\leq 60\%, V_S = 500\text{V}_{DC}$ (Note 7)	5×10^{10}	10^{12}	—	Ω
	Capacitance (Input-Output)	C_S	$V_S = 0, f = 1\text{MHz}$ (Note 7)	—	0.8	—	pF

SWITCHING CHARACTERISTICS (Ta = 25°C, VCC = 5V)

CHARACTERISTIC	SYMBOL	TEST CIRCUIT	TEST CONDITION	MIN.	TYP.	MAX.	UNIT
Propagation Delay Time (H→L)	t_{pHL}	1	$I_F = 16\text{mA}, R_L = 1.9\text{k}\Omega$	—	0.2	0.8	μs
Propagation Delay Time (L→H)	t_{pLH}			—	0.3	0.8	μs
Common Mode Transient Immunity at Logic High Output (Note 8)	CM_H	2	$I_F = 0\text{mA}, V_{CM} = 400\text{V}_p-p$ $R_L = 4.1\text{k}\Omega$	2000	10000	—	V/ μs
Common Mode Transient Immunity at Logic High Output (Note 8)	CM_L		$I_F = 16\text{mA}, V_{CM} = 400\text{V}_p-p$ $R_L = 4.1\text{k}\Omega$	-2000	-10000	—	V/ μs

Note 8 : CM_L is the maximum rate of fall of the common mode voltage that can be sustained with the output voltage in the logic low state ($V_O < 0.8\text{V}$).

CM_H is the maximum rate of rise of the common mode voltage that can be sustained with the output voltage in the logic high state ($V_O < 2.0\text{V}$).

Note 9 : Maximum electrostatic discharge voltage for any pins : 100V (C=200pF, R=0)

(TLP559)

TEST CIRCUIT 1 : Switching Time Test Circuit

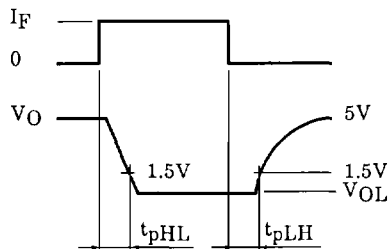
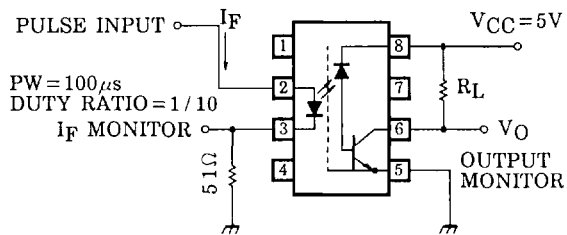

TEST CIRCUIT 2 : Common Mode Noise Immunity Test Circuit

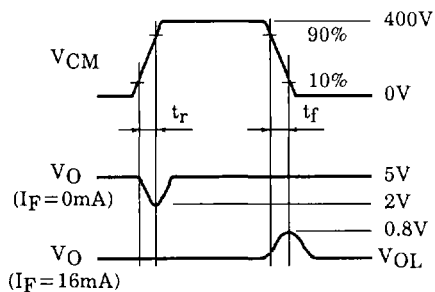
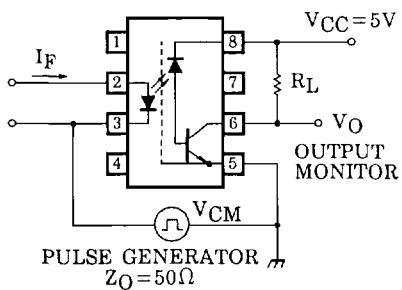

$$CM_H = \frac{320 (V)}{t_r (\mu s)}, \quad CM_L = \frac{320 (V)}{t_f (\mu s)}$$

(TLP559)

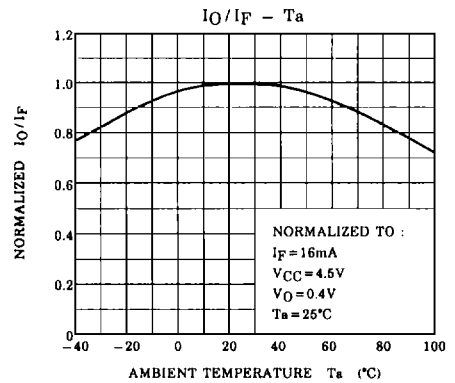
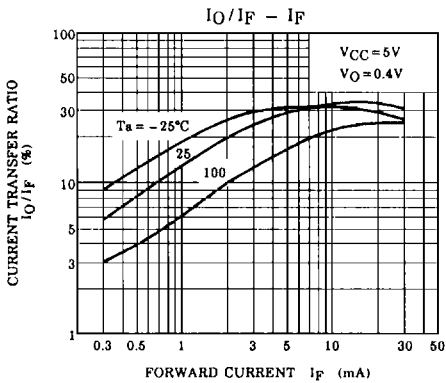
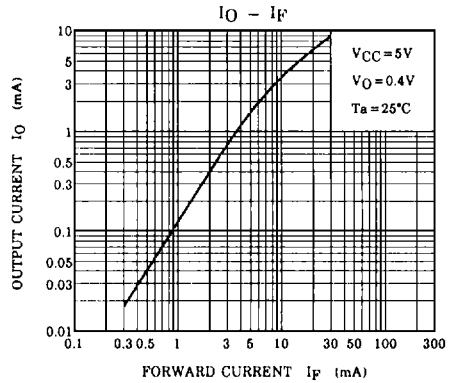
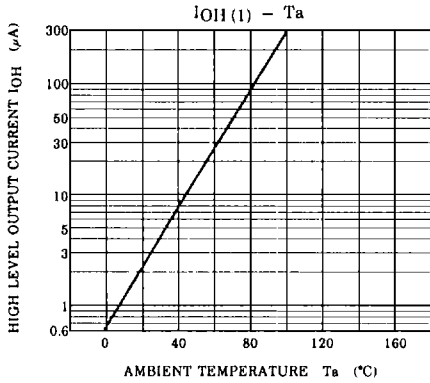
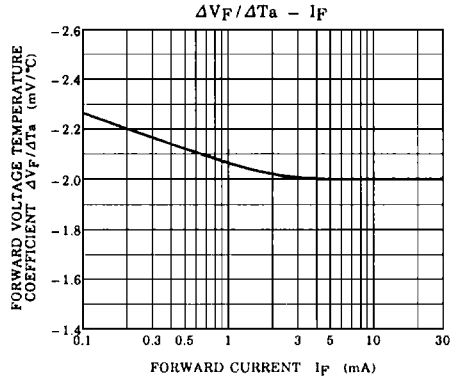
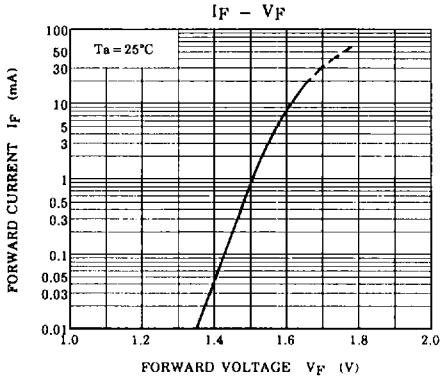

(TLP559)

