

PACKAGE TYPES

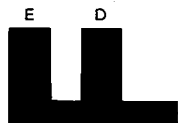

TYPE 6



TYPE 8

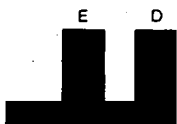

TYPE 7

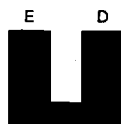

TYPE 9 C1996

DESCRIPTION

The MSTXXX series of optoswitches is designed to allow the user maximum flexibility in his application. Each switch consists of an infra-red emitting diode facing an NPN silicon photo-transistor across a 0.125" (3.18 mm) gap. Switching occurs whenever an IR-opaque object passes through the slot. A polysulfone housing provides excellent chemical and solvent resistance while allowing a fully enclosed design that keeps out dust and dirt.

FEATURES

- Full enclosed design
- Choice of 4 mounting configurations
- Choice of 3 detector apertures
- Choice of 3 CTR_(SAT) levels
- Choice of 2 lead spacing
- Superior polysulfone material

ABSOLUTE MAXIMUM RATINGS

Storage temperature range -55°C to 100°C
Operating temperature range -55°C to 100°C
Lead temperature (soldering 5 sec.) 260°C
INPUT DIODE	
Power dissipation 100 mW
Derate linearly 1.33 mW/°C above 25°C ambient	
Continuous forward current 50 mA
Peak forward current (1μsec PW, 300 pps) 1 A

OUTPUT TRANSISTOR	
Power dissipation 150 mW
Derate linearly 2 mW/°C above 25°C ambient	
Continuous collector current 100 mA
Collector-emitter voltage 30 V
Emitter-collector voltage 5 V

MST6XXX MST7XXX MST8XXX MST9XXX

ELECTRICAL CHARACTERISTICS ($T_A = 25^\circ\text{C}$ Unless Otherwise Specified)

PARAMETER	SYMBOL	MIN.	TYP.	MAX.	UNITS	TEST CONDITIONS
INPUT DIODE						
Forward voltage	V_F		1.5	1.7	V	$I_F = 20\text{ mA}$
Reverse breakdown	BV_R	3.0	15		V	$I_R = 10\mu\text{A}$
Reverse leakage current	I_R			10	μA	$V_R = 3.0\text{ V}$
OUTPUT TRANSISTOR						
Breakdown voltage Collector-emitter	BV_{CE0}	30			V	$I_C = 1\text{ mA}, I_F = 0$
Emitter-collector	BV_{ECO}	5	7		V	$I_E = 100\mu\text{A}, I_F = 0$
Collector dark current	I_{CE0}		5	100	nA	$V_{CE} = 10\text{ V}, I_F = 0, E_b = 0$

TRANSFER CHARACTERISTICS

DC CHARACTERISTICS	SYMBOL	MIN.	TYP.	MAX.	UNITS	TEST CONDITIONS
SATURATED COUPLING						
On-State collector current	$I_{C(ON)}$					
MSTXXX0		0.5			mA	$I_F = 20\text{ mA}, V_{CE} = 0.4\text{ V}$
MSTXXX1		1.0			mA	$I_F = 10\text{ mA}, V_{CE} = 0.4\text{ V}$
MSTXXX2		2.0			mA	$I_F = 20\text{ mA}, V_{CE} = 0.4\text{ V}$

MSTXXX OPTOSWITCH SELECTION CHART

LEAD SPACING	APERTURE	I_F (mA)	I_C (mA) $V_{CE} = 0.4\text{ V}$	PACKAGE 6	PACKAGE 7	PACKAGE 8	PACKAGE 9
.300"	.010"	20	0.5	MST6130	MST7130	MST8130	MST9130
	.020"	20	0.5	MST6230	MST7230	MST8230	MST9230
	.020"	10	1	MST6231	MST7231	MST8231	MST9231
	.020"	20	2	MST6232	MST7232	MST8232	MST9232
	.050"	20	0.5	MST6530	MST7530	MST8530	MST9530
	.050"	10	1	MST6531	MST7531	MST8531	MST9531
.220"	.050"	20	2	MST6532	MST7532	MST8532	MST9532
	.010"	20	0.5	MST6120	MST7120	MST8120	MST9120
	.020"	20	0.5	MST6220	MST7220	MST8220	MST9220
	.020"	10	1	MST6221	MST7221	MST8221	MST9221
	.020"	20	2	MST6222	MST7222	MST8222	MST9222
	.050"	20	0.5	MST6520	MST7520	MST8520	MST9520
.050"	10	1	MST6521	MST7521	MST8521	MST9521	
.050"	20	2	MST6522	MST7522	MST8522	MST9522	

MST6XXX MST7XXX MST8XXX MST9XXX

TYPICAL CHARACTERISTIC CURVES ($T_A = 25^\circ$ Unless Otherwise Specified)

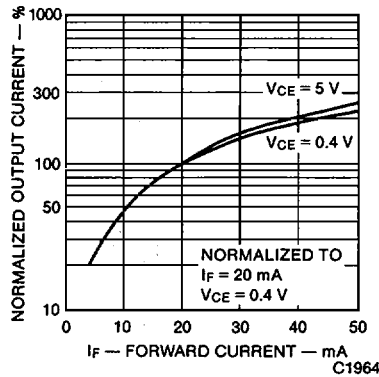

Fig. 1. Normalized Output Current vs. Input Current

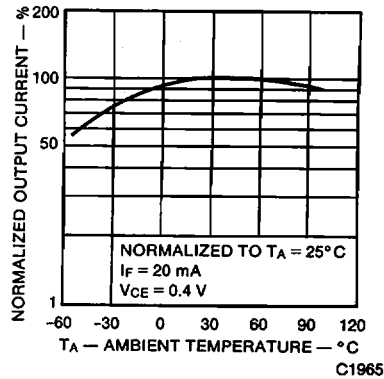

Fig. 2. Normalized Output Current vs. Ambient Temperature

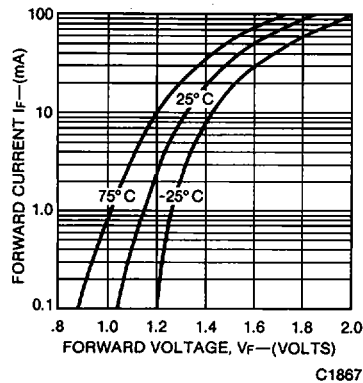

Fig. 3. Forward Current vs. Forward Voltage

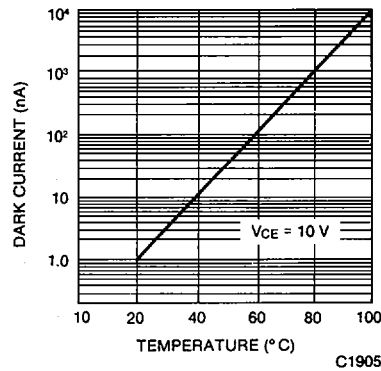

Fig. 4. Collector Dark Current vs. Ambient Temperature

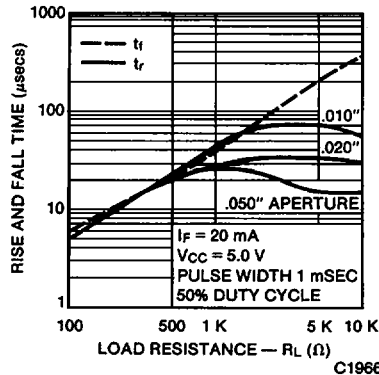

Fig. 5. Rise and Fall Time vs. Load Resistance

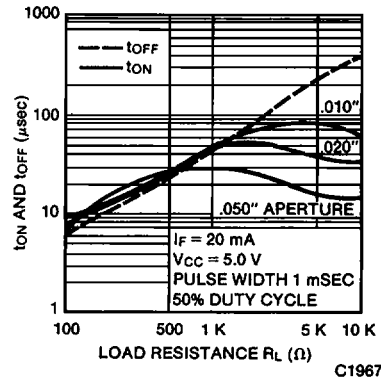

Fig. 6. Turn-on and Turn-off Time vs. Load Resistance

MST6XXX MST7XXX MST8XXX MST9XXX

TYPICAL CHARACTERISTIC CURVES ($T_A = 25^\circ$ Unless Otherwise Specified) (Cont'd)

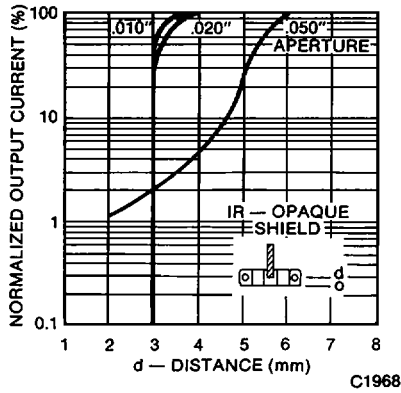

Fig. 7. Normalized Output Current vs. Lateral Shield Displacement

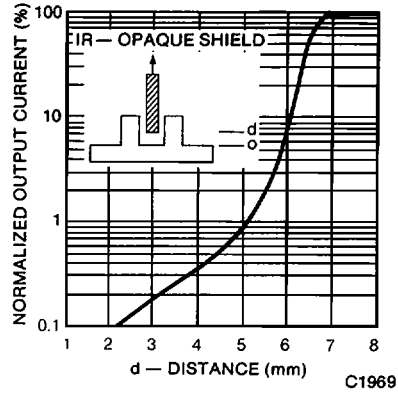

Fig. 8. Normalized Output Current vs. Vertical Shield Displacement

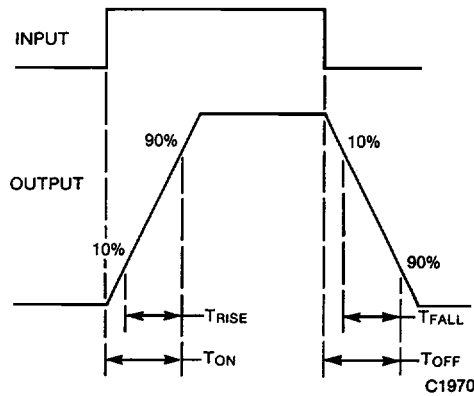
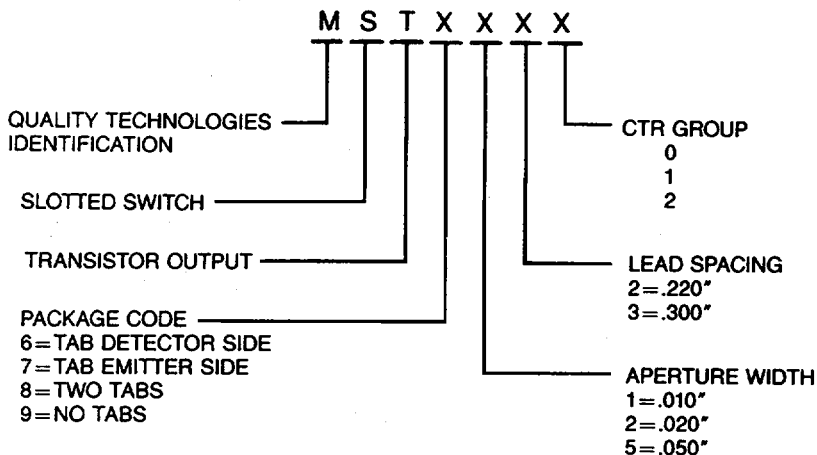

Fig. 9. Definition of Switching Parameters

MST6XXX MST7XXX MST8XXX MST9XXX

MSTXXX SERIES NUMBERING SYSTEM



CROSS-REFERENCE TO TRW AND GE OPTOSWITCHES

CROSS-REFERENCE GUIDE TO TRW OPTOSWITCHES

OPB813	MST8520	OPB860L55	MST7530	OPB865P51	MST6120
OPB813S10	MST8120	OPB860N55	MST9530	OPB865T51	MST8120
OPB814	MST8521	OPB860P55	MST6530	OPB865L55	MST7520
OPB815	MST8522	OPB860T55	MST8530	OPB865N55	MST9520
OPB816	MST8520	OPB861L55	MST7531	OPB865P55	MST6520
OPB817	MST8521	OPB861N55	MST9531	OPB865T55	MST8520
OPB819S10	MST8120	OPB861P55	MST6531	OPB866L55	MST7521
OPB825	MST9530	OPB861T55	MST8531	OPB866N55	MST9521
OPB825A	MST6530	OPB862L55	MST7532	OPB866P55	MST6521
OPB825B	MST8530	OPB862N55	MST9532	OPB866T55	MST8521
OPB860L51	MST7130	OPB862P55	MST6532	OPB867L55	MST7522
OPB860N51	MST9130	OPB861T55	MST8532	OPB867N55	MST9522
OPB860P51	MST6130	OPB865L51	MST7120	OPB867P55	MST6522
OPB860T51	MST8130	OPB865N51	MST9120	OPB867T55	MST8522

CROSS-REFERENCE GUIDE TO GE OPTOSWITCHES

H21A1	MST8532	H21A5*	MST8532	H22A4*	MST9532
H21A2	MST8532	HSSA1	MST9532	H22A5*	MST9532
H21A4*	MST8532	H22A2	MST9532		

*Can be readily selected to guarantee BV_{CEO}.

MST6XXX MST7XXX MST8XXX MST9XXX

PACKAGE DIMENSIONS

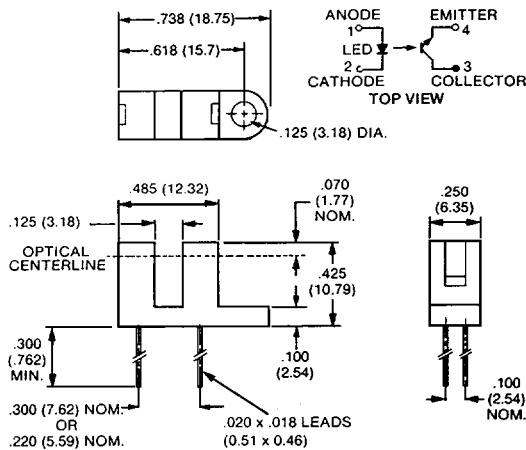

ALL DIMENSIONS ARE IN INCHES (mm)
DIMENSIONS ±.010 INCHES
PIN 1 INDICATED BY DOT ON PACKAGE

Package 6 Dimensions

C1989

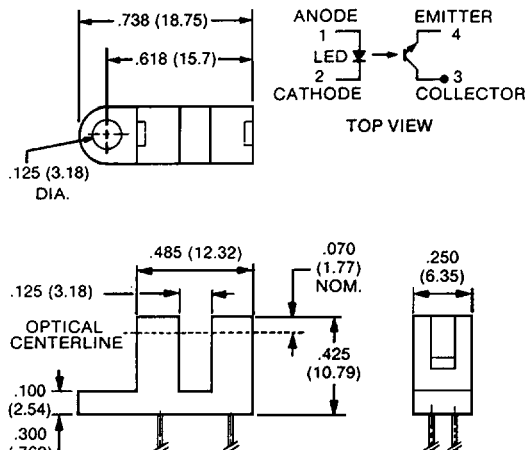

ALL DIMENSIONS ARE IN INCHES (mm)
DIMENSIONS ±.010 INCHES

Package 7 Dimensions

C1988

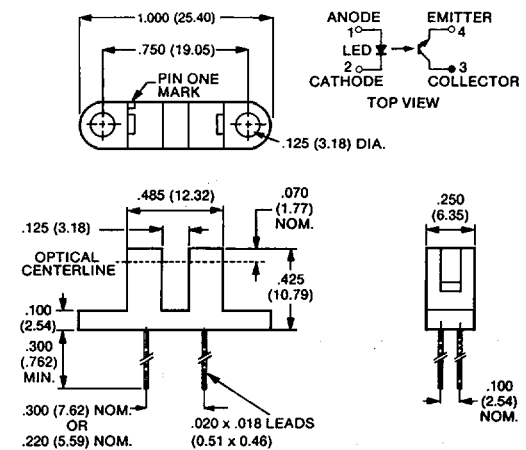

ALL DIMENSIONS ARE IN INCHES (mm)
DIMENSIONS ±.010 INCHES
PIN 1 INDICATED BY DOT ON PACKAGE

Package 8 Dimensions

C1991

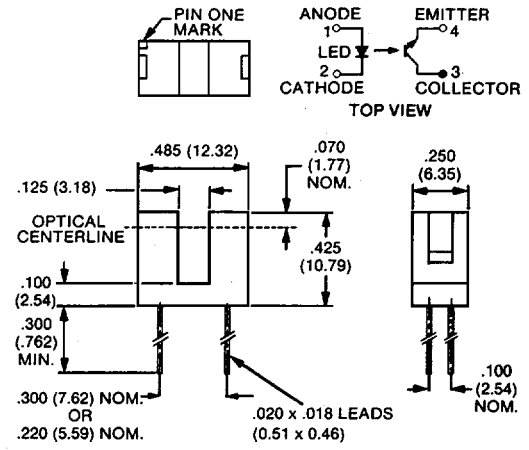

ALL DIMENSIONS ARE IN INCHES (mm)
DIMENSIONS ±.010 INCHES

Package 9 Dimensions

C1990

MST6XXX MST7XXX MST8XXX MST9XXX