

LOW DROPOUT VOLTAGE REGULATOR

■ GENERAL DESCRIPTION

The NJM2856 is a low dropout voltage regulator with ON/OFF control.

Advanced Bipolar technology achieves low noise, high ripple rejection.

It delivers up to 5V/1A output power with the maximum input voltage of 10V.

The NJM2856 is suitable for various applications such as portable / consumer equipments.

■ PACKAGE OUTLINE

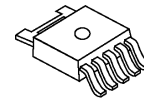

NJM2856DL3

■ FEATURES

- High Ripple Rejection 75dB typ. (f=1kHz,Vo=3V Version)
- Output Noise Voltage Vno=45μVrms typ.
- Output capacitor with 2.2μF ceramic capacitor (Vo≥2.7V)
- Output Current Io(max.)=1A
- High Precision Output Vo±1.0%
- Low Dropout Voltage 0.20V typ. (Io=600mA)
- ON/OFF Control
- Internal Short Circuit Current Limit
- Internal Thermal Overload Protection
- Bipolar Technology
- Package Outline TO-252-5

■ PIN CONFIGURATION

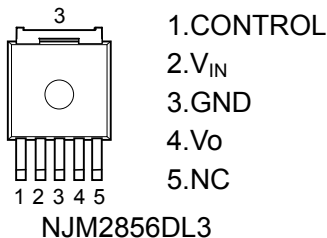

■ EQUIVALENT CIRCUIT

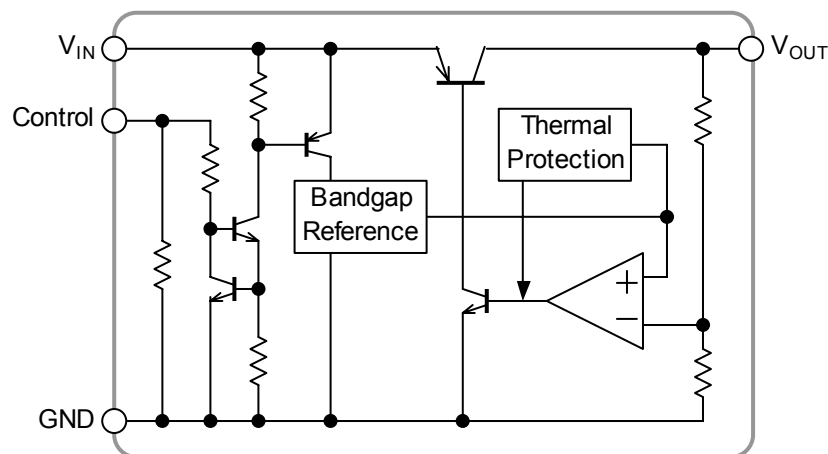

■ OUTPUT VOLTAGE RANK LIST

The WHITE column shows applicable Voltage Rank(s)

Device Name	V _{out}	Device Name	V _{out}
NJM2856DL3-15	1.5V	NJM2856DL3-35	3.5V
NJM2856DL3-16	1.6V	NJM2856DL3-36	3.6V
NJM2856DL3-17	1.7V	NJM2856DL3-37	3.7V
NJM2856DL3-18	1.8V	NJM2856DL3-38	3.8V
NJM2856DL3-19	1.9V	NJM2856DL3-39	3.9V
NJM2856DL3-02	2.0V	NJM2856DL3-04	4.0V
NJM2856DL3-21	2.1V	NJM2856DL3-41	4.1V
NJM2856DL3-22	2.2V	NJM2856DL3-42	4.2V
NJM2856DL3-23	2.3V	NJM2856DL3-43	4.3V
NJM2856DL3-24	2.4V	NJM2856DL3-44	4.4V
NJM2856DL3-25	2.5V	NJM2856DL3-45	4.5V
NJM2856DL3-26	2.6V	NJM2856DL3-46	4.6V
NJM2856DL3-27	2.7V	NJM2856DL3-47	4.7V
NJM2856DL3-28	2.8V	NJM2856DL3-48	4.8V
NJM2856DL3-29	2.9V	NJM2856DL3-49	4.9V
NJM2856DL3-03	3.0V	NJM2856DL3-05	5.0V
NJM2856DL3-31	3.1V		
NJM2856DL3-32	3.2V		
NJM2856DL3-33	3.3V		
NJM2856DL3-34	3.4V		

■ ABSOLUTE MAXIMUM RATINGS (Ta=25°C)

PARAMETER	SYMBOL	RATINGS	UNIT
Input Voltage	V _{IN}	+10	V
Control Voltage	V _{CONT}	+10	V
Power Dissipation	P _D	1190(*1)	mW
Operating Temperature	T _{opr}	-40 ~ +85	°C
Storage Temperature	T _{stg}	-40 ~ +150	°C

(*1): Mounted on glass epoxy board. (114.3x76.2x1.6mm: 2Layers, FR-4, copper area 100mm²)

■ OPERATING VOLTAGE

V_{IN}=+2.5V ~ +8V (In case of Vo<2.3V version)

■ ELECTRICAL CHARACTERISTICS

(V_{IN}=Vo+1V, C_{IN}=0.33μF, Co=2.2μF(1.7V<Vo≤2.6V:4.7μF, Vo≤1.7V:10μF), Ta=25°C)

PARAMETER	SYMBOL	TEST CONDITION	MIN.	TYP.	MAX.	UNIT
Output Voltage	Vo	Io=30mA	-1.0%	-	+1.0%	V
Input Voltage	V _{IN}		-	-	8	V
Quiescent Current	I _Q	Io=0mA	-	400	600	μA
Quiescent Current at Control OFF	I _{Q(OFF)}	V _{CONT} =0V	-	-	100	nA
Output Current	Io	Vo-0.3V	1000	1300	-	mA
Line Regulation	ΔVo/ΔV _{IN}	V _{IN} =Vo+1V~Vo+6V(Vo≤2V), V _{IN} =Vo+1V~8V(Vo>2V), Io=30mA	-	-	0.10	%/V
Load Regulation	ΔVo/ΔIo	Io=0 ~ 1A	-	-	0.004	%/mA
Dropout Voltage(*2)	ΔV _{I-O}	Io=600mA	-	0.20	0.28	V
Ripple Rejection	RR	e _{in} =200mVrms, f=1kHz, Io=10mA Vo=3.0V Version	-	75	-	dB
Average Temperature Coefficient of Output Voltage	ΔVo/ΔTa	Ta=0~85°C, Io=10mA	-	±50	-	ppm/°C
Output Noise Voltage	V _{NO}	f=10Hz~80kHz, Io=10mA, Vo=3.0V Version(*3)	-	45	-	μVrms
Control Current	I _{CONT}	V _{CONT} =1.6V, Io=0mA	-	3	12	μA
Control Voltage for ON-state	V _{CONT(ON)}		1.6	-	-	V
Control Voltage for OFF-state	V _{CONT(OFF)}		-	-	0.6	V
Input Voltage	V _{IN}		-	-	8	V

(*2): The output voltage excludes under 2.1V.

(*3): Vo>2.0V : V_{IN}=Vo+1V, Vo≤2.0V : V_{IN}=3.0V

The above specification is a common specification for all output voltages.

Therefore, it may be different from the individual specification for a specific output voltage.

■ POWER DISSIPATION vs. AMBIENT TEMPERATURE

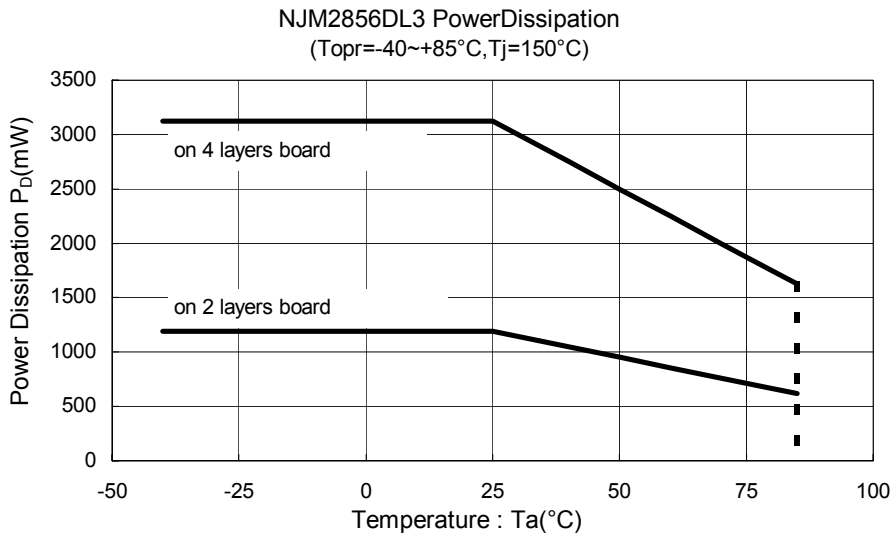

■ TEST CIRCUIT

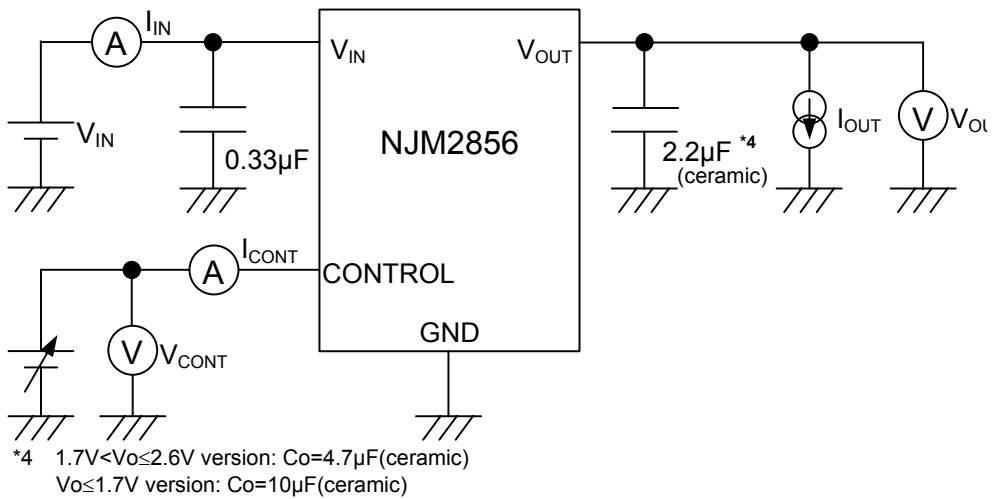

■ TYPICAL APPLICATION

① In the case where ON/OFF Control is not required:

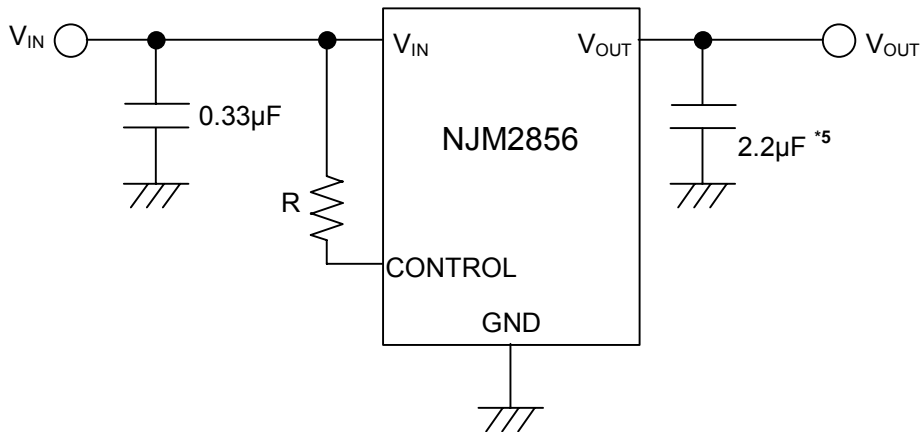

*5 1.7V $V_o \le 2.6V$ version: $C_o = 4.7\mu F$
 $V_o \le 1.7V$ version: $10\mu F$

Connect control terminal to V_{IN} terminal

② In use of ON/OFF CONTROL:

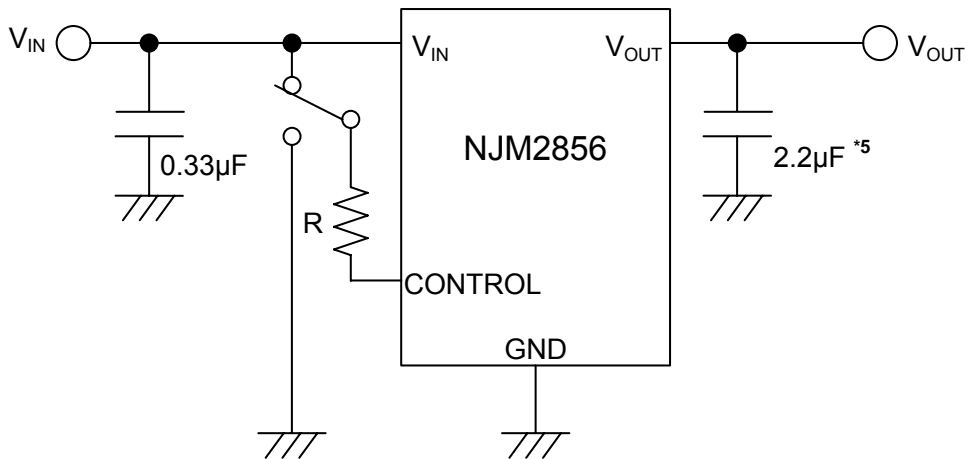

*5 1.7V $V_o \le 2.6V$ version: $C_o = 4.7\mu F$
 $V_o \le 1.7V$ version: $10\mu F$

State of control terminal:

- "H" → output is enabled.
- "L" or "open" → output is disabled.

*In the case of using a resistance "R" between V_{IN} and control.

The current flow into the control terminal while the IC is ON state (I_{CONT}) can be reduced when a pull up resistance "R" is inserted between V_{IN} and the control terminal.

The minimum control voltage for ON state ($V_{CONT(ON)}$) is increased due to the voltage drop caused by I_{CONT} and the resistance "R".

***Input Capacitance C_{IN}**

Input Capacitance C_{IN} is required to prevent oscillation and reduce power supply ripple for applications with high power supply impedance or a long power supply line.

Use the C_{IN} value of $0.33\mu\text{F}$ greater to avoid the problem.

C_{IN} should connect between GND and V_{IN} as short as possible.

***Output Capacitance C_o**

Output capacitor (C_o) is required for a phase compensation of the internal error amplifier. The capacitance and the equivalent series resistance (ESR) influence stability of the regulator.

If use a smaller C_o , it may cause excess output noise or oscillation of the regulator due to lack of the phase compensation. Therefore, use C_o with the recommended capacitance or greater value and connect between V_o terminal and GND terminal with minimal wiring.

The recommended capacitance depends on the output voltage. Low voltage regulator requires greater value of the C_o . Thus, check the recommended capacitance for each output voltage.

Use of a greater C_o reduces output noise and ripple output, and also improves transient response of the output voltage against rapid load change.

This product is designed to work with any capacitor including a low ESR capacitor for the C_o ; however, refer "Equivalent Series Resistance vs. Output Current" and choose suitable capacitor.

■ TYPICAL CHARACTERISTICS

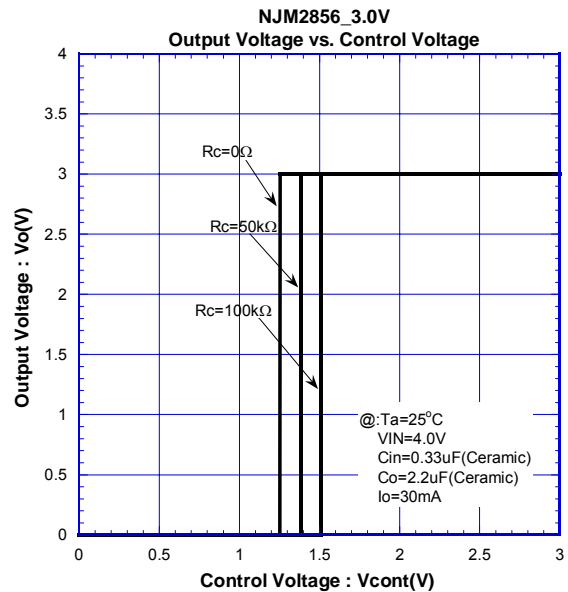
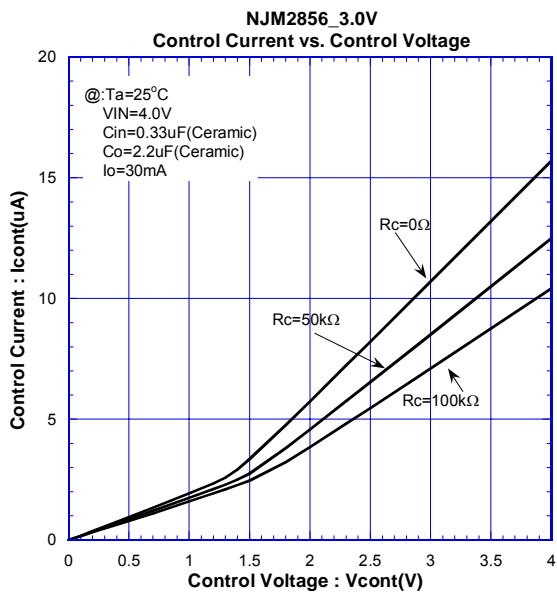
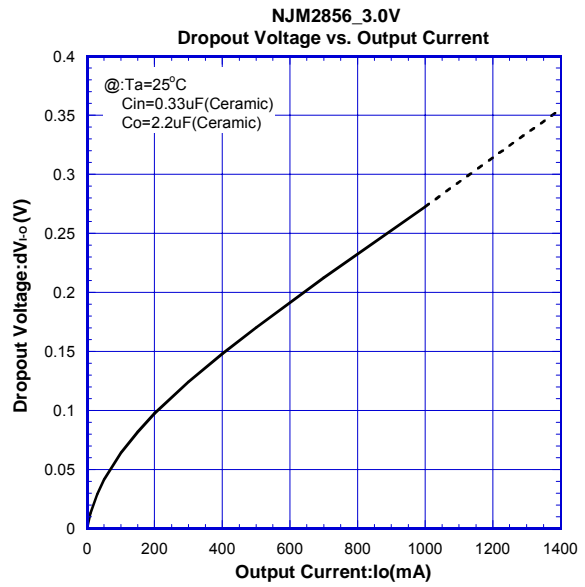
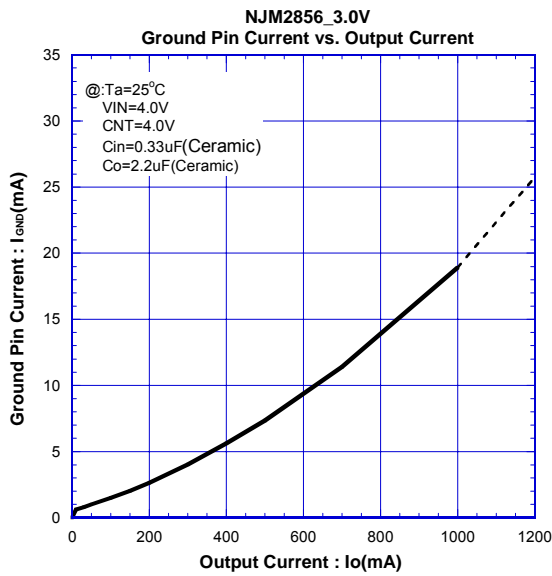
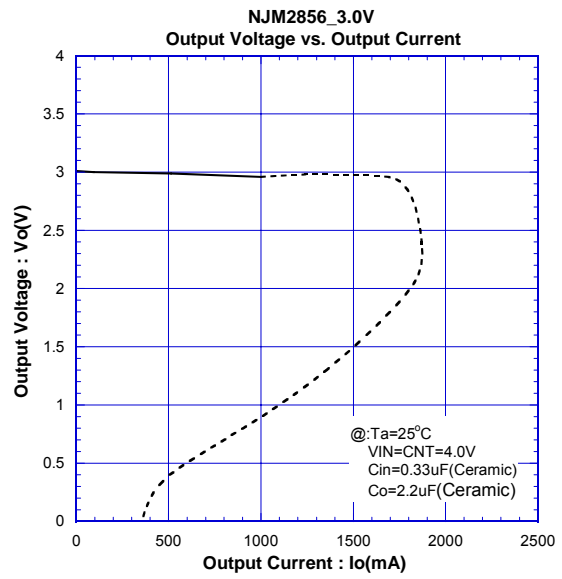
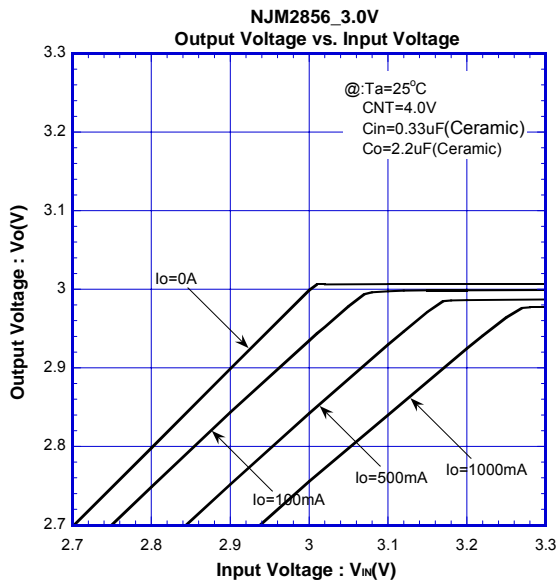

TYPICAL CHARACTERISTICS

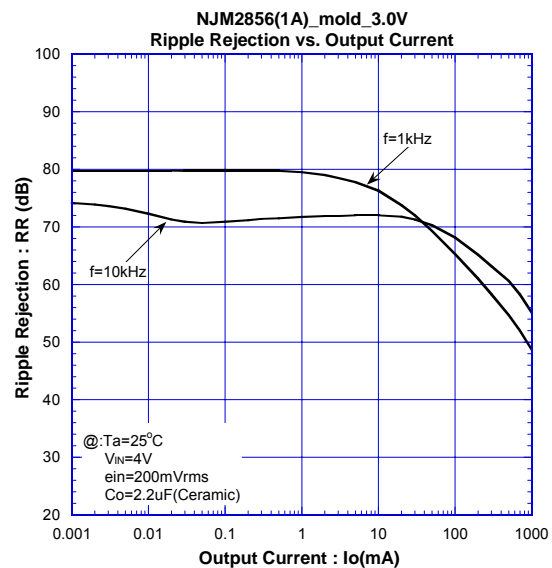
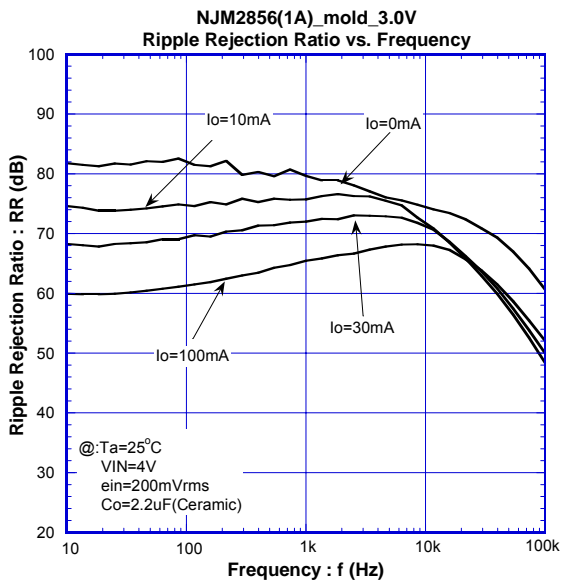
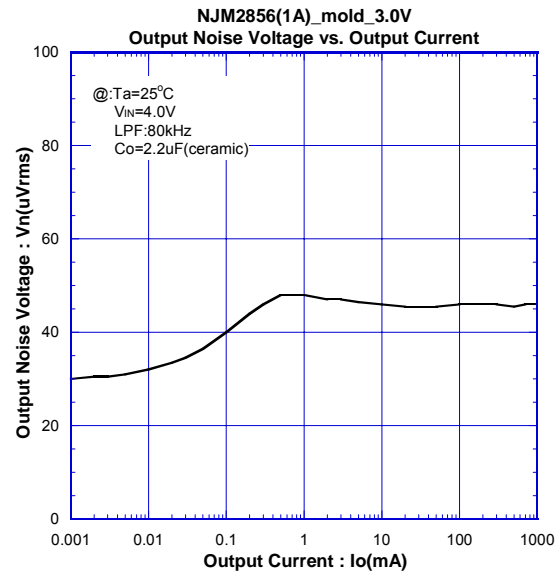
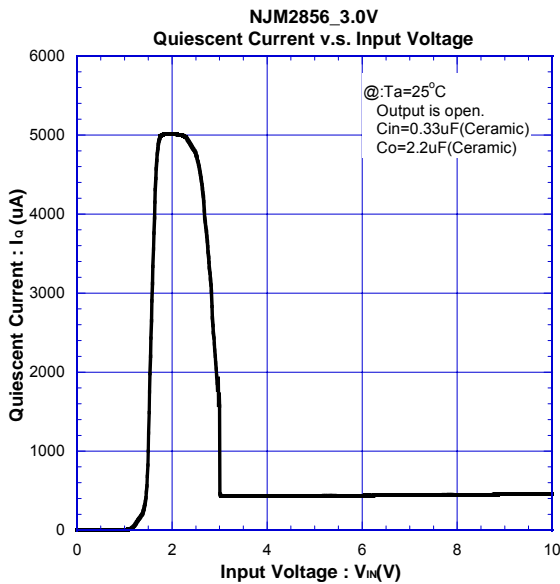
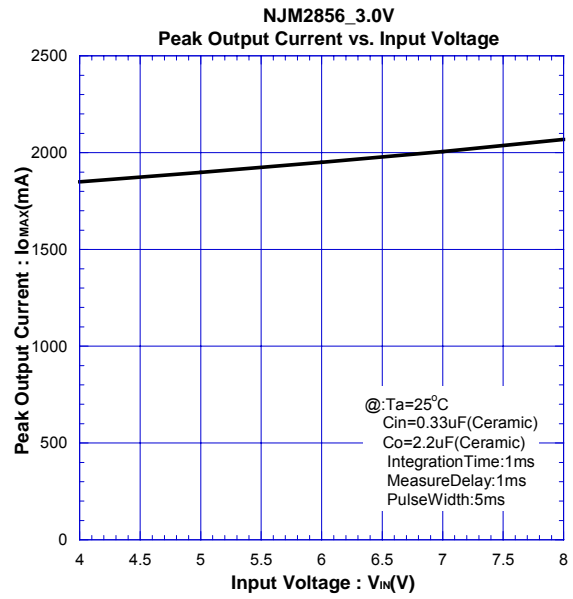
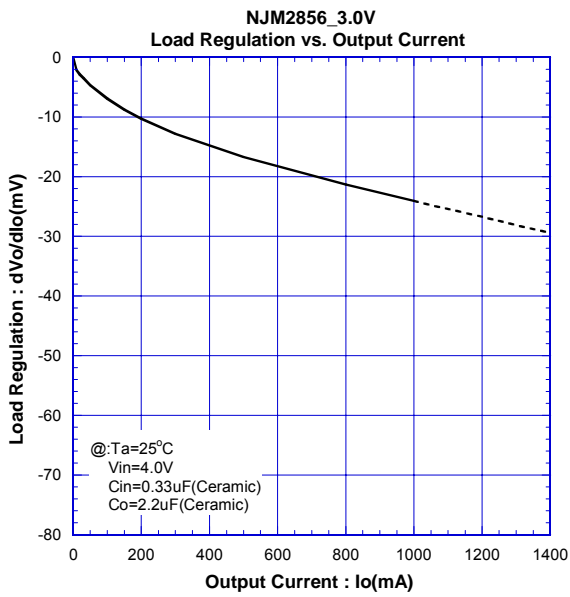

TYPICAL CHARACTERISTICS

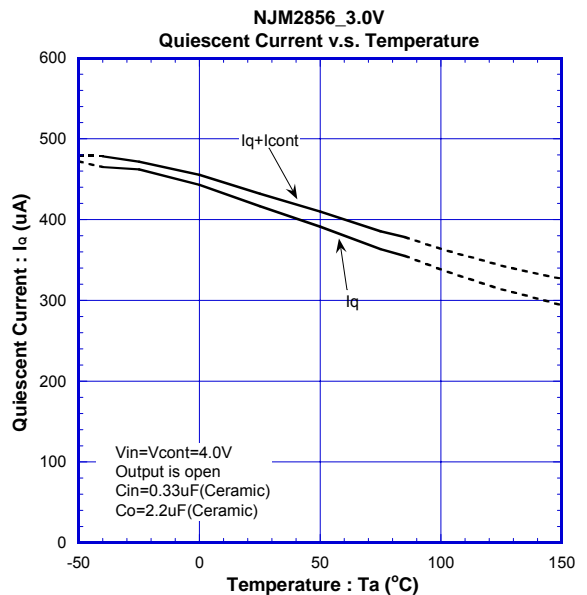
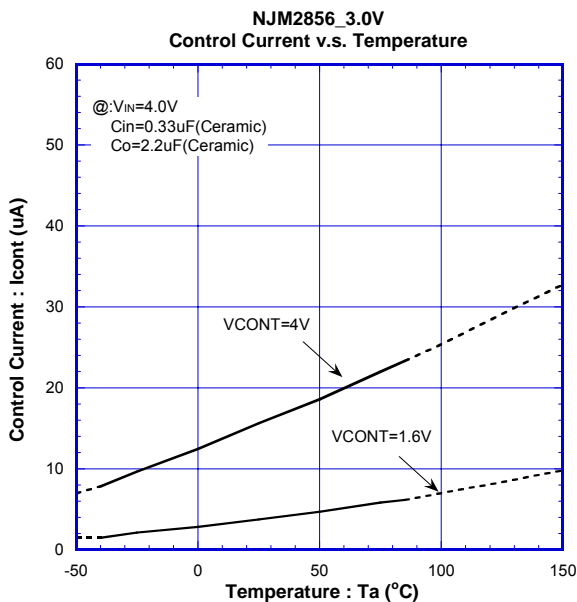
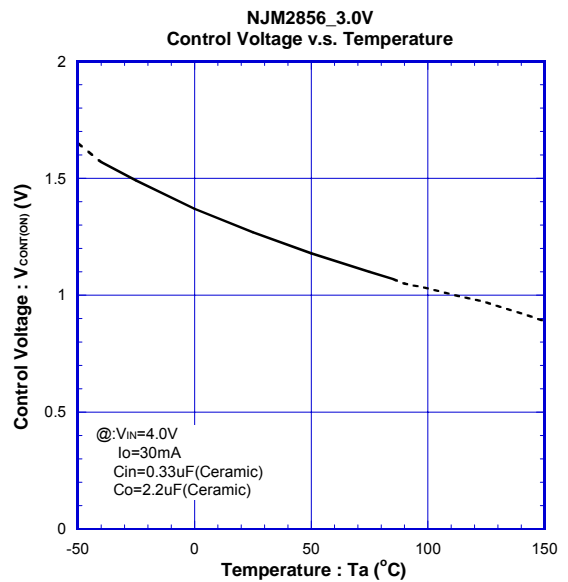
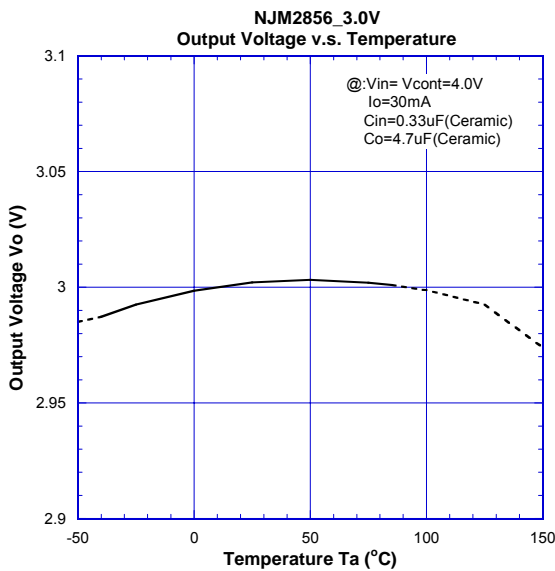
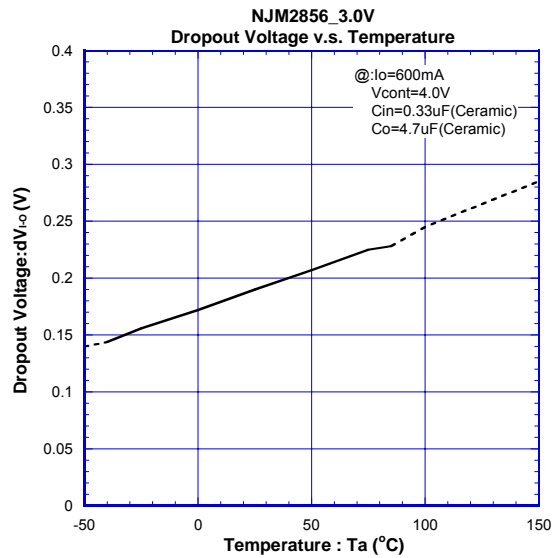
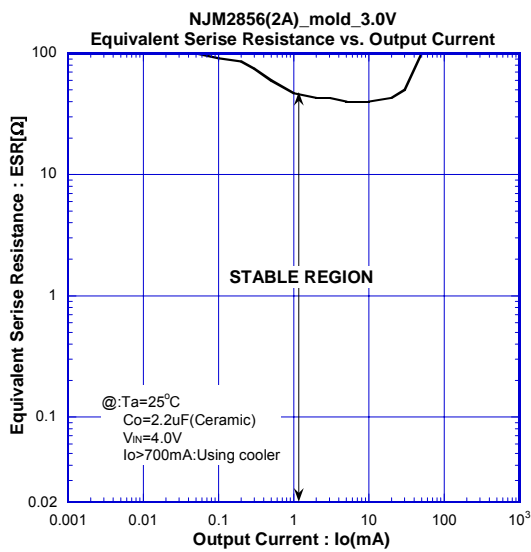

TYPICAL CHARACTERISTICS

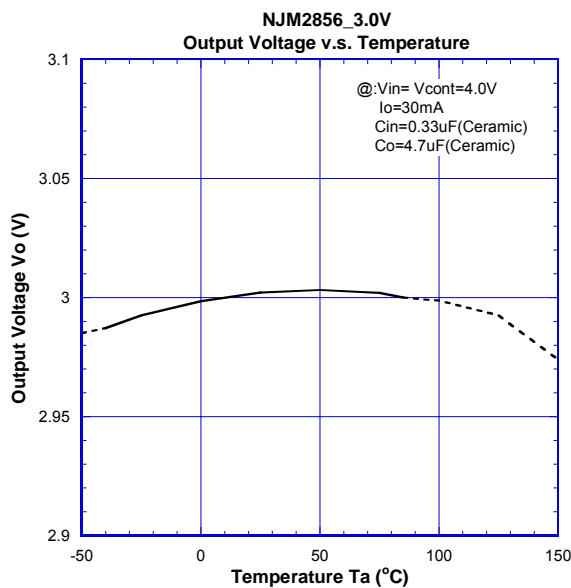
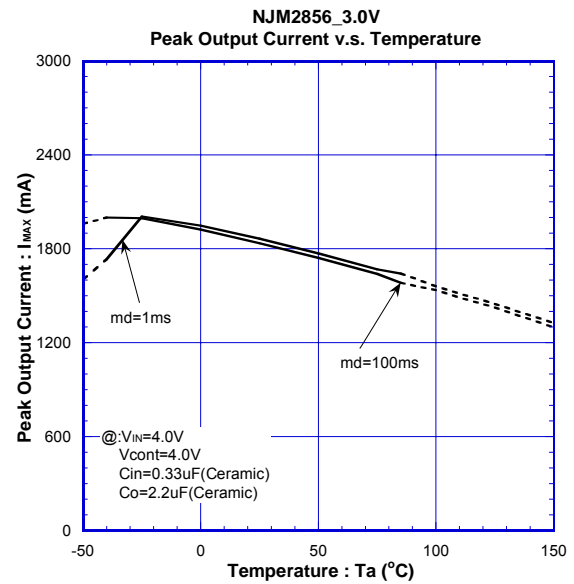
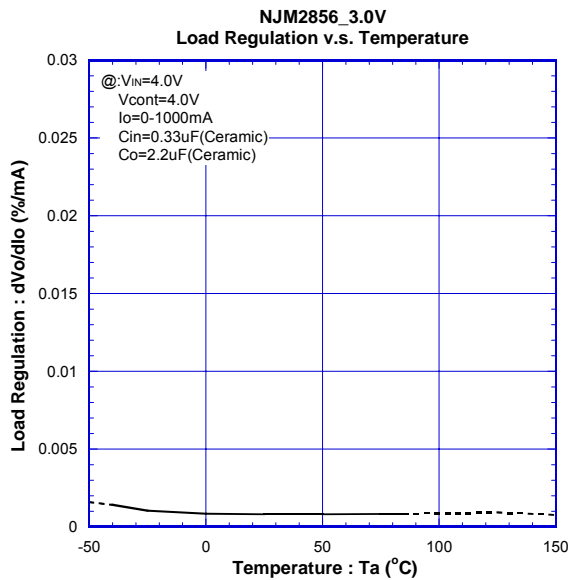
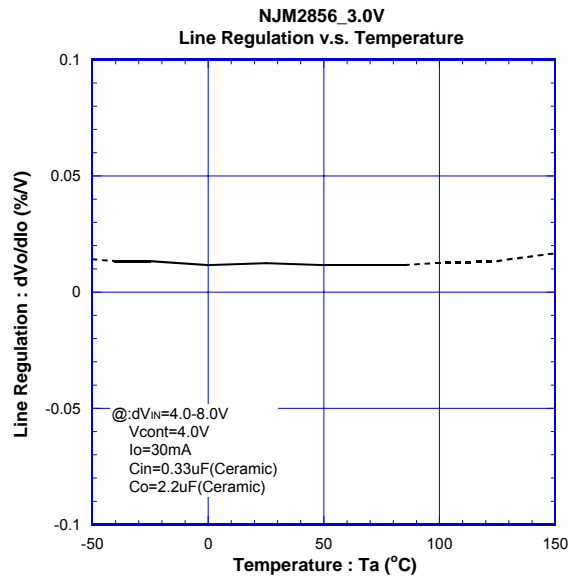
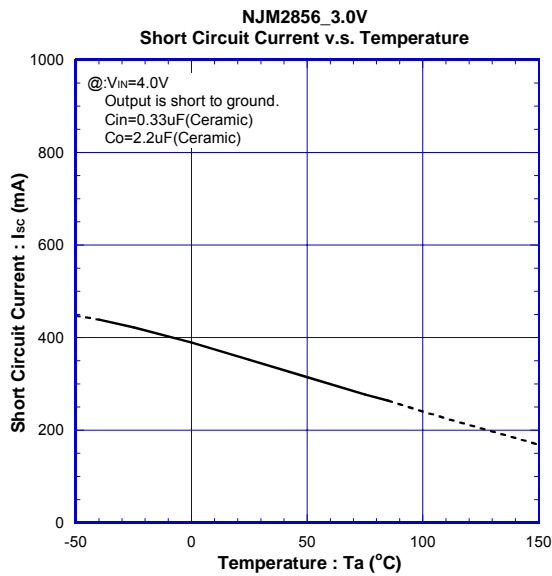

■ TYPICAL CHARACTERISTICS

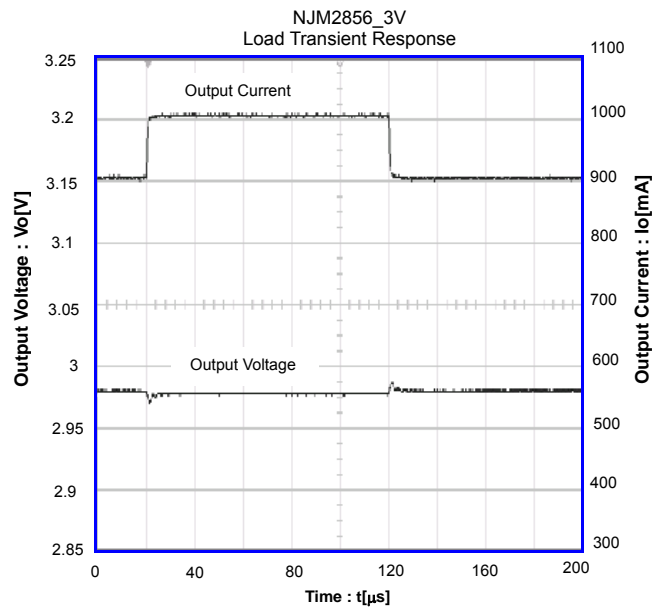
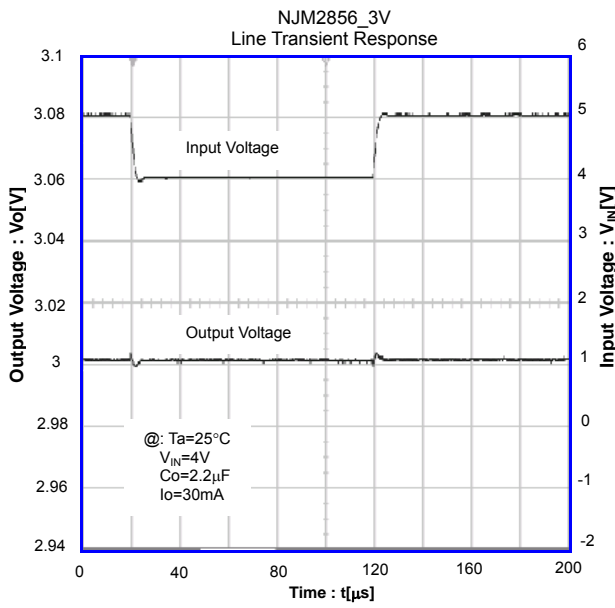

[CAUTION]

The specifications on this databook are only given for information, without any guarantee as regards either mistakes or omissions. The application circuits in this databook are described only to show representative usages of the product and not intended for the guarantee or permission of any right including the industrial rights.