

SKiiP 34NAB12T4V1

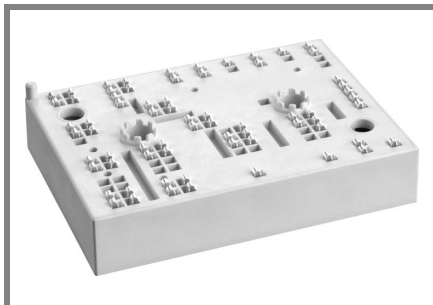

MiniSKiiP® 3

3-phase bridge rectifier +
brake chopper + 3-phase
bridge inverter
SKiiP 34NAB12T4V1

Features

- Trench 4 IGBT's
- Robust and soft freewheeling diodes in CAL technology
- Highly reliable spring contacts for electrical connections
- UL recognised file no. E63532

Remarks

- V_{CEsat} , V_F = chip level value
- Case temp. limited to $T_C = 125^\circ\text{C}$ max. (for baseplateless modules $T_C = T_S$)
- product rel. results valid for $T_{j \leq 150}$ (recomm. $T_{op} = -40 \dots +150^\circ\text{C}$)

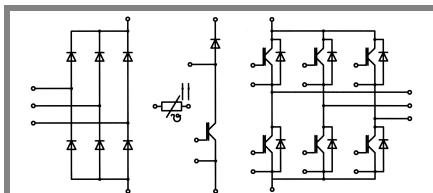

NAB

Absolute Maximum Ratings		$T_S = 25^\circ\text{C}$, unless otherwise specified		
Symbol	Conditions	Values	Units	
IGBT - Inverter, Chopper				
V_{CES}	$T_S = 25 (70)^\circ\text{C}$	1200	V	
I_C		52 (43)	A	
I_{CRM}		105	A	
V_{GES}		± 20	V	
T_j		-40 ... +175	$^\circ\text{C}$	
Diode - Inverter, Chopper				
I_F	$T_S = 25 (70)^\circ\text{C}$	44 (35)	A	
I_{FRM}		105	A	
T_j		-40 ... +175	$^\circ\text{C}$	
Diode - Rectifier				
V_{RRM}	$T_S = 70^\circ\text{C}$	1600	V	
I_F		46	A	
I_{FSM}		$t_p = 10 \text{ ms, sin } 180^\circ, T_j = 25^\circ\text{C}$	370	A
i^2t		$t_p = 10 \text{ ms, sin } 180^\circ, T_j = 25^\circ\text{C}$	680	A^2s
T_j		-40 ... +150	$^\circ\text{C}$	
Module				
I_{RMS}	per power terminal (20 A / spring)	80	A	
T_{stg}		-40 ... +125	$^\circ\text{C}$	
V_{isol}	AC, 1 min.	2500	V	

Characteristics		$T_S = 25^\circ\text{C}$, unless otherwise specified			
Symbol	Conditions	min.	typ.	max.	Units
IGBT - Inverter, Chopper					
V_{CEsat}	$I_{Cnom} = 35 \text{ A}, T_j = 25 (150)^\circ\text{C}$		1,85 (2,25)	2,05 (2,45)	V
$V_{GE(th)}$	$V_{GE} = V_{CE}, I_C = 1 \text{ mA}$	5	5,8	6,5	V
$V_{CE(TO)}$	$T_j = 25 (150)^\circ\text{C}$		0,8 (0,7)	0,9 (0,8)	V
r_T	$T_j = 25 (150)^\circ\text{C}$		30 (44)	33 (47)	$\text{m}\Omega$
C_{ies}	$V_{CE} = 25 \text{ V}, V_{GE} = 0 \text{ V}, f = 1 \text{ MHz}$		1,95		nF
C_{oes}	$V_{CE} = 25 \text{ V}, V_{GE} = 0 \text{ V}, f = 1 \text{ MHz}$		0,155		nF
C_{res}	$V_{CE} = 25 \text{ V}, V_{GE} = 0 \text{ V}, f = 1 \text{ MHz}$		0,115		nF
$R_{th(j-s)}$	per IGBT		0,85		K/W
$t_{d(on)}$	under following conditions		30		ns
t_r	$V_{CC} = 600 \text{ V}, V_{GE} = \pm 15 \text{ V}$		35		ns
$t_{d(off)}$	$I_{Cnom} = 35 \text{ A}, T_j = 150^\circ\text{C}$		300		ns
t_f	$R_{Gon} = R_{Goff} = 18 \Omega$		55		ns
E_{on}	inductive load		4,3		mJ
E_{off}			3,3		mJ
Diode - Inverter, Chopper					
$V_F = V_{EC}$	$I_{Fnom} = 35 \text{ A}, T_j = 25 (150)^\circ\text{C}$		2,3 (2,3)	2,6 (2,6)	V
$V_{(TO)}$	$T_j = 25 (150)^\circ\text{C}$		1,3 (0,9)	1,5 (1,1)	V
r_T	$T_j = 25 (150)^\circ\text{C}$		29 (40)	31 (43)	$\text{m}\Omega$
$R_{th(j-s)}$	per diode		1,2		K/W
I_{RRM}	under following conditions		34		A
Q_{rr}	$I_{Fnom} = 35 \text{ A}, V_R = 600 \text{ V}$		5,6		μC
E_{rr}	$V_{GE} = 0 \text{ V}, T_j = 150^\circ\text{C}$		2,4		mJ
	$di_F/dt = 1250 \text{ A}/\mu\text{s}$				
Diode - Rectifier					
V_F	$I_{Fnom} = 25 \text{ A}, T_j = 25^\circ\text{C}$		1,1		V
$V_{(TO)}$	$T_j = 150^\circ\text{C}$		0,8		V
r_T	$T_j = 150^\circ\text{C}$		13		$\text{m}\Omega$
$R_{th(j-s)}$	per diode		1,25		K/W
Temperature Sensor					
R_{ts}	3 %, $T_r = 25 (100)^\circ\text{C}$		1000(1670)		Ω
Mechanical Data					
w			95		g
M_s	Mounting torque	2		2,5	Nm

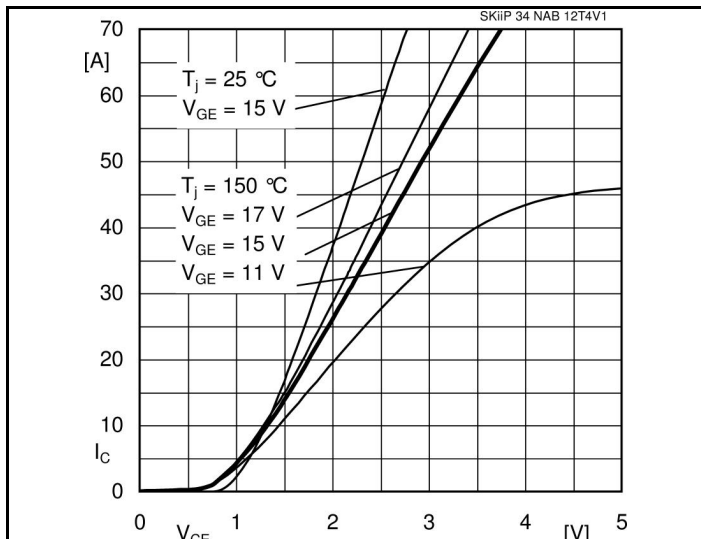

Fig. 1 Typ. output characteristic

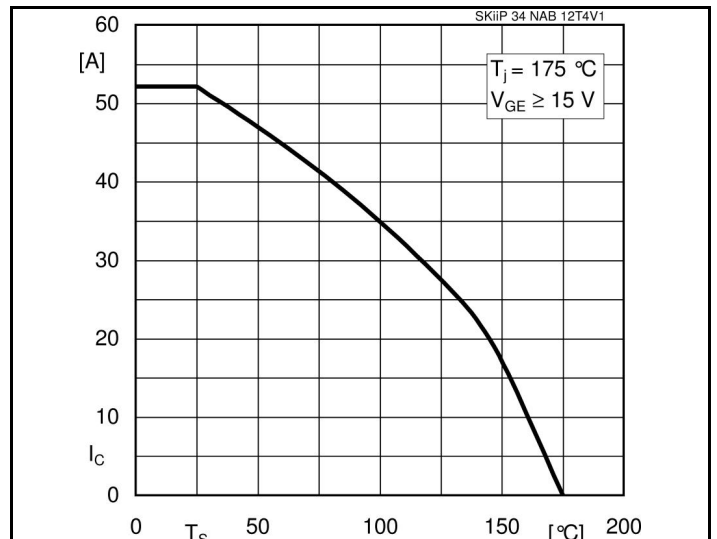

Fig. 2 Typ. rated current vs. temperature $I_C = f(T_S)$

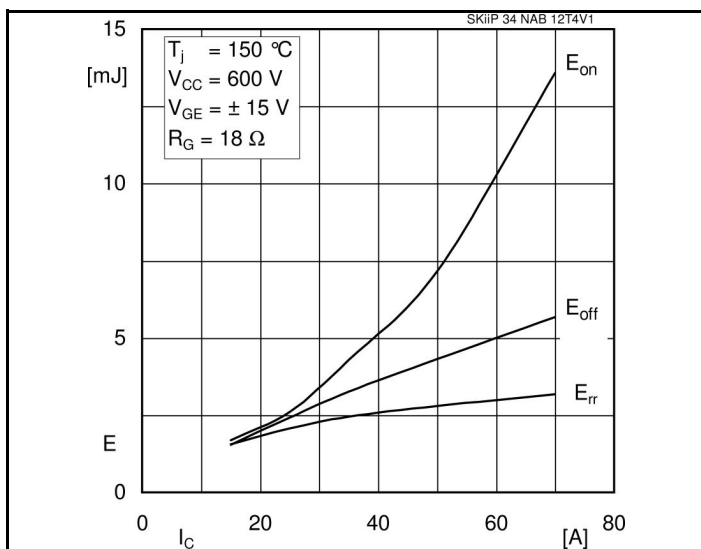

Fig. 3 Typ. turn-on /-off energy = $f(I_C)$

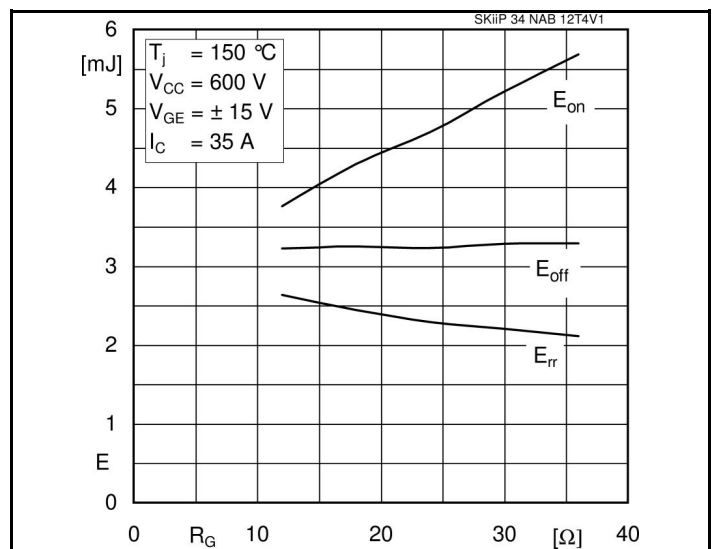

Fig. 4 Typ. turn-on /-off energy = $f(R_G)$

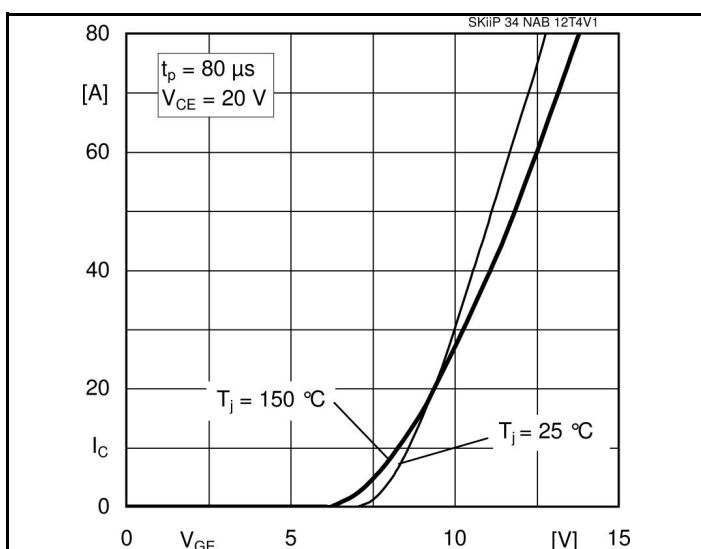

Fig. 5 Typ. transfer characteristic

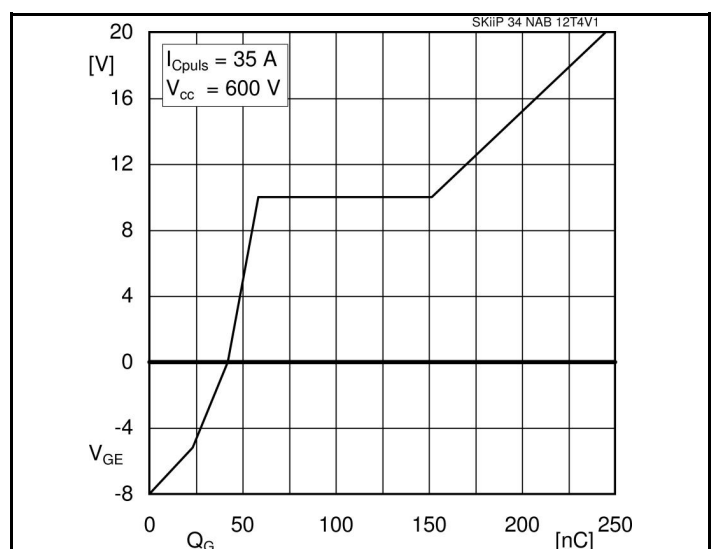
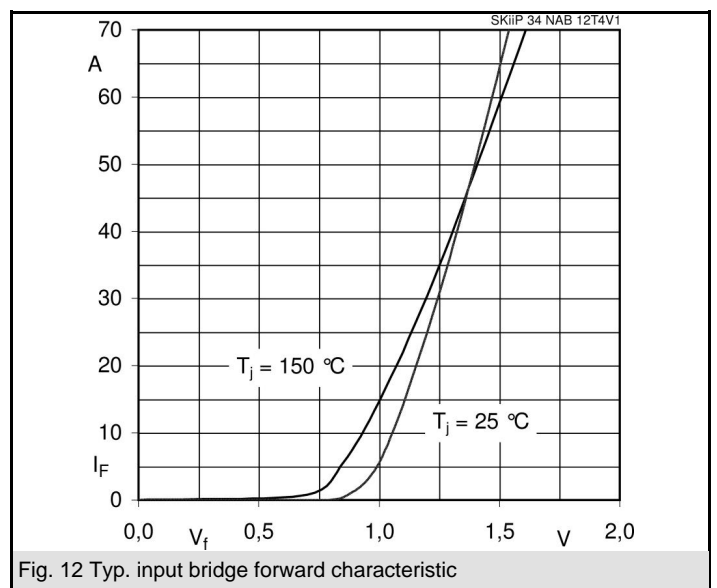
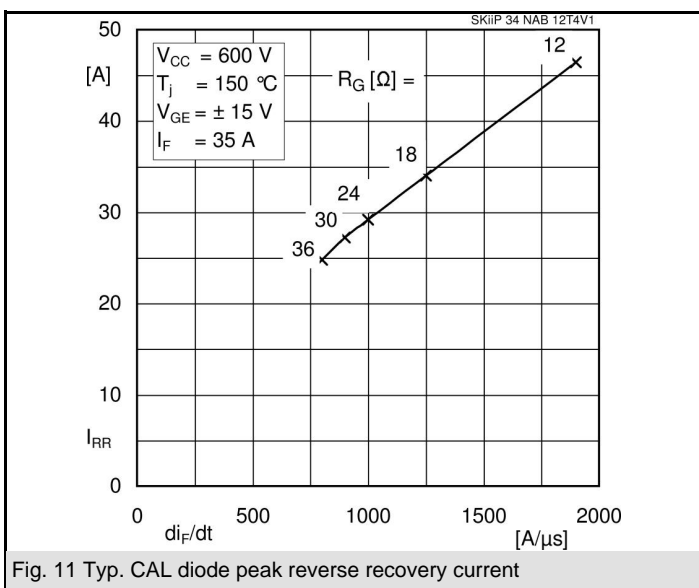
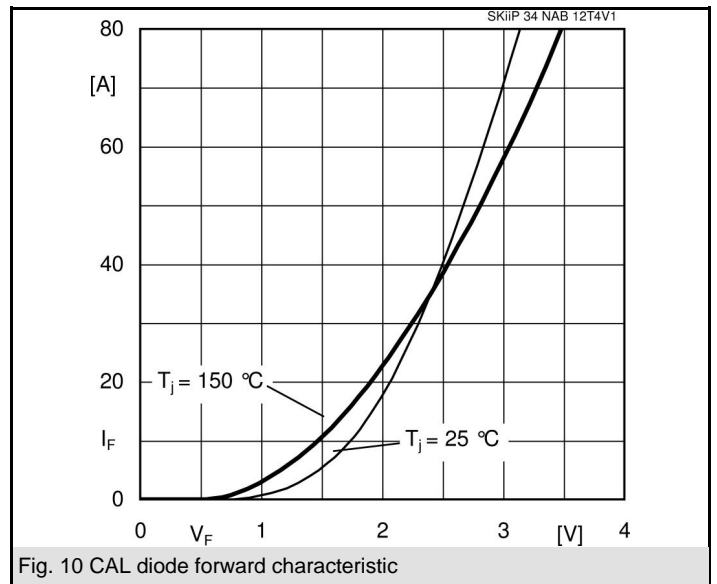
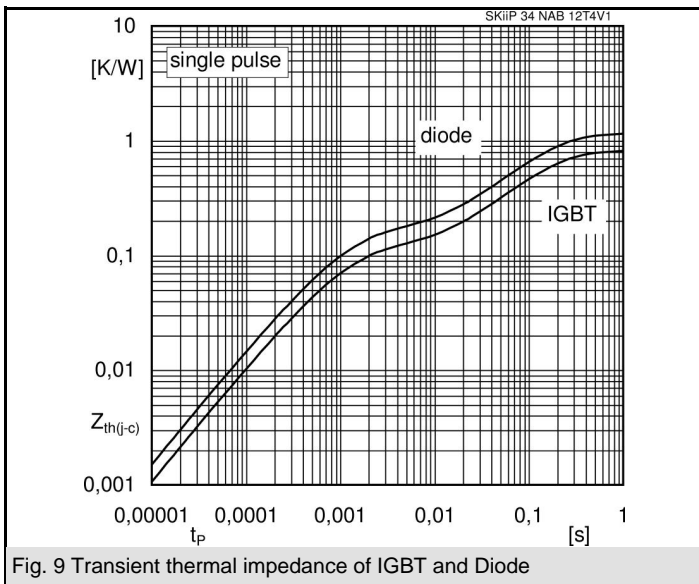
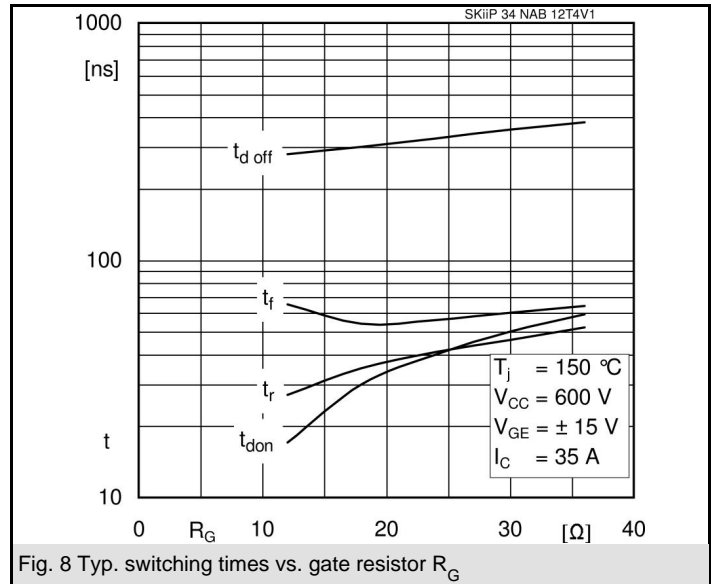
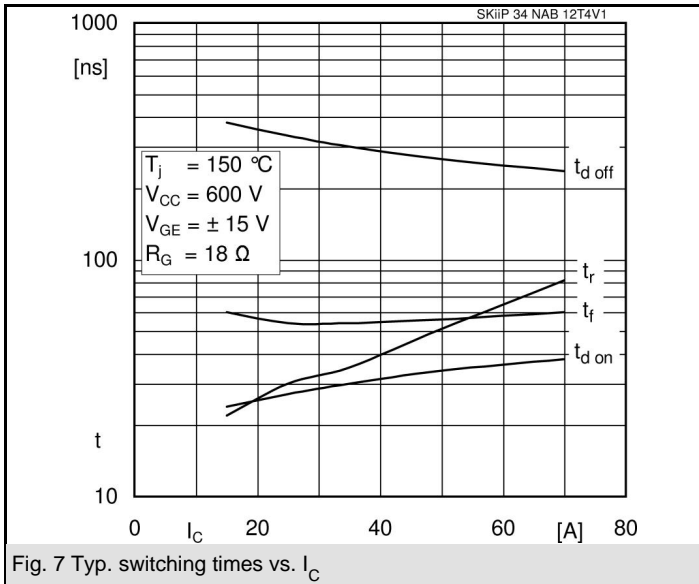
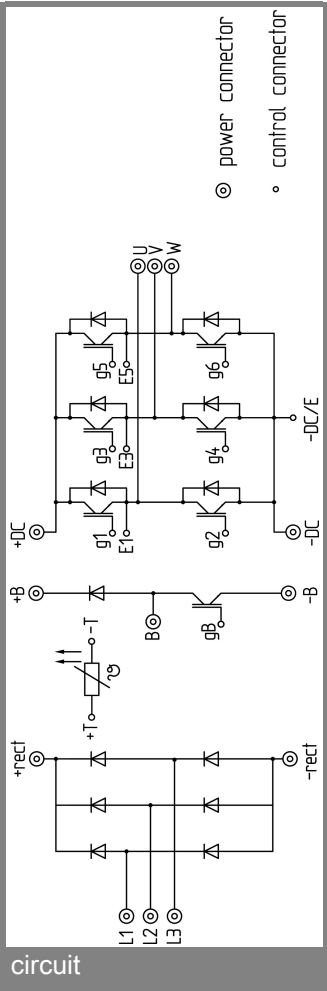
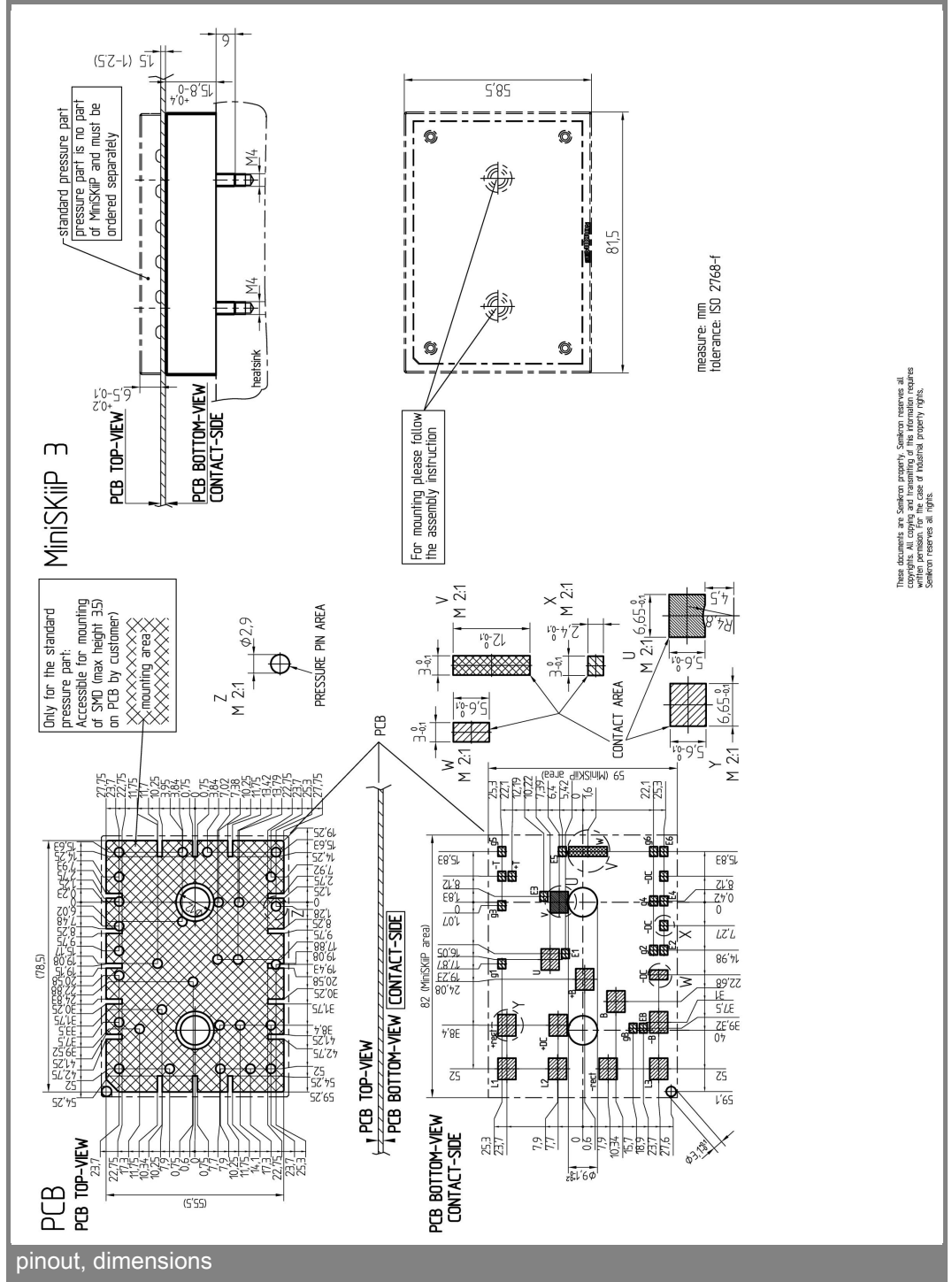

Fig. 6 Typ. gate charge characteristic





circuit



These documents are Semikron property. Semikron reserves all copyrights. All copying and releasing of the information requires written permission. In the case of industrial property rights, Semikron reserves all rights.

This is an electrostatic discharge sensitive device (ESDS), international standard IEC 60747-1, Chapter IX.

* The specifications of our components may not be considered as an assurance of component characteristics. Components have to be tested for the respective application. Adjustments may be necessary. The use of SEMIKRON products in life support appliances and systems is subject to prior specification and written approval by SEMIKRON. We therefore strongly recommend prior consultation of our personal.