



TEF6606

Advanced tuner on main-board IC

Rev. 01.03 — 12 June 2007

Objective data sheet

AFTRA T

1. General description

The TEF6606 is an AM/FM radio including Phase-Locked Loop (PLL) tuning system. The system is designed in such a way, that it can be used as a world-wide tuner covering common FM and AM bands for radio reception. All functions are controlled by the I²C-bus. Besides the basic feature set it provides a good weak signal processing function and a dynamic bandwidth control at FM reception.

2. Features

- FM tuner for Japan, Europe, US and OIRT reception
- AM tuner for Long Wave (LW), Medium Wave (MW) and Short Wave (SW) reception
- Integrated AM Radio Frequency (RF) selectivity
- Integrated PLL tuning system; controlled via I²C-bus including automatic low/high side Local Oscillator (LO) injection
- Fully integrated LO
- No alignment needed
- Very easy application on the main board
- No critical RF components
- Fully integrated Intermediate Frequency (IF) filters and FM stereo decoder
- Fully integrated FM noise blanker
- Fully integrated AM audio noise blanker
- Field strength (LEVEL), multipath [Wideband AM (WAM)], noise [UltraSonic Noise (USN)] and deviation dependent stereo blend
- Field strength (LEVEL), multipath (WAM), noise (USN) and deviation dependent High-Cut Control (HCC)
- Field strength (LEVEL), multipath (WAM) and noise (USN) dependent soft mute
- Adjacent channel and deviation dependent IF bandwidth control [Precision Adjacent Channel Suppression (PACS)]
- Single power supply
- Qualified in accordance with AEC-Q100

3. Quick reference data

Table 1. Quick reference data

Symbol	Parameter	Conditions	Min	Typ	Max	Unit
V _{CC}	supply voltage	on pins V _{CC1} and V _{CC2}	8	8.5	9	V
I _{CC}	supply current	into pins V _{CC1} , V _{CC2} and VREGSUP				
		FM	90	120	140	mA
		AM	100	134	150	mA
FM path						
f _{RF}	RF frequency	FM tuning range	65	-	108	MHz
V _{i(sens)}	input sensitivity voltage	(S+N)/N = 26 dB; including weak signal handling	-	5	-	dBμV
(S+N)/N	signal plus noise-to-noise ratio	V _{i(RF)} = 1 mV; Δf = 22.5 kHz	55	60	-	dB
THD	total harmonic distortion	mono; Δf = 75 kHz; V _{i(RF)} = 1 mV	-	0.4	0.8	%
α _{image}	image rejection	f _{RF(image)} = f _{RF(wanted)} ± 2 × f _{IF}	50	60	-	dB
α _{cs}	channel separation	V _{i(RF)} = 1 mV; data byte Fh bits CHSEP[2:0] = 100	26	40	-	dB
AM path						
f _{RF}	RF frequency	tuning range				
		AM (LW) tuning range	144	-	288	kHz
		AM (MW) tuning range	522	-	1710	kHz
		AM (SW) tuning range	2.94	-	18.135	MHz
V _{i(sens)}	input sensitivity voltage	S/N = 26 dB; data byte 3h bits DEMP[1:0] = 10; MW	-	34	-	dBμV
(S+N)/N	signal plus noise-to-noise ratio	V _{i(RF)} = 10 mV	50	56	-	dB
THD	total harmonic distortion	V _{i(RF)} = 1 mV; m = 80 %	-	0.7	1	%
α _{image}	image rejection	f _{RF(image)} = f _{RF(wanted)} ± 2 × f _{IF}	45	55	-	dB

4. Ordering information

Table 2. Ordering information

Type number	Package		Version
	Name	Description	
TEF6606T	SO32	plastic small outline package; 32 leads; body width 7.5 mm	SOT287-1

5. Block diagram

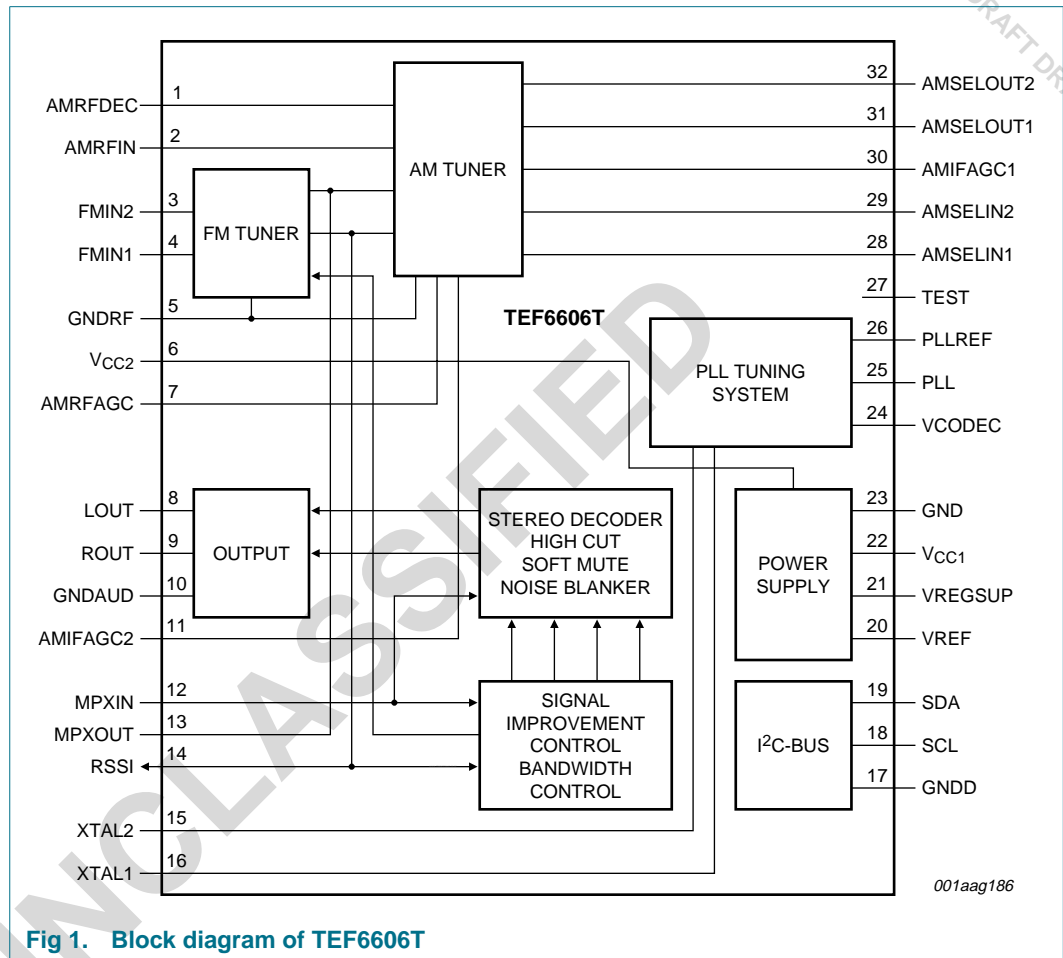

Fig 1. Block diagram of TEF6606T

6. Pinning information

6.1 Pinning

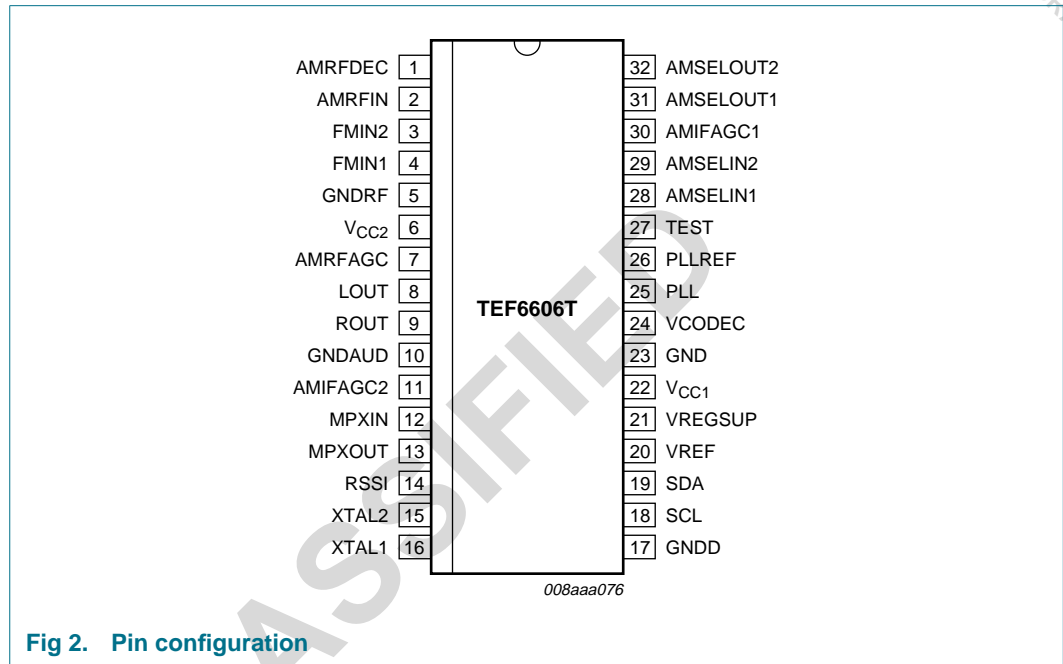

Fig 2. Pin configuration

6.2 Pin description

Table 3. Pin description

Symbol	Pin	Description
AMRFDEC	1	AM RF decoupling
AMRFIN	2	AM RF single-ended input
FMIN2	3	FM RF differential input 2
FMIN1	4	FM RF differential input 1
GDRF	5	RF ground
V _{CC2}	6	supply voltage 2
AMRFAGC	7	AM RF Automatic Gain Control (AGC)
LOUT	8	audio left output
ROUT	9	audio right output
GNDAUD	10	audio ground
AMIFAGC2	11	AM IF AGC 2
MPXIN	12	FM Multiplex (MPX) and AM audio input to stereo decoder
MPXOUT	13	FM MPX and AM audio output from tuner part
RSSI	14	Received Signal Strength Indication (RSSI)
XTAL2	15	4 MHz crystal oscillator pin 2
XTAL1	16	4 MHz crystal oscillator pin 1
GNDD	17	digital ground
SCL	18	I ² C-bus clock input

Table 3. Pin description ...continued

Symbol	Pin	Description
SDA	19	I ² C-bus data input and output
VREF	20	reference voltage decoupling
VREGSUP	21	supply voltage internal voltage regulators
V _{CC1}	22	supply voltage 1
GND	23	ground
VCODEC	24	decoupling for Voltage-Controlled Oscillator (VCO) supply voltage
PLL	25	PLL tuning voltage
PLLREF	26	PLL reference voltage
TEST	27	test pin; leave open in normal operation
AMSELIN1	28	AM selectivity input 1
AMSELIN2	29	AM selectivity input 2
AMIFAGC1	30	AM IF AGC 1
AMSELOUT1	31	AM selectivity output 1
AMSELOUT2	32	AM selectivity output 2

7. Functional description

7.1 FM tuner

The RF input signal is mixed to a low IF with inherent image suppression. The IF signal is filtered and demodulated. The complete signal path is fully integrated.

7.2 AM tuner

The RF signal is filtered and mixed to a low IF with inherent image suppression. The IF signals are filtered and demodulated. The signal path is highly integrated.

7.3 PLL tuning system

The PLL tuning system includes a fully integrated VCO. To avoid problems with unwanted signals on image side, the receiver controls automatically high-side or low-side injection.

7.4 Signal dependent FM IF bandwidth control

The bandwidth of the FM IF filter will be controlled by an adjacent channel detector and a deviation detector to optimize the reception.

7.5 FM stereo decoder

The MPX signal from the FM tuner is translated by the stereo decoder into a left and right audio channel. Good channel separation is achieved without alignment.

7.6 Weak signal processing and noise blanker

The reception quality of the station received is measured by a combination of detectors: field strength (LEVEL), multipath (WAM) and noise (USN). The audio processing functions soft mute, HCC and stereo blend are controlled accordingly to maintain the best possible

audio quality in case of poor signal conditions. Audio disturbances like e.g. ignition noise are suppressed by the noise blanker circuit, using USN detection on MPX and spike detection on the level signal.

7.7 I²C-bus transceiver

The IC can be controlled by means of the I²C-bus including fast mode.

8. I²C-bus protocol

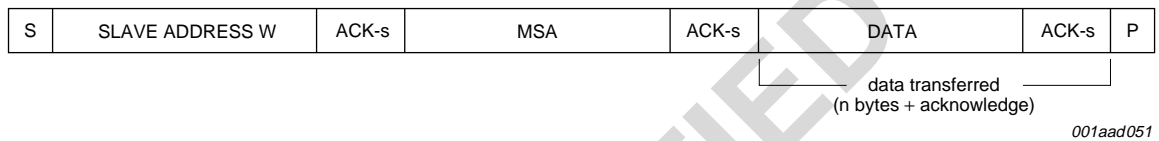

Fig 3. Write mode

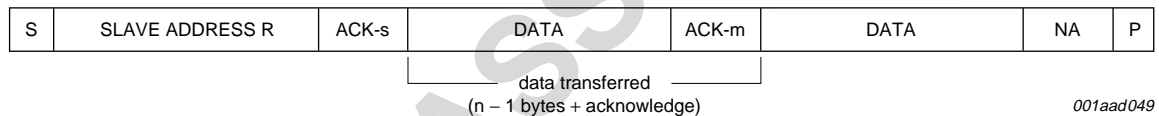

Fig 4. Read mode

Table 4. Description of I²C-bus format

Code	Description
S	START condition
Slave address W	1100 0000b
Slave address R	1100 0001b
ACK-s	acknowledge generated by the slave
ACK-m	acknowledge generated by the master
NA	not acknowledge
MSA	mode and subaddress byte
Data	data byte
P	STOP condition

8.1 Read mode

Table 5. Read register overview

Data byte	Name	Reference
0h	STATUS	Section 8.1.1
1h	LEVEL	Section 8.1.2
2h	USN_WAM	Section 8.1.3
3h	IFCOUNTER	Section 8.1.4
4h	ID	Section 8.1.5

8.1.1 Read mode: data byte STATUS

Table 6. STATUS - data byte 0h bit allocation

7	6	5	4	3	2	1	0
QRS1	QRS0	POR	STIN	-	-	TAS1	TAS0

Table 7. STATUS - data byte 0h bit description

Bit	Symbol	Description
7 and 6	QRS[1:0]	quality read status ^[1] 00 = no quality data available (tuning is in progress or quality data is settling) 01 = quality data (LEVEL, USN and WAM) available; for IF counter check the IFCS status 10 = AF update quality data available of LEVEL, USN, WAM and IF counter 11 = not used
5	POR	power-on reset indicator 0 = standard operation 1 = power on or power dip detected; I ² C-bus settings are lost
4	STIN	stereo indicator 0 = no pilot detected 1 = stereo pilot detected
3 and 2	-	not used
1 and 0	TAS[1:0]	tuning action state 00 = tuning not active; not muted 01 = muting in progress 10 = tuning in progress 11 = tuning ready and muted

[1] When PLL tuning is ready the quality detectors are reset for fastest result. In FM mode the first reliable quality result of LEVEL, USN and WAM is available from 1 ms after reset. In AM mode the first level result is available from 1 ms, gradually changing from peak LEVEL towards average LEVEL realizing the maximum attenuation of AM modulation influence from 32 ms. The quality result of an AF update tuning is stored and can be read at any time later.

8.1.2 Read mode: data byte LEVEL

Table 8. LEVEL - data byte 1h bit allocation

7	6	5	4	3	2	1	0
LEV7	LEV6	LEV5	LEV4	LEV3	LEV2	LEV1	LEV0

Table 9. LEVEL - data byte 1h bit description

Bit	Symbol	Description
7 to 0	LEV[7:0]	level detector (RSSI) output signal via fast level detector timing 0 to 255 = 0.25 V to 4.25 V

8.1.3 Read mode: data byte USN_WAM

Table 10. USN_WAM - data byte 2h bit allocation

7	6	5	4	3	2	1	0
USN3	USN2	USN1	USN0	WAM3	WAM2	WAM1	WAM0

Table 11. USN_WAM - data byte 2h bit description

Bit	Symbol	Description
7 to 4	USN[3:0]	FM ultrasonic noise 0 to 15 = 0 % to 100 % equivalent FM modulation at 100 kHz ultrasonic noise content (USN)
3 to 0	WAM[3:0]	FM wideband AM (multipath) 0 to 15 = 0 % to 100 % AM modulation at 20 kHz wideband AM content (WAM)

8.1.4 Read mode: data byte IFCOUNTER

Table 12. IFCOUNTER - data byte 3h bit allocation

7	6	5	4	3	2	1	0
IFCS1	IFCS0	IFCN	IFC4	IFC3	IFC2	IFC1	IFC0

Table 13. IFCOUNTER - data byte 3h bit description

Bit	Symbol	Description
7 and 6	IFCS[1:0]	IF counter status ^[1] 00 = no first counter result available 01 = first counter result available from 2 ms count time 10 = counter result available from 8 ms count time 11 = counter result available from 32 ms count time
5	IFCN	IF count result negative 0 = positive RF frequency difference 1 = negative RF frequency difference
4 to 0	IFC[4:0]	IF counter result; see Table 14

[1] When PLL tuning is ready the IF counter and other quality detectors are reset for fastest result. The first IF counter result is available from 2 ms after reset. Further results are available from 8 ms and 32 ms after reset, reducing the influence of FM modulation on the counter result. Later counter results are available at a count time of 32 ms.

Table 14. IF counter result

IFC4	IFC3	IFC2	IFC1	IFC0	Frequency difference	
					FM	AM
0	0	0	0	0	0 kHz to 5 kHz	0 kHz to 0.5 kHz
0	0	0	0	1	5 kHz to 10 kHz	0.5 kHz to 1 kHz
0	0	0	1	0	10 kHz to 15 kHz	1 kHz to 1.5 kHz
0	0	0	1	1	15 kHz to 20 kHz	1.5 kHz to 2 kHz
0	0	1	0	0	20 kHz to 25 kHz	2 kHz to 2.5 kHz

Table 14. IF counter result ...continued

IFC4	IFC3	IFC2	IFC1	IFC0	Frequency difference	
					FM	AM
:	:	:	:	:	:	:
1	1	1	1	0	150 kHz to 155 kHz	15 kHz to 15.5 kHz
1	1	1	1	1	> 155 kHz	> 15.5 kHz

8.1.5 Read mode: data byte ID

Table 15. ID - data byte 4h bit allocation

7	6	5	4	3	2	1	0
TINJ	IFBW2	IFBW1	IFBW0	-	ID2	ID1	ID0

Table 16. ID - data byte 4h bit description

Bit	Symbol	Description
7	TINJ	LO injection 0 = low injection LO 1 = high injection LO
6 to 4	IFBW[2:0]	IF bandwidth information 000 to 111 = narrow to wide FM IF filter bandwidth
3	-	not used
2 to 0	ID[2:0]	device type identification 010 = TEF6606

8.2 Write mode

Table 17. Write mode subaddress overview

Subaddress	Name	Default	Reference
0h	TUNER0	0010 0110b	Section 8.2.2
1h	TUNER1	1111 1010b	Section 8.2.3
2h	TUNER2	0000 0000b	Section 8.2.4
3h	RADIO	1000 0000b	Section 8.2.5
4h	SOFTMUTE0	0000 0000b	Section 8.2.6
5h	SOFTMUTE1	0000 0000b	Section 8.2.7
6h	SOFTMUTE2_FM	0000 0000b	Section 8.2.8
6h	SOFTMUTE2_AM	0000 0000b	Section 8.2.9
7h	HIGHCUT0	0000 0000b	Section 8.2.10
8h	HIGHCUT1	0000 0000b	Section 8.2.11
9h	HIGHCUT2	0000 0000b	Section 8.2.12
Ah	STEREO0	0000 0000b	Section 8.2.13
Bh	STEREO1	0000 0000b	Section 8.2.14
Ch	STEREO2	0000 0000b	Section 8.2.15
Dh	CONTROL	0001 0100b	Section 8.2.16
Eh	LEVEL_OFFSET	0100 0000b	Section 8.2.17
Fh	AM_LNA	0011 1100b	Section 8.2.18

8.2.1 Mode and subaddress byte for write

Table 18. MSA - mode and subaddress byte bit allocation

7	6	5	4	3	2	1	0
MODE2	MODE1	MODE0	0	SA3	SA2	SA1	SA0

Table 19. MSA - mode and subaddress byte bit description

Bit	Symbol	Description
7 to 5	MODE[2:0]	mode; see Table 20
4	-	not used, must be set to logic 0
3 to 0	SA[3:0]	subaddress

Table 20. Tuning action modes

MODE2	MODE1	MODE0	Symbol	Description
0	0	0	standard	write without tuning action
0	0	1	preset	tune to new station with short mute time; see Figure 5
0	1	0	search	tune to new station and stay muted; see Figure 6 and Figure 7
0	1	1	AF update	tune to AF station; store AF quality and tune back to main station; see Figure 8 and Figure 9
1	0	0	AF jump	tune to AF station in minimum mute time; see Figure 10 and Figure 11
1	0	1	AF check	tune to AF station and stay muted; swap; see Figure 12 , Figure 13 and Figure 14
1	1	0	mirror test	check current image situation and select injection mode for best result; see Figure 15
1	1	1	end	end; release mute from search mode or AF check mode

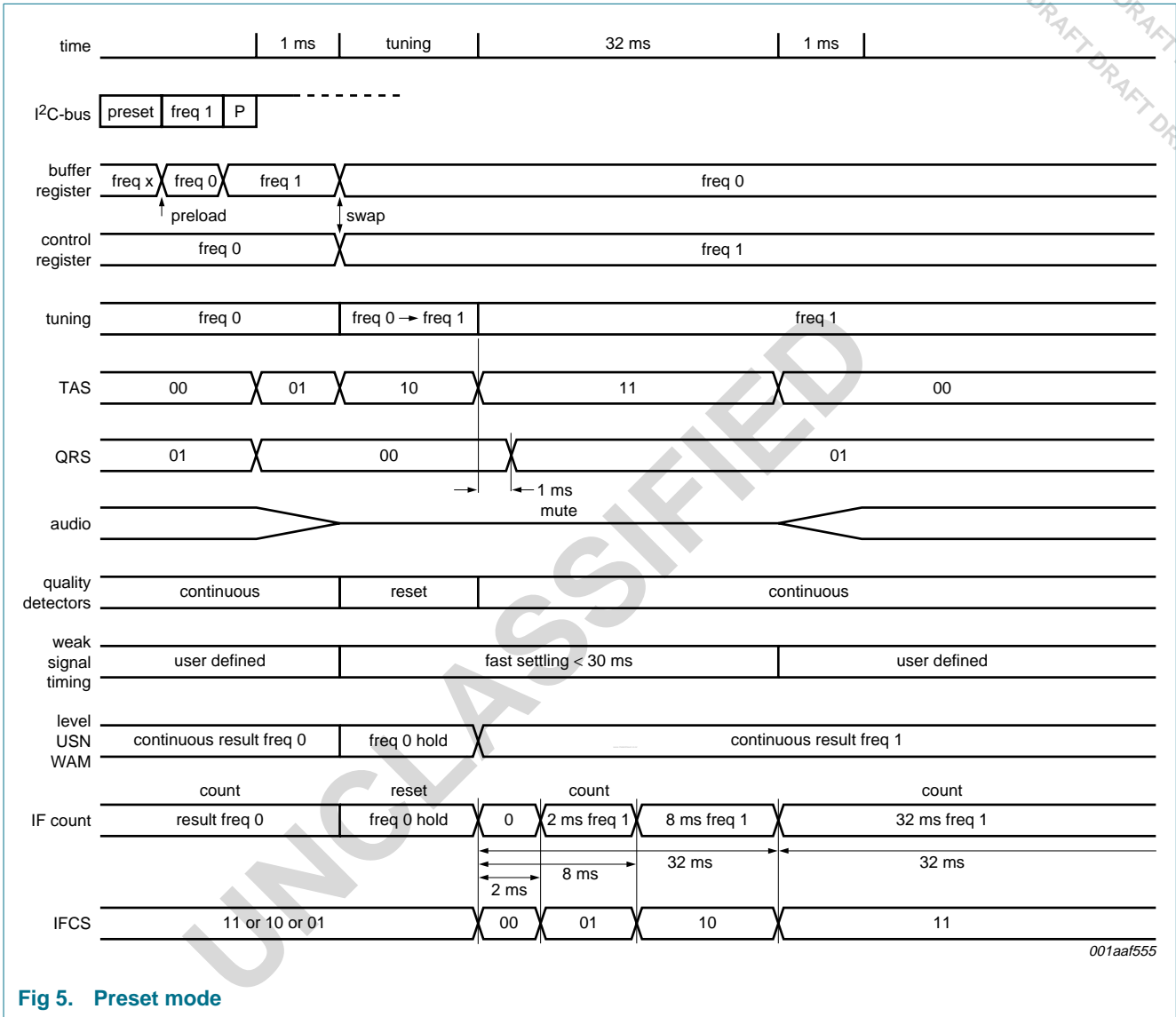

Fig 5. Preset mode

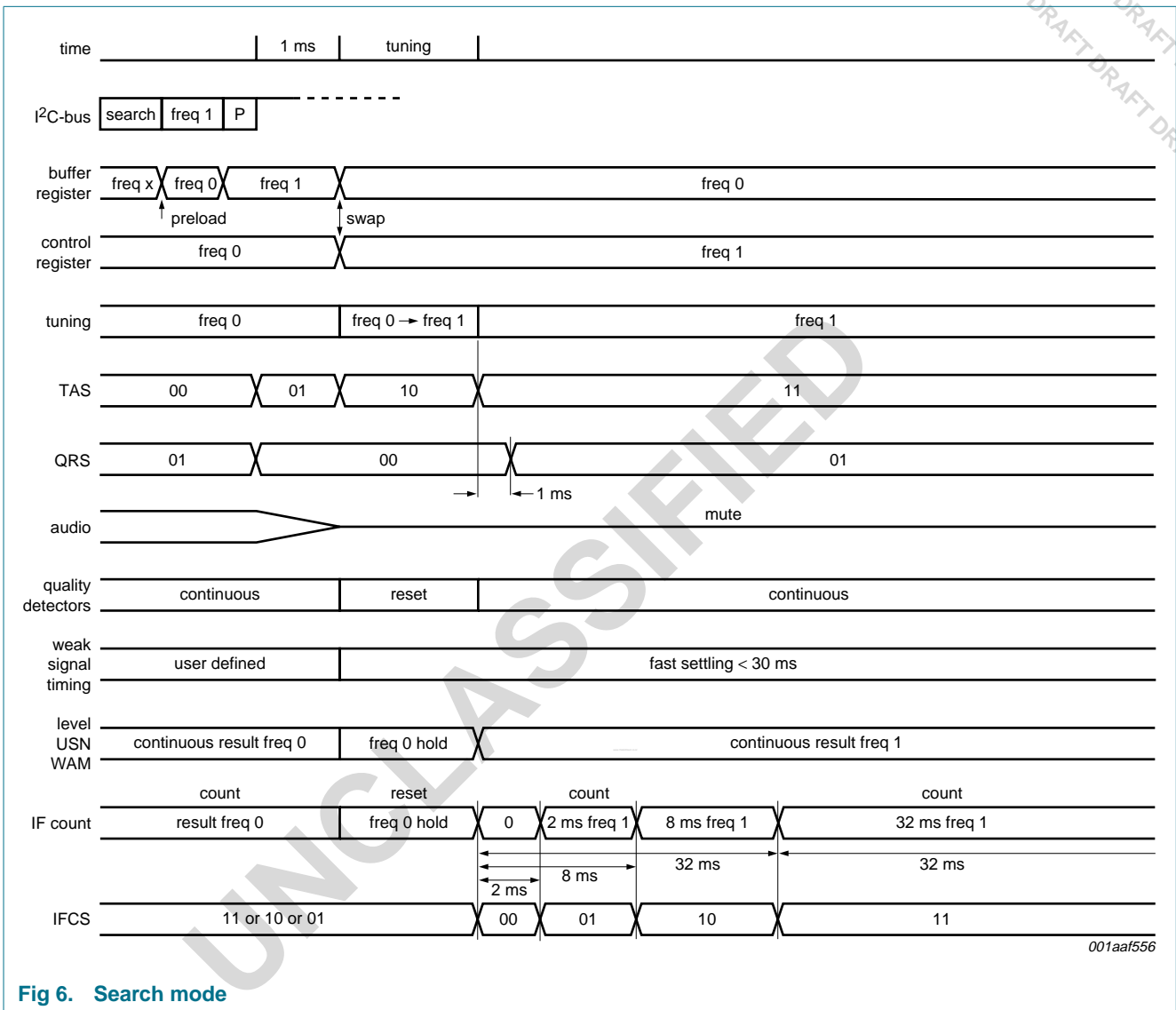

Fig 6. Search mode

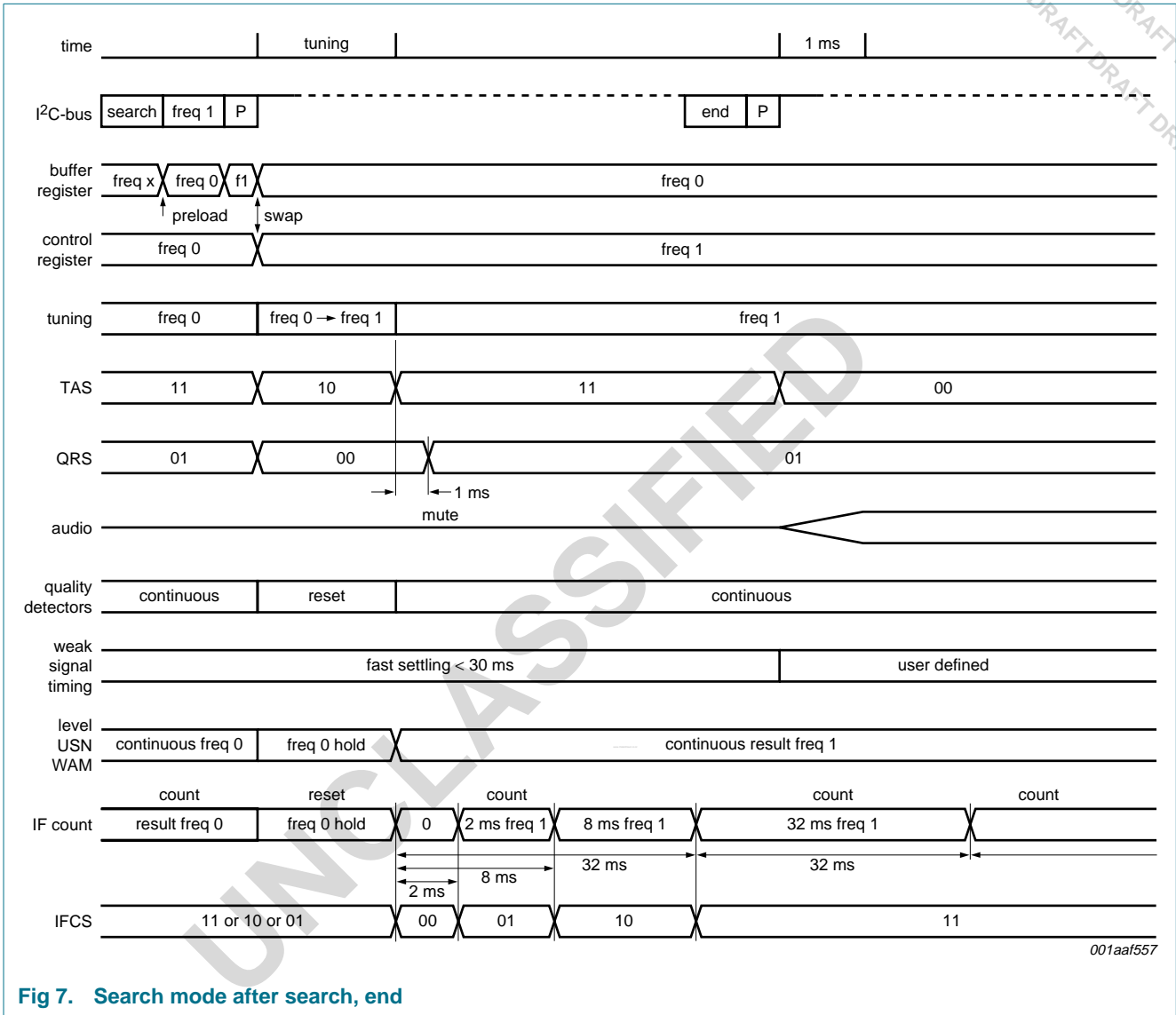

Fig 7. Search mode after search, end

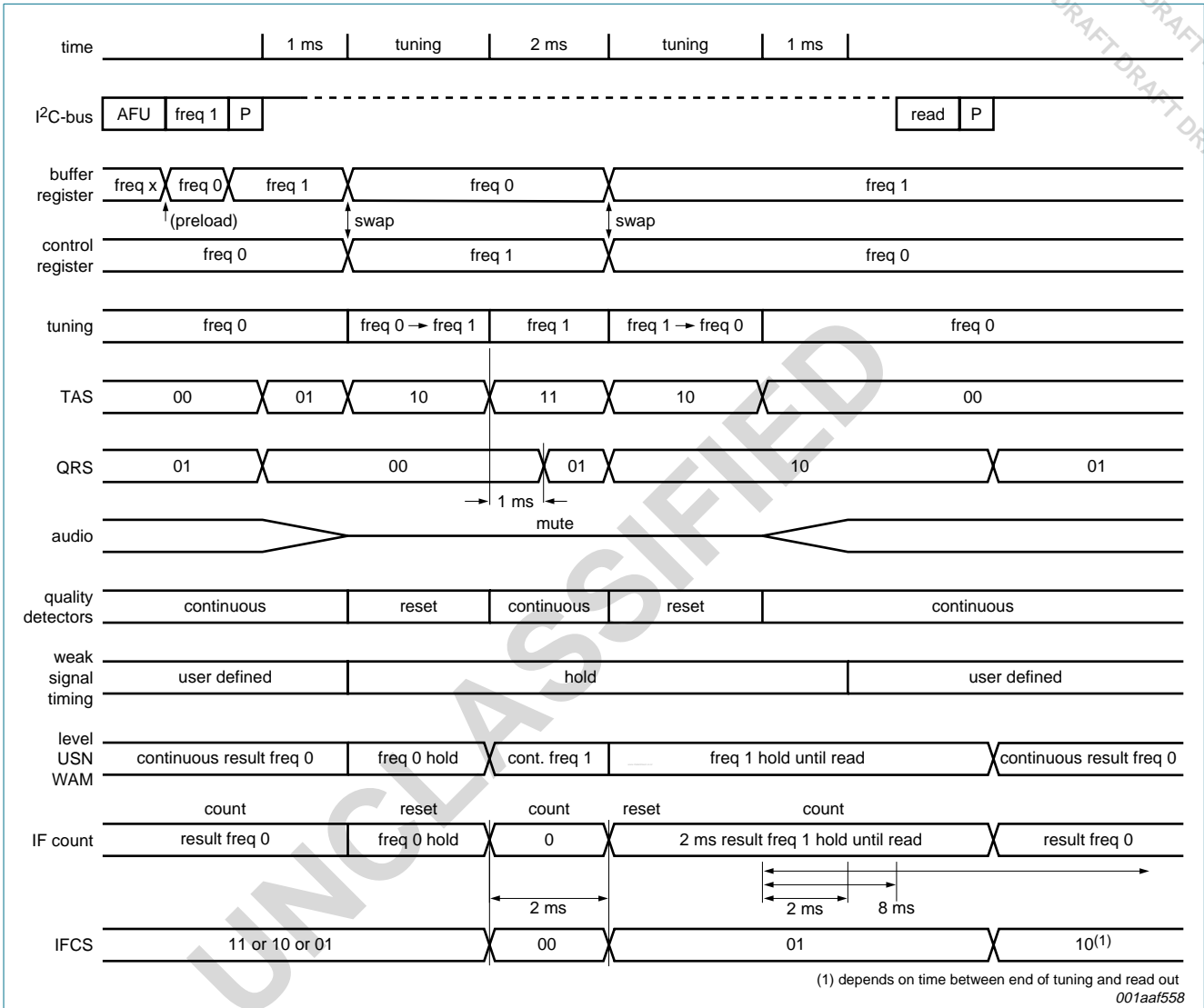

Fig 8. AF update mode

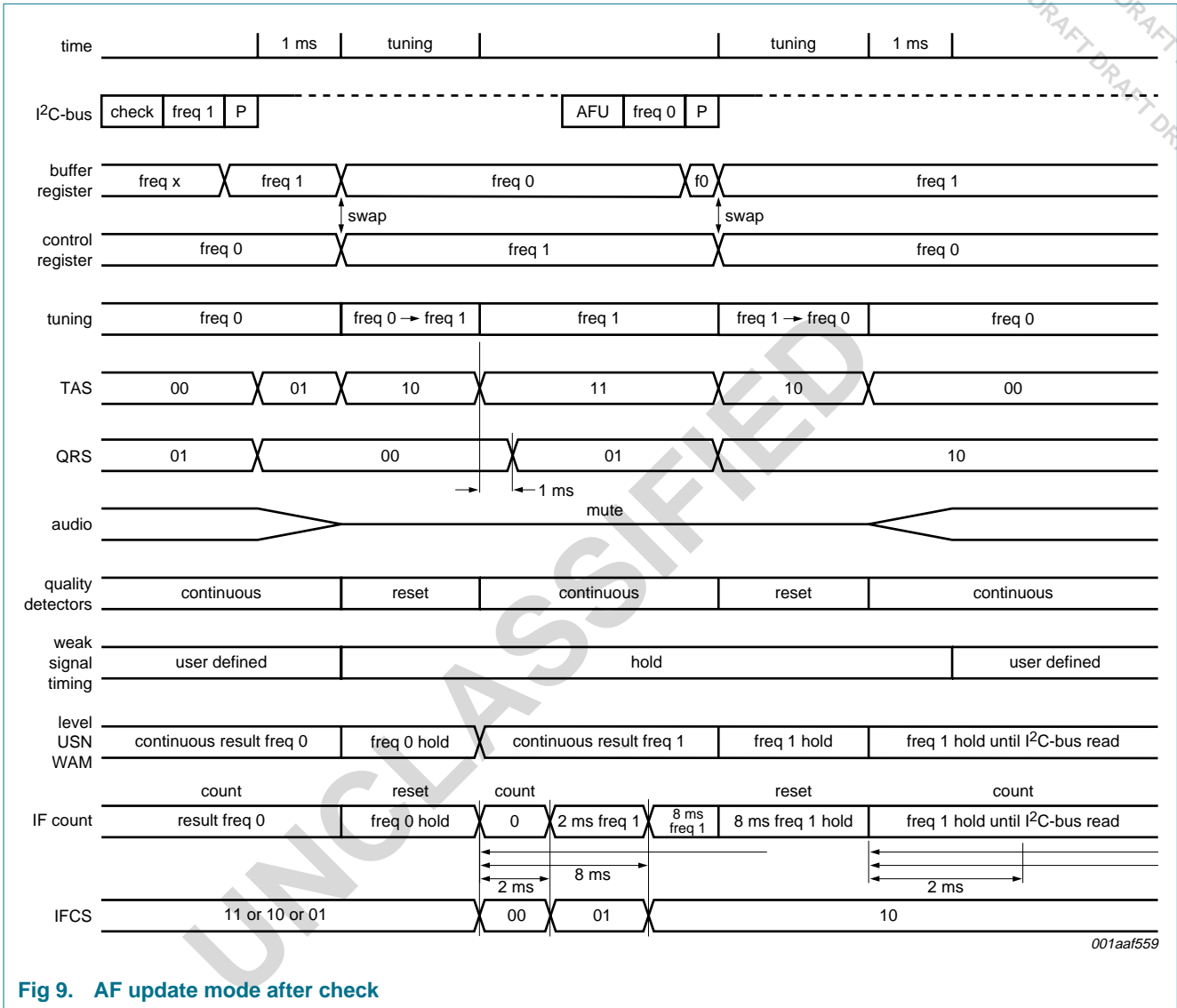

Fig 9. AF update mode after check

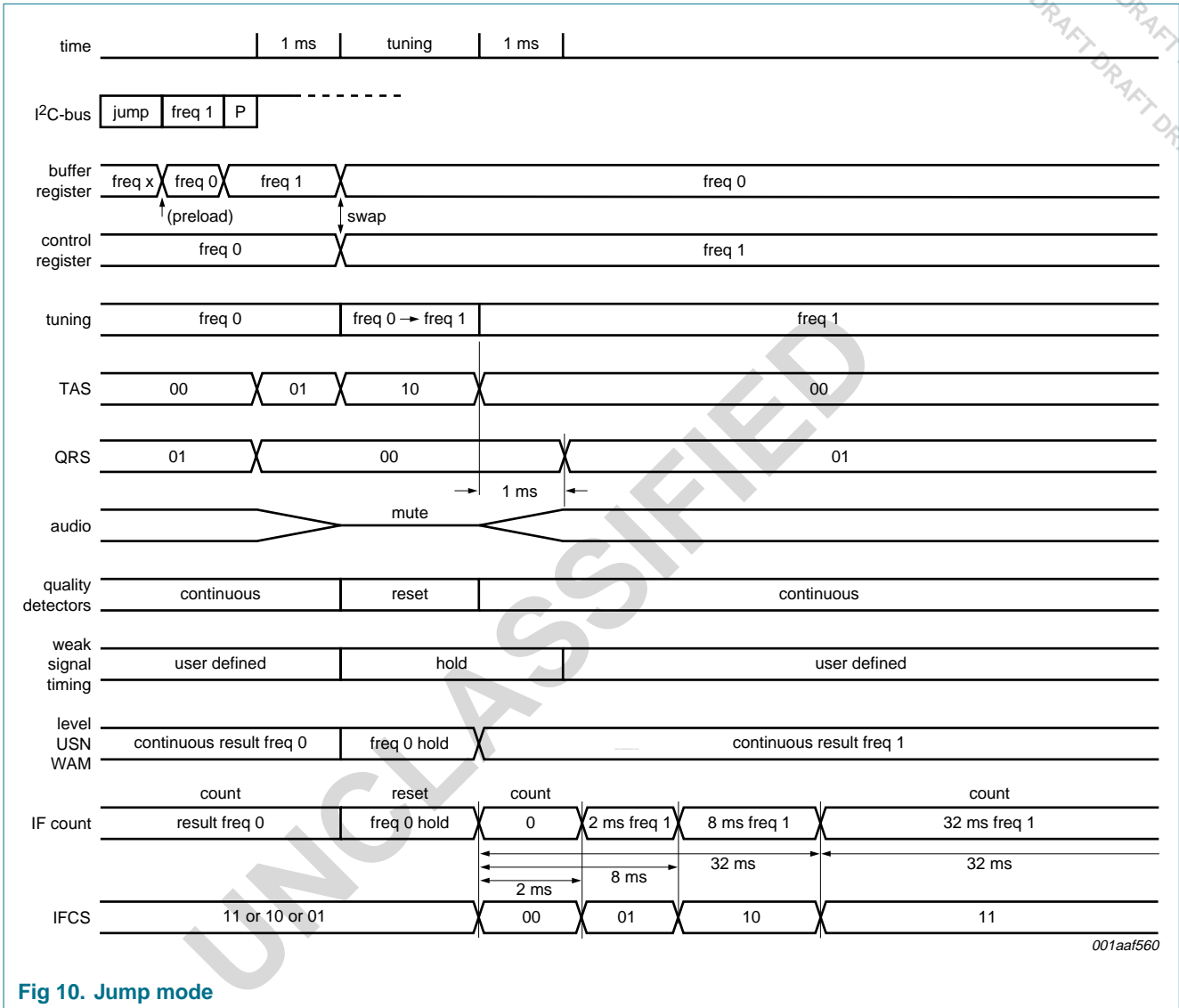

Fig 10. Jump mode

001aaf560

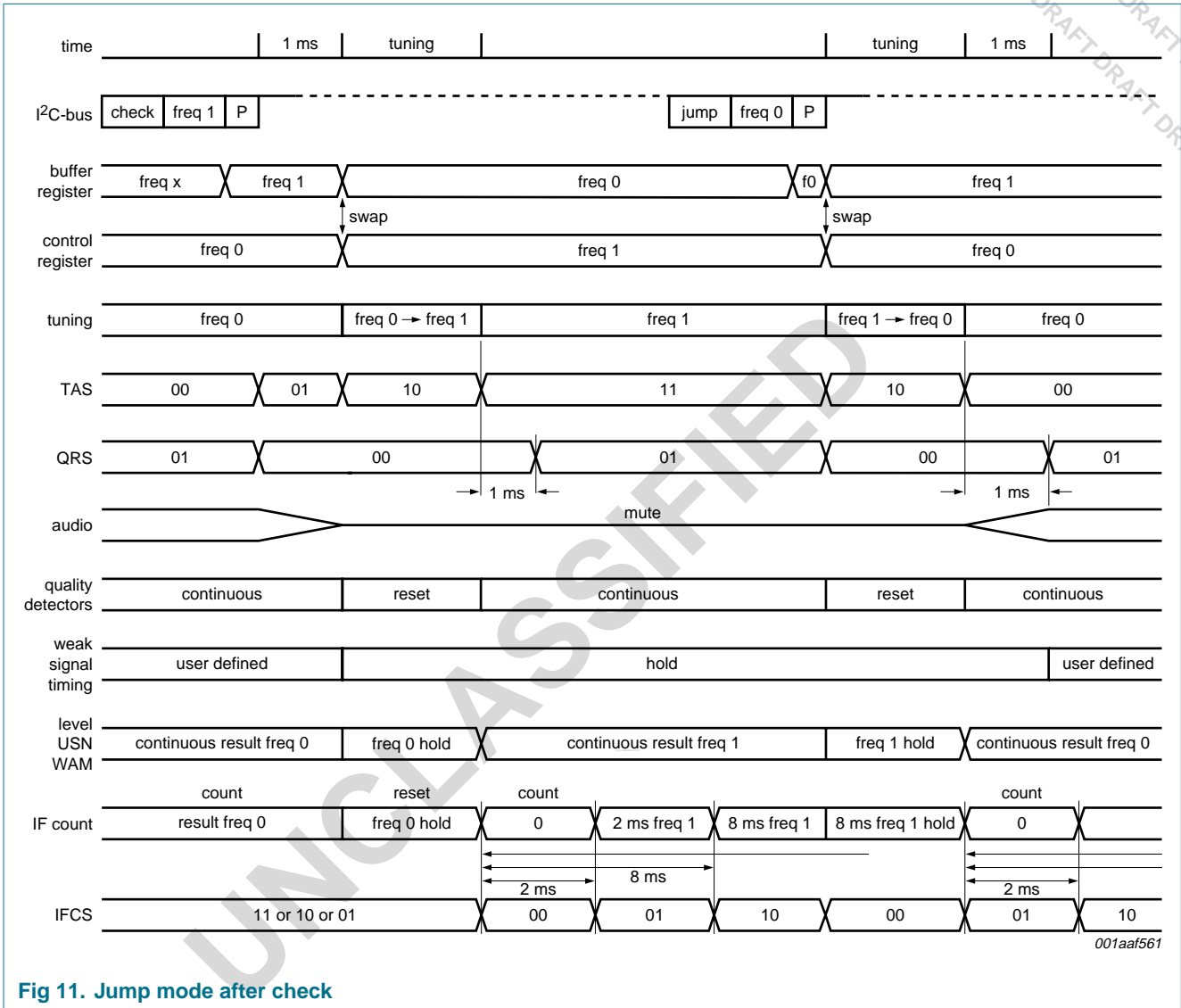

Fig 11. Jump mode after check

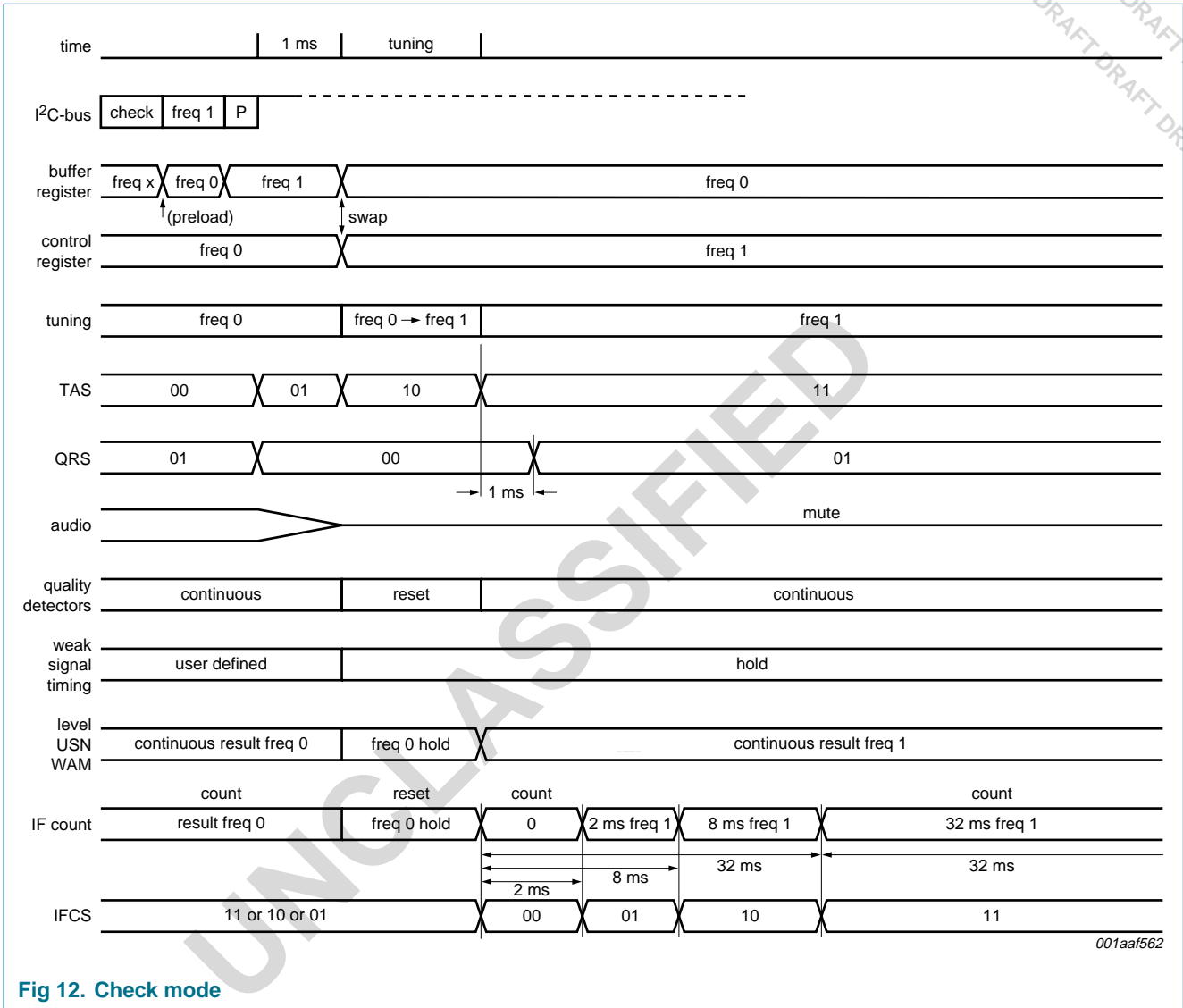

Fig 12. Check mode

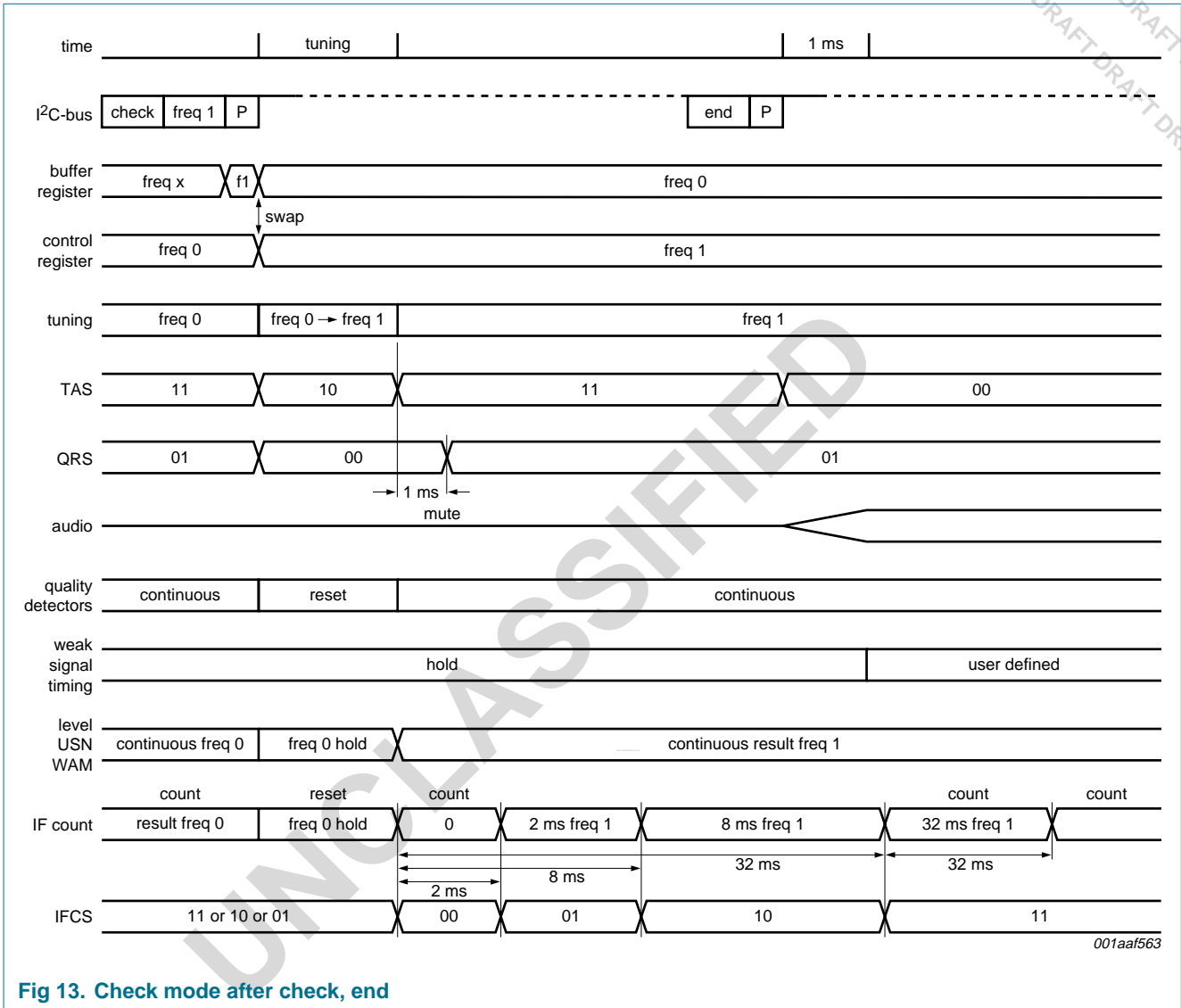

Fig 13. Check mode after check, end

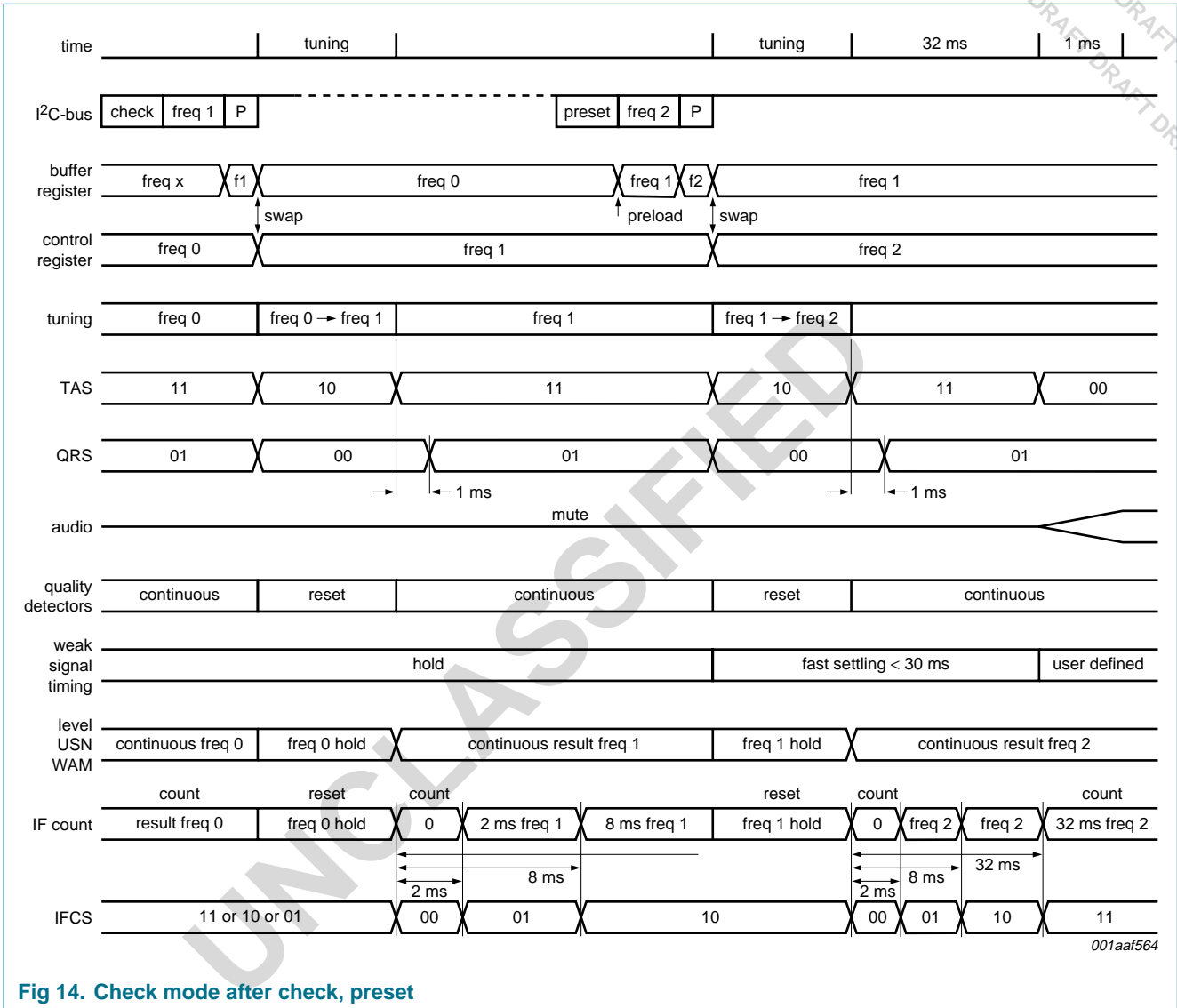

Fig 14. Check mode after check, preset

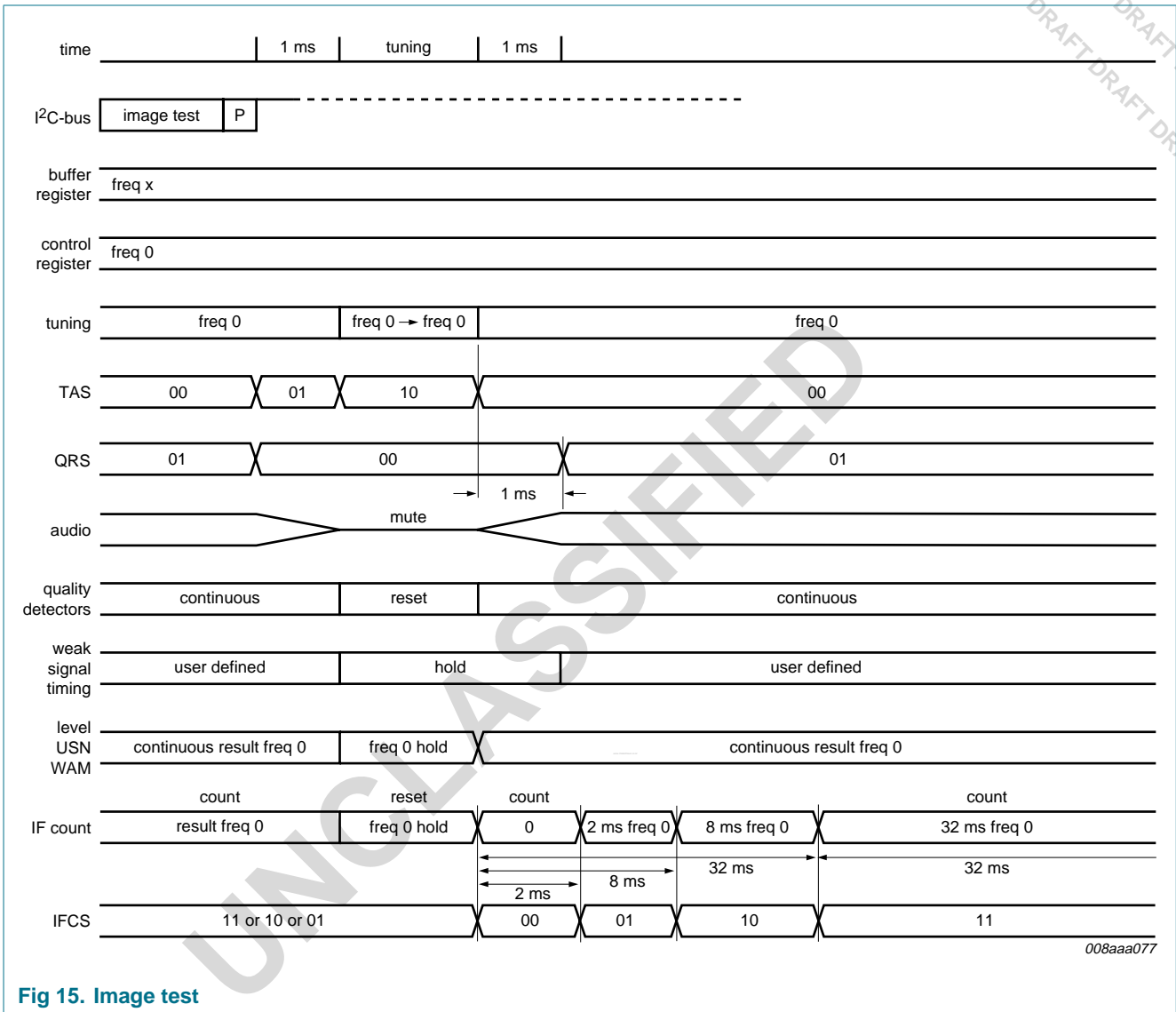

Fig 15. Image test

8.2.2 Write mode: data byte TUNER0

Table 21. TUNER0 - data byte 0h bit allocation with default setting

7	6	5	4	3	2	1	0
0	BAND1	BAND0	FREQ12	FREQ11	FREQ10	FREQ9	FREQ8
	0	1	0	0	1	1	0

Table 22. TUNER0 - data byte 0h bit description

Bit	Symbol	Description
7	-	not used, must be set to logic 0
6 and 5	BAND[1:0]	frequency band ^[1] 00 = AM: LW and MW 01 = FM: standard Europe, USA and Japan 10 = AM: SW 11 = FM: OIRT (eastern Europe)
4 to 0	FREQ[12:8]	upper byte of tuning frequency word ^[1] ; see Table 25

[1] For a correct tuning result a change in the BAND or FREQ setting should always be combined with a tuning action of modes 001 to 101.

8.2.3 Write mode: data byte TUNER1

Table 23. TUNER1 - data byte 1h bit allocation with default setting

7	6	5	4	3	2	1	0
FREQ7	FREQ6	FREQ5	FREQ4	FREQ3	FREQ2	FREQ1	FREQ0
1	1	1	1	1	0	1	0

Table 24. TUNER1 - data byte 1h bit description

Bit	Symbol	Description
7 to 0	FREQ[7:0]	lower byte of tuning frequency word ^[1] ; see Table 25

[1] For a correct tuning result a change in the BAND or FREQ setting should always be combined with a tuning action of MODE[2:0] = 001 to 101.

Table 25. Tuning frequency

BAND	FREQ[12:0] value	Reception frequency	Frequency correlation	Step
AM: LW and MW	144 to 1720	144 kHz to 1720 kHz	$FREQ[12:0] = f_{RF} \text{ [kHz]}$	1 kHz
FM: standard Europe, USA and Japan	1520 to 2160	76 MHz to 108 MHz	$FREQ[12:0] = f_{RF} \text{ [MHz]} \times 20$	50 kHz
AM: SW	588 to 3627	2940 kHz to 18135 kHz	$FREQ[12:0] = f_{RF} \text{ [kHz]} \times 5$	5 kHz
FM: OIRT (eastern Europe)	6581 to 7400	65 MHz to 74 MHz	$FREQ[12:0] = f_{RF} \text{ [MHz]} \times 100$	10 kHz

8.2.4 Write mode: data byte TUNER2

Table 26. TUNER2 - data byte 2h bit allocation with default setting

7	6	5	4	3	2	1	0
RFAGC1	RFAGC0	INJ1	INJ0	0	FMBW2	FMBW1	FMBW0
0	0	0	0		0	0	0

Table 27. TUNER2 - data byte 2h bit description

Bit	Symbol	Description
7 and 6	RFAGC[1:0]	AM RF AGC sensitivity control 00 = AGC threshold not reduced 01 = AGC threshold reduced by 2 dB 10 = AGC threshold reduced by 4 dB 11 = AGC threshold reduced by 6 dB FM RF AGC sensitivity control 00 = AGC threshold reduced by 6 dB 01 = AGC threshold reduced by 4 dB 10 = AGC threshold reduced by 2 dB 11 = AGC threshold not reduced
5 and 4	INJ[1:0]	injection ^[1] 00 = automatic injection 01 = high injection LO 10 = low injection LO 11 = undefined, do not use
3	-	not used, must be set to logic 0
2 to 0	FMBW[2:0]	FM bandwidth control 0 = dynamic mode (optimum bandwidth is selected depending on reception conditions) 001 to 111 = narrow to wide FM IF filter bandwidth

[1] For a correct tuning result a change in the INJ setting should always be combined with MODE[2:0] = 110 or a tuning action of MODE[2:0] = 001 to 101.

8.2.5 Write mode: data byte RADIO

Table 28. RADIO - data byte 3h bit allocation with default setting

7	6	5	4	3	2	1	0
NBS1	NBS0	LOCUT	MONO	DEMP1	DEMP0	0	OUTA
1	0	0	0	0	0	0	0

Table 29. RADIO - data byte 3h bit description

Bit	Symbol	Description
7 and 6	NBS[1:0]	AM and FM noise blanker sensitivity control 00 = AM and FM noise blanker off 01 = low AM and FM noise blanker sensitivity 10 = medium AM and FM noise blanker sensitivity 11 = high AM and FM noise blanker sensitivity
5	LOCUT	control of audio high-pass filter 0 = no limitation (-3 dB at 7 Hz) 1 = high-pass function (-3 dB at 100 Hz)
4	MONO	mono/stereo switch 0 = FM stereo enabled 1 = FM stereo disabled (forced mono)
3 and 2	DEMP[1:0]	de-emphasis setting 00 = 50 μ s de-emphasis 01 = 75 μ s de-emphasis 10 = 103 μ s low-pass 11 = not used
1	-	not used, must be set to logic 0
0	OUTA	audio output gain 0 = low audio gain at LOUT and ROUT 1 = high audio gain at LOUT and ROUT

8.2.6 Write mode: data byte SOFTMUTE0

Table 30. SOFTMUTE0 - data byte 4h bit allocation with default setting

7	6	5	4	3	2	1	0
0	0	0	MAT2	MAT1	MAT0	MRT1	MRT0
			0	0	0	0	0

Table 31. SOFTMUTE0 - data byte 4h bit description

Bit	Symbol	Description
7 to 5	-	not used, must be set to logic 0
4 to 2	MAT[2:0]	soft mute slow attack time; see Table 32
1 and 0	MRT[1:0]	soft mute slow recovery time 00 = 2 times attack time 01 = 4 times attack time 10 = 8 times attack time 11 = 16 times attack time

Table 32. Soft mute attack time

MAT2	MAT1	MAT0	Soft mute attack time
0	0	0	60 ms
0	0	1	125 ms
0	1	0	250 ms
0	1	1	0.5 s
1	0	0	1 s
1	0	1	2 s
1	1	0	4 s
1	1	1	8 s

8.2.7 Write mode: data byte SOFTMUTE1

Table 33. SOFTMUTE1 - data byte 5h bit allocation with default setting

7	6	5	4	3	2	1	0
MFOL	MSOL	0	MST2	MST1	MST0	MSL1	MSL0
0	0		0	0	0	0	0

Table 34. SOFTMUTE1 - data byte 5h bit description

Bit	Symbol	Description
7	MFOL	soft mute fast on level 0 = no fast control on level 1 = fast control on level active
6	MSOL	soft mute slow on level 0 = no slow control on level 1 = slow control on level active
5	-	not used, must be set to logic 0
4 to 2	MST[2:0]	soft mute start on level 000 to 111 = high threshold to low threshold of weak signal soft mute control; see Figure 16 and Figure 17
1 and 0	MSL[1:0]	soft mute slope on level 00 to 11 = low steepness to high steepness of slope of weak signal soft mute control; see Figure 16 and Figure 17

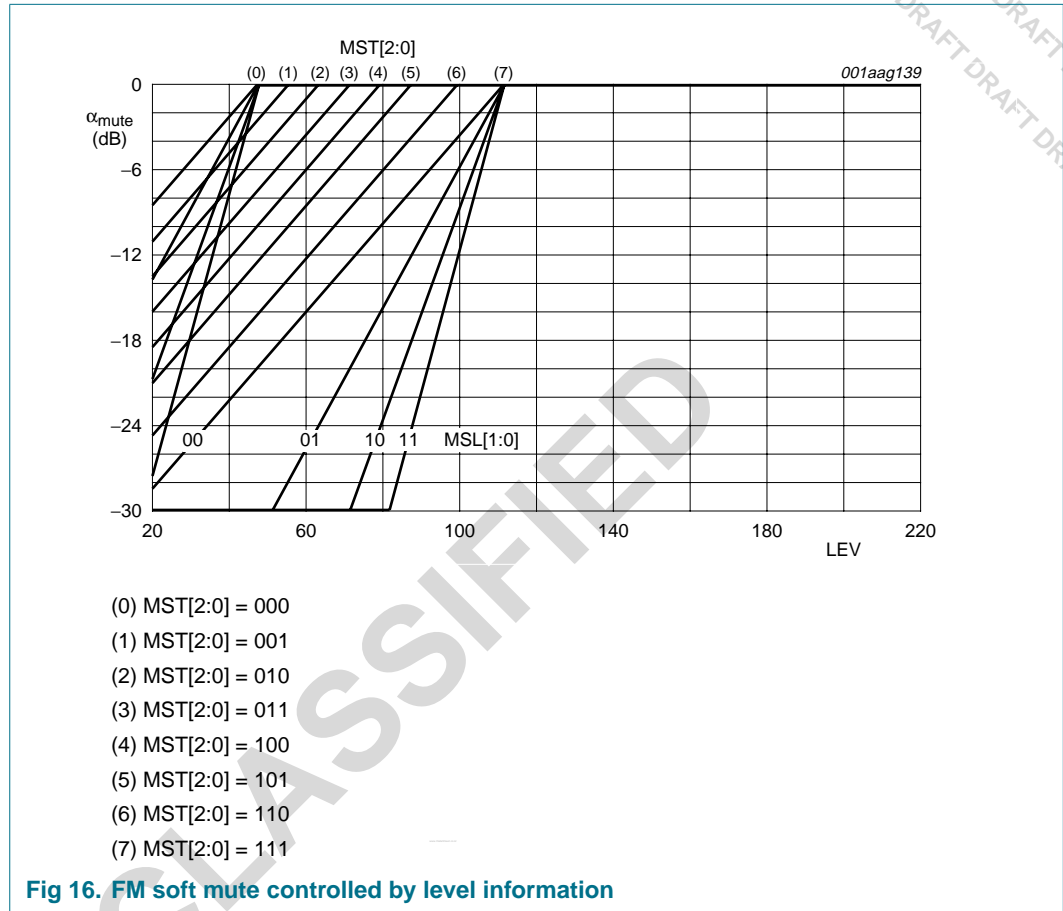

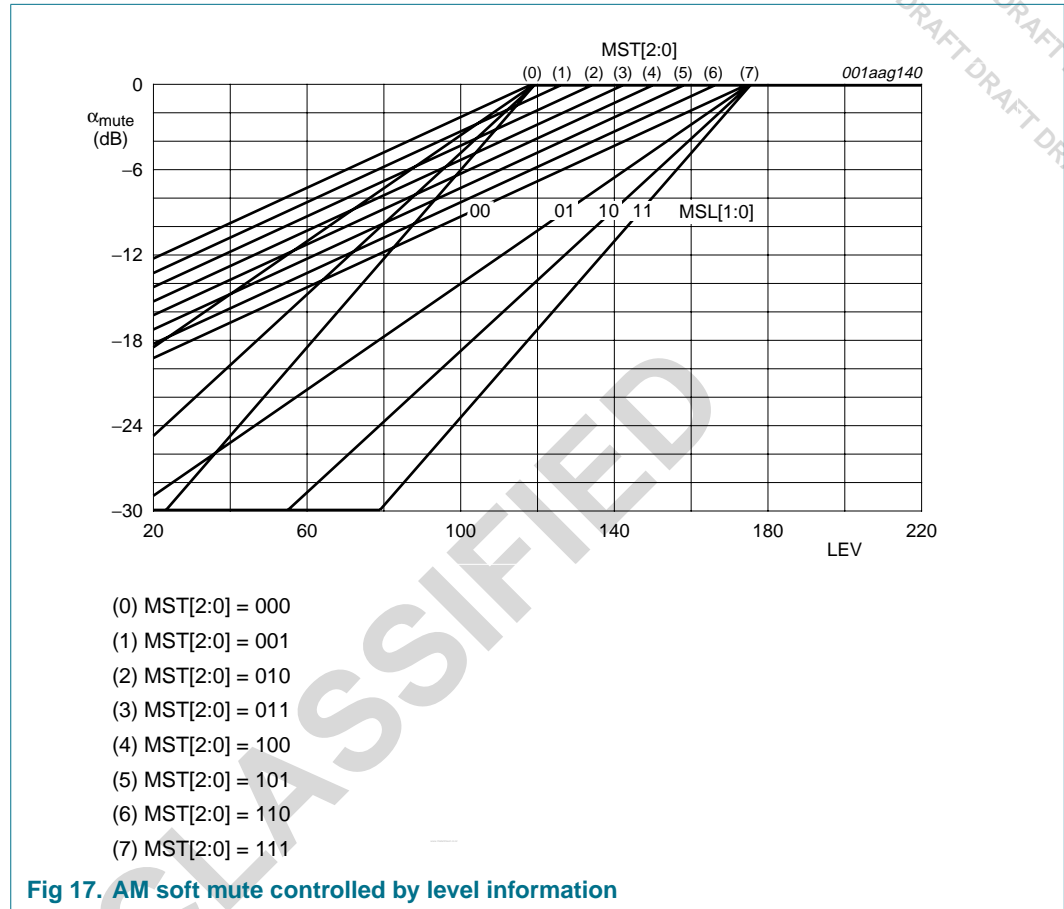

8.2.8 Write mode: data byte SOFTMUTE2_FM

Table 35. SOFTMUTE2_FM - data byte 6h bit allocation with default setting

7	6	5	4	3	2	1	0
MFON	MSON	MNS1	MNS0	MFOM	MSOM	MMS1	MMS0
0	0	0	0	0	0	0	0

Table 36. SOFTMUTE2_FM - data byte 6h bit description

Bit	Symbol	Description
7	MFON	soft mute fast on noise (USN) 0 = no fast control on noise (USN) 1 = fast control on noise (USN) active
6	MSON	soft mute slow on noise (USN) 0 = no slow control on noise (USN) 1 = slow control on noise (USN) active
5 and 4	MNS[1:0]	sensitivity of soft mute on noise (USN) 00 to 11 = weak to strong soft mute control by FM noise (USN); see Figure 18

Table 36. SOFTMUTE2_FM - data byte 6h bit description ...continued

Bit	Symbol	Description
3	MFOM	soft mute fast on multipath (WAM) 0 = no fast control on multipath (WAM) 1 = fast control on multipath (WAM) active
2	MSOM	soft mute slow on multipath (WAM) 0 = no slow control on multipath (WAM) 1 = slow control on multipath (WAM) active
1 and 0	MMS[1:0]	sensitivity of soft mute on multipath (WAM) 00 to 11 = weak to strong soft mute control by FM multipath (WAM); see Figure 19

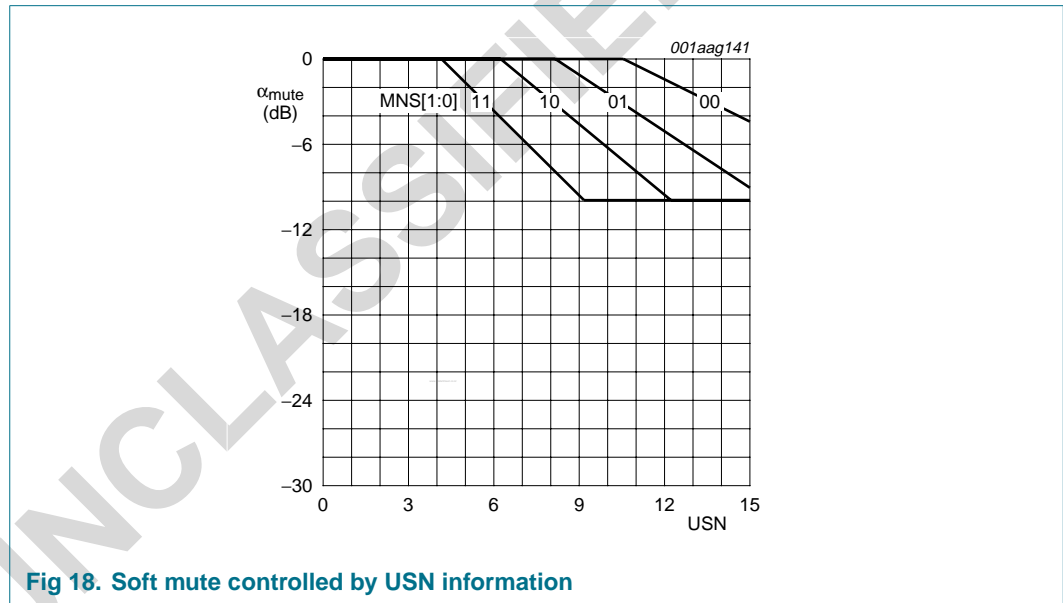

Fig 18. Soft mute controlled by USN information

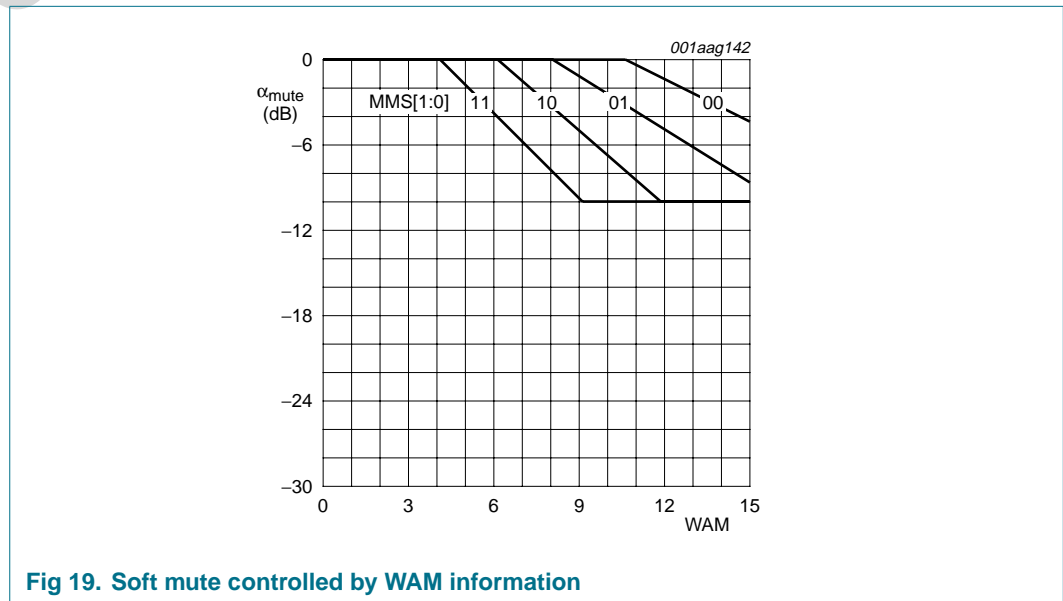

Fig 19. Soft mute controlled by WAM information

8.2.9 Write mode: data byte SOFTMUTE2_AM

Table 37. SOFTMUTE2_AM - data byte 6h bit allocation with default setting

7	6	5	4	3	2	1	0
0	0	0	MLIM4	MLIM3	MLIM2	MLIM1	MLIM0
			0	0	0	0	0

Table 38. SOFTMUTE2_AM - data byte 6h bit description

Bit	Symbol	Description
7 to 5	-	not used, must be set to logic 0
4 to 0	MLIM[4:0]	soft mute limit 0 0000 to 1 1110 = soft mute control limited at 0 dB to 30 dB; the soft mute control can be limited to the point at which natural soft mute starts

8.2.10 Write mode: data byte HIGHCUT0

Table 39. HIGHCUT0 - data byte 7h bit allocation with default setting

7	6	5	4	3	2	1	0
HMOD1	HMOD0	HLIM	HAT2	HAT1	HAT0	HRT1	HRT0
0	0	0	0	0	0	0	0

Table 40. HIGHCUT0 - data byte 7h bit description

Bit	Symbol	Description
7 and 6	HMOD[1:0]	high-cut on modulation; see Figure 20 00 = no modulation control 01 = high-cut (50 μs to 103 μs) for < 30 % modulation 10 = high-cut (50 μs to 103 μs) for < 50 % modulation 11 = high-cut (50 μs to 165 μs) for < 50 % modulation
5	HLIM	limitation of high-cut control on level, noise (USN) and multipath (WAM) 0 = high-cut limit at 165 μs, -10 dB at 10 kHz (for 50 μs de-emphasis) 1 = high-cut limit at 103 μs, -6 dB at 10 kHz (for 50 μs de-emphasis)
4 to 2	HAT[2:0]	high-cut slow attack time; see Table 41
1 and 0	HRT[1:0]	high-cut slow recovery time 00 = 2 times attack time 01 = 4 times attack time 10 = 8 times attack time 11 = 16 times attack time

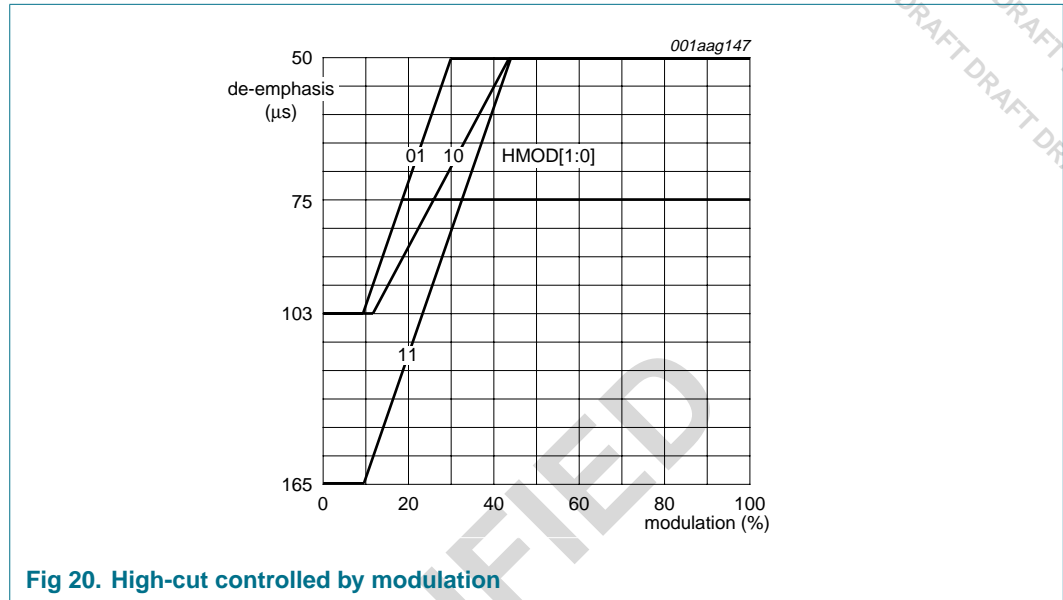

Fig 20. High-cut controlled by modulation

Table 41. High-cut attack time

HAT2	HAT1	HAT0	High-cut attack time
0	0	0	60 ms
0	0	1	125 ms
0	1	0	250 ms
0	1	1	0.5 s
1	0	0	1 s
1	0	1	2 s
1	1	0	4 s
1	1	1	8 s

8.2.11 Write mode: data byte HIGHCUT1

Table 42. HIGHCUT1 - data byte 8h bit allocation with default setting

7	6	5	4	3	2	1	0
HFOL	HSOL	0	HST2	HST1	HST0	HSL1	HSL0
0	0		0	0	0	0	0

Table 43. HIGHCUT1 - data byte 8h bit description

Bit	Symbol	Description
7	HFOL	high-cut fast on level 0 = no fast control on level 1 = fast control on level active
6	HSOL	high-cut slow on level 0 = no slow control on level 1 = slow control on level active
5	-	not used, must be set to logic 0

Table 43. HIGHCUT1 - data byte 8h bit description ...continued

Bit	Symbol	Description
4 to 2	HST[2:0]	high-cut start on level 000 to 111 = high threshold to low threshold of weak signal high-cut control; see Figure 21 and Figure 22
1 and 0	HSL[1:0]	high-cut slope on level 00 to 11 = low steepness to high steepness of slope of weak signal high-cut control; see Figure 21 and Figure 22

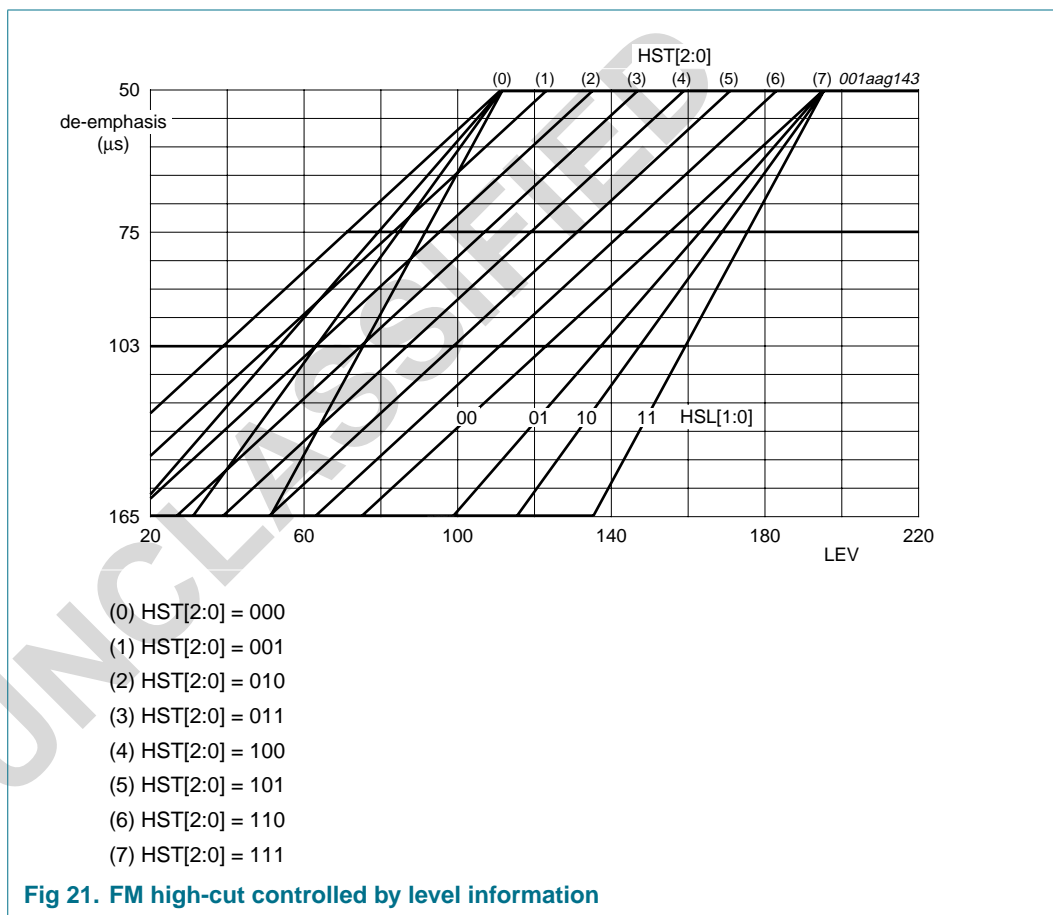

Fig 21. FM high-cut controlled by level information

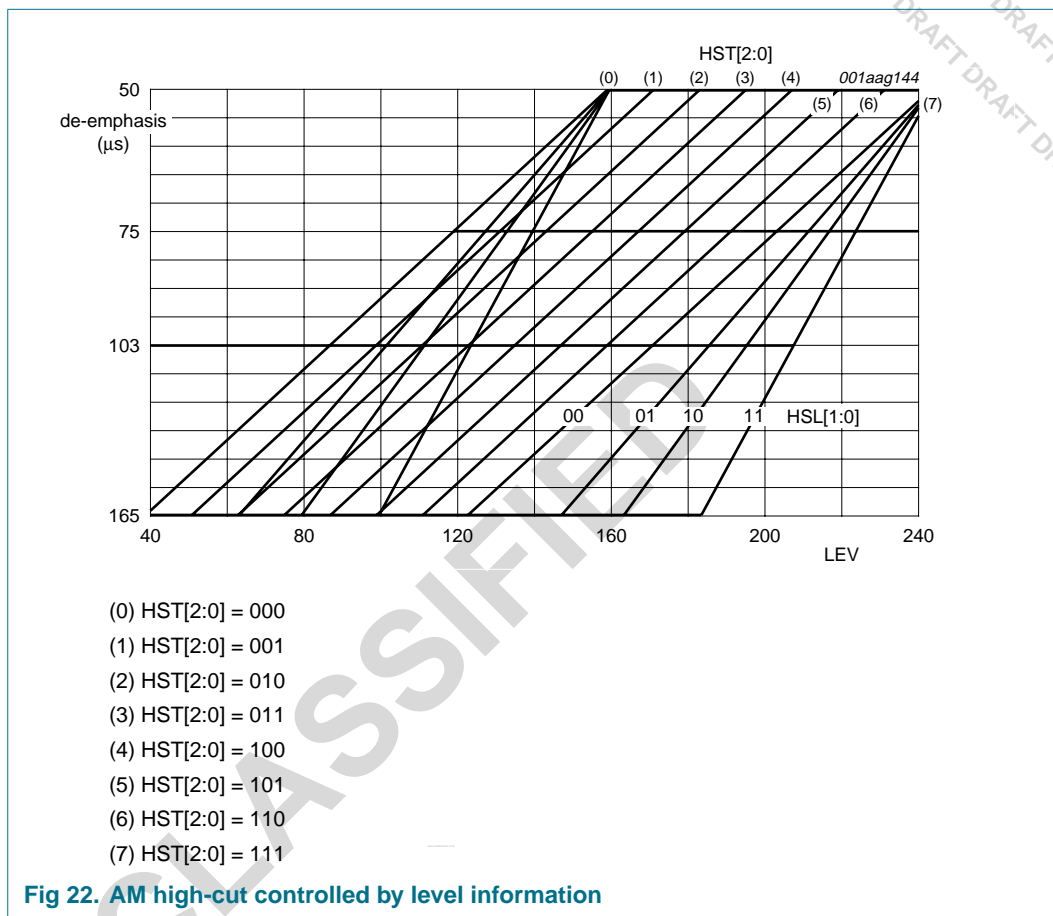

Fig 22. AM high-cut controlled by level information

8.2.12 Write mode: data byte HIGHCUT2

Table 44. HIGHCUT2 - data byte 9h bit allocation with default setting

7	6	5	4	3	2	1	0
HFON	HSO N	HNS1	HNS0	HFOM	HSOM	HMS1	HMS0
0	0	0	0	0	0	0	0

Table 45. HIGHCUT2 - data byte 9h bit description

Bit	Symbol	Description
7	HFON	high-cut fast on noise (USN) 0 = no fast control on noise (USN) 1 = fast control on noise (USN) active
6	HSO N	high-cut slow on noise (USN) 0 = no slow control on noise (USN) 1 = slow control on noise (USN) active
5 and 4	HNS[1:0]	sensitivity of high-cut on noise (USN) 00 to 11 = weak to strong high-cut control by FM noise (USN); see Figure 23

Table 45. HIGHCUT2 - data byte 9h bit description ...continued

Bit	Symbol	Description
3	HFOM	high-cut fast on multipath (WAM) 0 = no fast control on multipath (WAM) 1 = fast control on multipath (WAM) active
2	HSOM	high-cut slow on multipath (WAM) 0 = no slow control on multipath (WAM) 1 = slow control on multipath (WAM) active
1 and 0	HMS[1:0]	sensitivity of high-cut on multipath (WAM) 00 to 11 = weak to strong high-cut control by FM multipath (WAM); see Figure 24

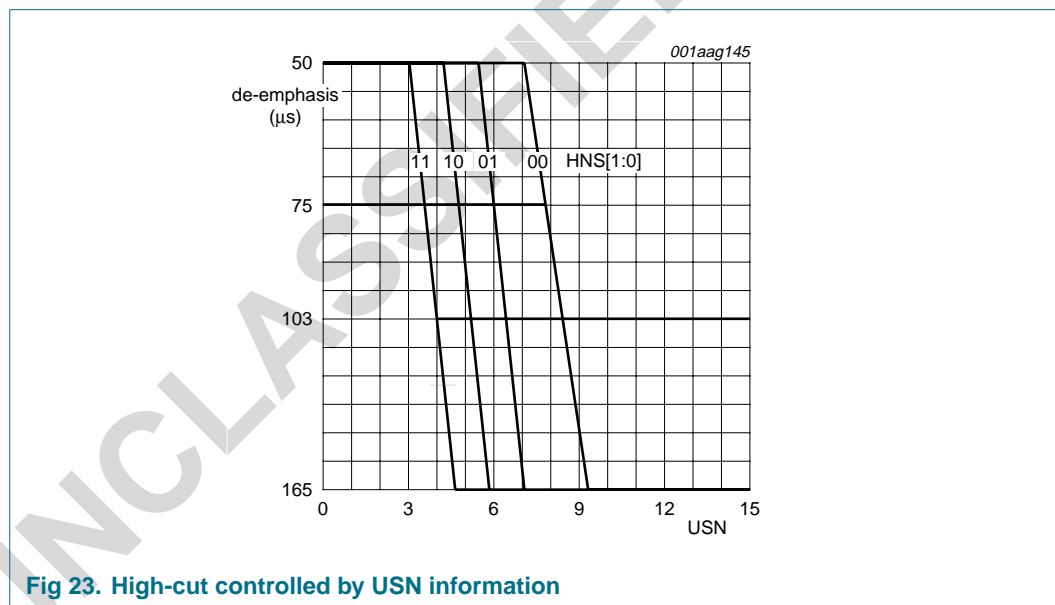

Fig 23. High-cut controlled by USN information

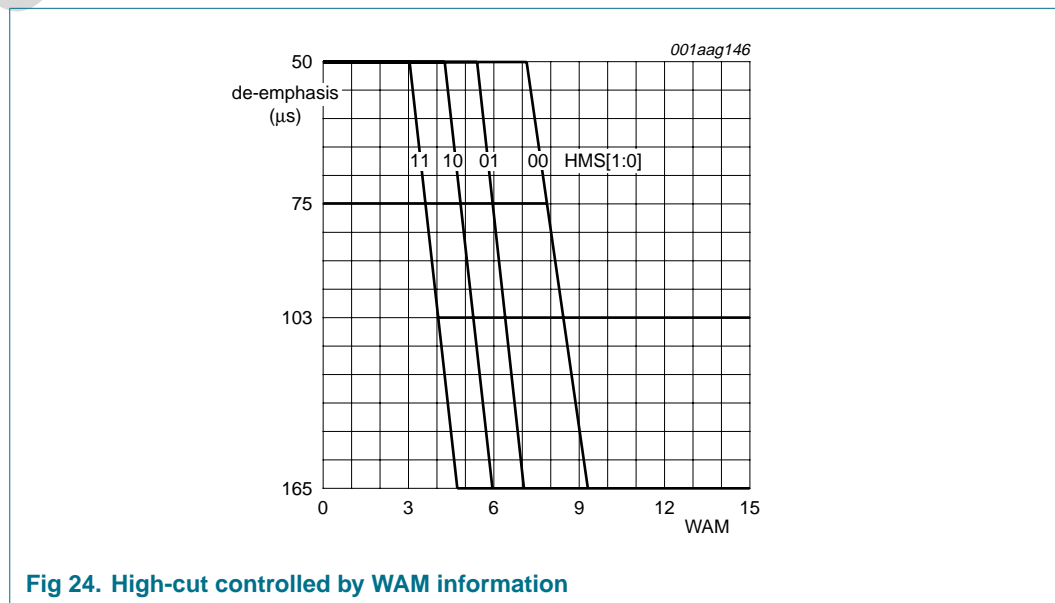

Fig 24. High-cut controlled by WAM information

8.2.13 Write mode: data byte STEREO0

Table 46. STEREO0 - data byte Ah bit allocation with default setting

7	6	5	4	3	2	1	0
SMOD1	SMOD0	0	SAT2	SAT1	SAT0	SRT1	SRT0
0	0		0	0	0	0	0

Table 47. STEREO0 - data byte Ah bit description

Bit	Symbol	Description
7 and 6	SMOD[1:0]	stereo blend on modulation; see Figure 25 00 = no modulation control 01 = stereo blend (stereo to mono) for < 30 % modulation 10 = stereo blend (stereo to 6 dB channel separation) for < 30 % modulation 11 = stereo blend (stereo to mono) for < 15 % modulation
5	-	not used, must be set to logic 0
4 to 2	SAT[2:0]	stereo blend slow attack time; see Table 48
1 and 0	SRT[1:0]	stereo blend slow recovery time 00 = 2 times attack time 01 = 4 times attack time 10 = 8 times attack time 11 = 16 times attack time

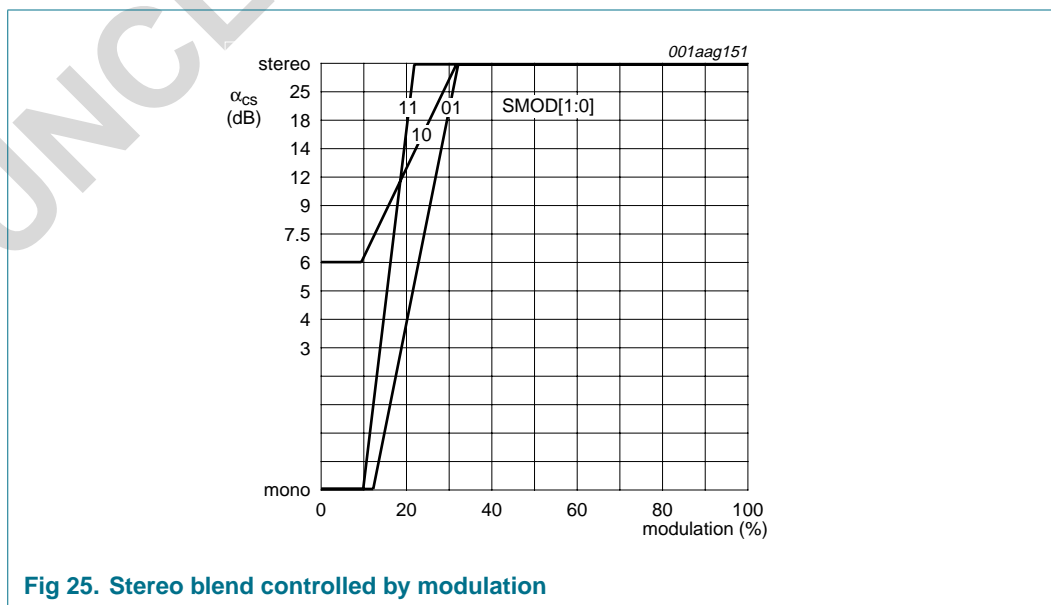

Fig 25. Stereo blend controlled by modulation

Table 48. Stereo blend attack time

SAT2	SAT1	SAT0	Stereo blend attack time
0	0	0	60 ms
0	0	1	125 ms
0	1	0	250 ms
0	1	1	0.5 s
1	0	0	1 s
1	0	1	2 s
1	1	0	4 s
1	1	1	8 s

8.2.14 Write mode: data byte STEREO1

Table 49. STEREO1 - data byte Bh bit allocation with default setting

7	6	5	4	3	2	1	0
SFOL	SSOL	0	SST2	SST1	SST0	SSL1	SSL0
0	0		0	0	0	0	0

Table 50. STEREO1 - data byte Bh bit description

Bit	Symbol	Description
7	SFOL	stereo blend fast on level 0 = no fast control on level 1 = fast control on level active
6	SSOL	stereo blend slow on level 0 = no slow control on level 1 = slow control on level active
5	-	not used, must be set to logic 0
4 to 2	SST[2:0]	stereo blend start on level 000 to 111 = high threshold to low threshold of weak signal stereo blend control; see Figure 26
1 and 0	SSL[1:0]	stereo blend slope on level 00 to 11 = low steepness to high steepness of slope of weak signal stereo blend control; see Figure 26

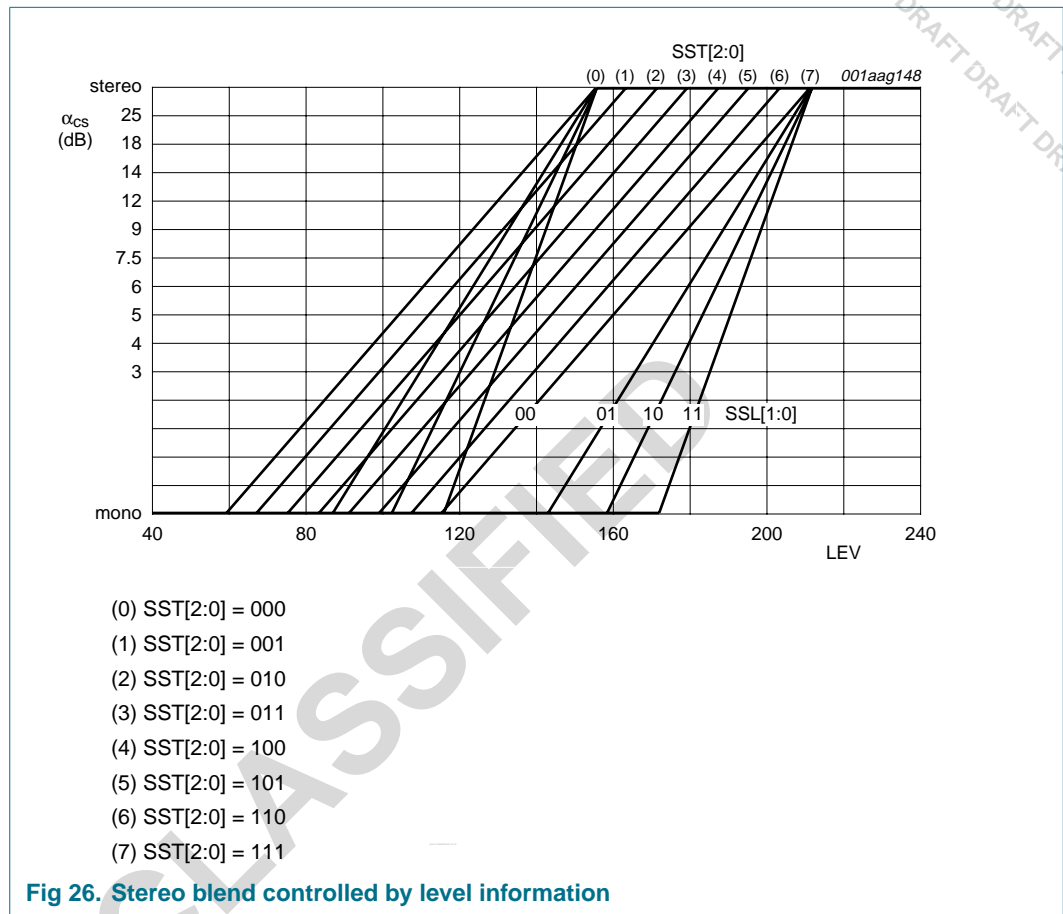

8.2.15 Write mode: data byte STEREO2

Table 51. STEREO2 - data byte Ch bit allocation with default setting

7	6	5	4	3	2	1	0
SFON	SSON	SNS1	SNS0	SFOM	SSOM	SMS1	SMS0
0	0	0	0	0	0	0	0

Table 52. STEREO2 - data byte Ch bit description

Bit	Symbol	Description
7	SFON	stereo blend fast on noise (USN) 0 = no fast control on noise (USN) 1 = fast control on noise (USN) active
6	SSON	stereo blend slow on noise (USN) 0 = no slow control on noise (USN) 1 = slow control on noise (USN) active
5 and 4	SNS[1:0]	sensitivity of stereo blend on noise (USN) 00 to 11 = weak to strong stereo blend control by FM noise (USN); see Figure 27

Table 52. STEREO2 - data byte Ch bit description ...continued

Bit	Symbol	Description
3	SFOM	stereo blend fast on multipath (WAM) 0 = no fast control on multipath (WAM) 1 = fast control on multipath (WAM) active
2	SSOM	stereo blend slow on multipath (WAM) 0 = no slow control on multipath (WAM) 1 = slow control on multipath (WAM) active
1 and 0	SMS[1:0]	sensitivity of stereo blend on multipath (WAM) 00 to 11 = weak to strong stereo blend control by FM multipath (WAM); see Figure 28

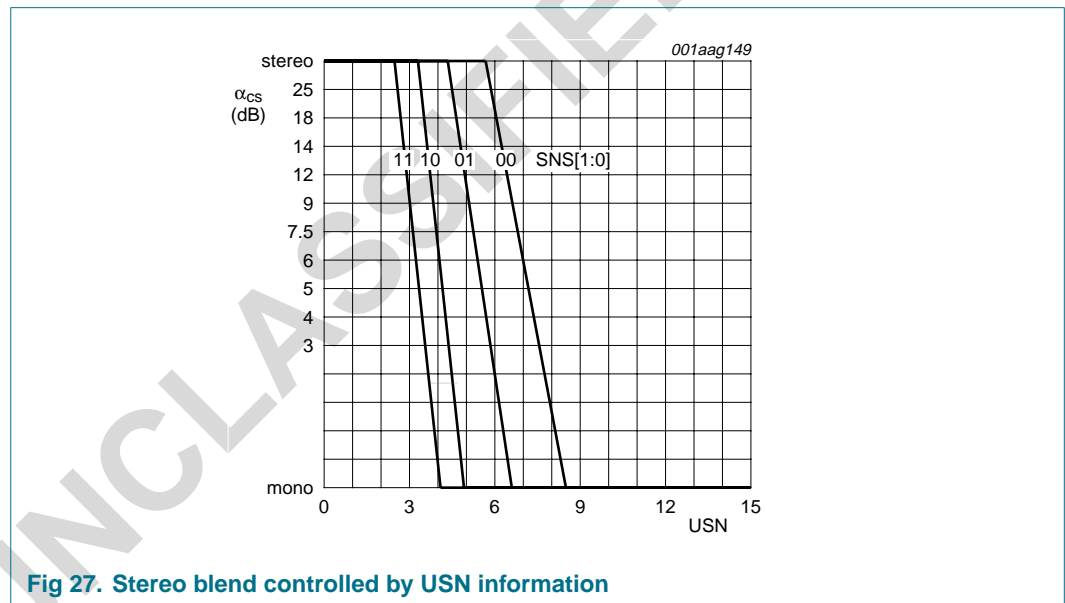

Fig 27. Stereo blend controlled by USN information

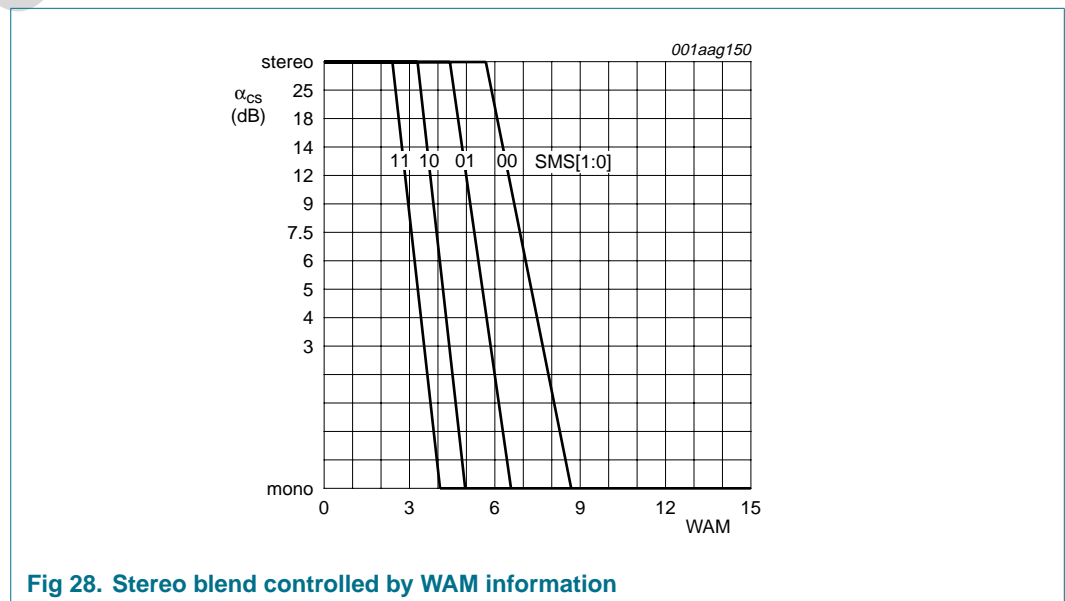

Fig 28. Stereo blend controlled by WAM information

8.2.16 Write mode: data byte CONTROL

Table 53. CONTROL - data byte Dh bit allocation with default setting

7	6	5	4	3	2	1	0
PORT	NBLIM	0	1	0	1	BWLEV	BWMOD
0	0					0	0

Table 54. CONTROL - data byte Dh bit description

Bit	Symbol	Description
7	PORT	switch output port 0 = pin TEST open-circuit 1 = pin TEST pull-down to ground
6	NBLIM	FM noise blanker pulse rate limiter 0 = pulse rate not limited 1 = pulse rate limited to 400 Hz
5	-	not used, must be set to logic 0
4	-	not used, must be set to logic 1
3	-	not used, must be set to logic 0
2	-	not used, must be set to logic 1
1	BWLEV	dynamic FM bandwidth control as a function of low level 0 = narrow bandwidth (reduced noise) 1 = wide bandwidth (modulation handling)
0	BWMOD	dynamic FM bandwidth control as a function of modulation 0 = adjacent channel suppression 1 = modulation handling

8.2.17 Write mode: data byte LEVEL_OFFSET

Table 55. LEVEL_OFFSET - data byte Eh bit allocation with default setting

7	6	5	4	3	2	1	0
0	LEVO6	LEVO5	LEVO4	LEVO3	LEVO2	LEVO1	LEVO0
	1	0	0	0	0	0	0

Table 56. LEVEL_OFFSET - data byte Eh bit description

Bit	Symbol	Description
7	-	not used, must be set to logic 0
6 to 0	LEVO[6:0]	level offset control ^[1] 0 to 127 = correction of the digital level information equivalent to a level voltage shift of -1 V to +1 V

[1] The level offset can be used to correct for active antenna gain and noise level. The level correction influences the weak signal processing and the LEVEL read data via I²C-bus. The level correction does not influence the analog voltage at pin RSSI.

8.2.18 Write mode: data byte AM_LNA

Table 57. AM_LNA - data byte Fh bit allocation with default setting

7	6	5	4	3	2	1	0
0	0	AAITT	ALAMT	0	CHSEP2	CHSEP1	CHSEP0
		0	1		1	0	0

Table 58. AM_LNA - data byte Fh bit description

Bit	Symbol	Description
7 and 6	-	not used, must be set to logic 0
5	AAITT	AM auto-injection test time 0 = 4 ms AM mirror measurement time at auto-injection tuning 1 = 8 ms AM mirror measurement time at auto-injection tuning
4	ALAMT	AM LNA AGC mute time; audio mute and fast AGC settling at AM LNA AGC step 0 = 4 ms 1 = 7 ms
3	-	not used, must be set to logic 0
2 to 0	CHSEP[2:0]	stereo channel separation alignment 100 = default setting (no alignment) 000 to 111 = optional channel separation

9. Limiting values

Table 59. Limiting values

In accordance with the Absolute Maximum Rating System (IEC 60134).

Symbol	Parameter	Conditions	Min	Max	Unit
V _{CC}	supply voltage	on pins V _{CC1} and V _{CC2}	-0.3	+10	V
ΔV _{CCn}	voltage difference between any supply pins	between pins V _{CC1} and V _{CC2}	-0.3	+0.3	V
V _{SCL}	voltage on pin SCL		-0.3	+6	V
V _{SDA}	voltage on pin SDA		-0.3	+6	V
V _{AMRFDEC}	voltage on pin AMRFDEC		-0.3	+6	V
V _{AMRFIN}	voltage on pin AMRFIN		-0.3	+6	V
V _{AMRFAGC}	voltage on pin AMRFAGC		-0.3	+6	V
V _{AMIFAGC2}	voltage on pin AMIFAGC2		-0.3	+6	V
V _{RSSI}	RSSI voltage		-0.3	+6	V
V _{VCODEC}	voltage on pin VCODEC		-0.3	+6	V
V _{PLL}	voltage on pin PLL		-0.3	+6	V
V _{PLLREF}	voltage on pin PLLREF		-0.3	+6	V
V _{TEST}	voltage on pin TEST		-0.3	+6	V
V _{AMIFAGC1}	voltage on pin AMIFAGC1		-0.3	+6	V
V _{VREF}	voltage on pin VREF		-0.3	+6	V
V _n	voltage on any other pin		-0.3	+V _{CC}	V
T _{stg}	storage temperature		-40	+150	°C

Table 59. Limiting values ...continued

In accordance with the Absolute Maximum Rating System (IEC 60134).

Symbol	Parameter	Conditions	Min	Max	Unit
T _{amb}	ambient temperature		[1] -40	+85	°C
T _{j(max)}	maximum junction temperature		-	150	°C
V _{esd}	electrostatic discharge voltage	human body model	[2] -2000	+2000	V
		machine model	[3] -200	+200	V

[1] For use of full operating supply voltage range and operating temperature range, the thermal resistance R_{th(j-a)} should be less than 54 K/W.

[2] Class 2 according to JESD22-A114D.

[3] Class B according to EIA/JESD22-A115-A.

10. Thermal characteristics

Table 60. Thermal characteristics

Symbol	Parameter	Conditions	Typ	Unit
R _{th(j-a)}	thermal resistance from junction to ambient	in free air	[1] 45	K/W

[1] Single layer board 70 mm by 100 mm with a copper thickness of 35 µm and a copper area coverage of 20 %.

11. Static characteristics

Table 61. Static characteristics

V_{CC} = 8.5 V; T_{amb} = 25 °C; unless otherwise specified.

Symbol	Parameter	Conditions	Min	Typ	Max	Unit
V _{CC}	supply voltage	on pins V _{CC1} and V _{CC2}	8	8.5	9	V
I _{CC}	supply current	into pins V _{CC1} , V _{CC2} and VREGSUP				
		FM	90	120	140	mA
		AM	100	134	150	mA
V _{VREGSUP}	voltage on pin VREGSUP	T _{amb} = -40 °C to +85 °C	6.35	-	-	V

Power-on reset

V _{P(POR)}	power-on reset supply voltage	reset at power-on	6.5	6.75	7.0	V
V _{hys(POR)}	power-on reset hysteresis voltage		-	0.2	-	V
t _{start}	start time	series resistance of crystal R _s = 150 Ω	-	10	100	ms

Logic pins SDA and SCL (voltage referenced to pin GNDD)

V _{IH}	HIGH-level input voltage	[1] 1.58	-	5.5	V
V _{IL}	LOW-level input voltage	[1] -0.5	-	+1.04	V

[1] SDA and SCL HIGH and LOW internal thresholds are specified according to an I²C-bus voltage of 2.5 V ± 10 % or 3.3 V ± 5 %. The I²C-bus interface tolerates also SDA and SCL signals from a 5 V I²C-bus, but does not fulfill the 5 V I²C-bus specification completely. The TEF6606 complies with the fast-mode I²C-bus protocol. The maximum I²C-bus communication speed is 400 kbit/s.

12. Dynamic characteristics

Table 62. Dynamic characteristics

$V_{CC} = 8.5\text{ V}$; $T_{amb} = 25\text{ }^\circ\text{C}$; unless otherwise specified.

FM condition: all RF voltages refer to an unterminated RMS voltage with a source impedance $75\ \Omega$; $f_{mod} = 1\text{ kHz}$, $\Delta f = 22.5\text{ kHz}$, de-emphasis = $50\ \mu\text{s}$, $f_{RF} = 97.1\text{ MHz}$; unless otherwise specified.

AM condition: all RF voltages are RMS values measured at the input of a $15\text{ pF} / 60\text{ pF}$ dummy aerial; $f_{mod} = 400\text{ Hz}$, $m = 30\%$, $f_{RF} = 990\text{ kHz}$; unless otherwise specified.

All values measured in a test circuit according to [Figure 30](#); default settings; audio signals measured at LOUT and ROUT with IEC tuner filter (200 Hz to 15 kHz; IEC 60315-4); unless otherwise specified.

Symbol	Parameter	Conditions	Min	Typ	Max	Unit
Crystal oscillator; pins XTAL1 and XTAL2						
f_{xtal}	crystal frequency	fundamental frequency	-	4	-	MHz
Δf_{xtal}	inaccuracy caused by device		-45	-0	45	ppm
C_i	input capacitance	input capacitance from XTAL1 and XTAL2 to ground	1	3	4	pF
R_i	input resistance		-	-	-750	Ω
Tuning system						
C/N	LO carrier-to-noise ratio	$f_{LO} = 100\text{ MHz}$; $\Delta f = 10\text{ kHz}$	-	98	-	dBc/ $\sqrt{\text{Hz}}$
t_{tune}	tuning time	FM (Europe/USA/Japan) $f_{RF} = 87.5\text{ MHz to }108\text{ MHz}$	-	1.8	2	ms
		FM (OIRT) $f_{RF} = 65\text{ MHz to }74\text{ MHz}$	-	6.8	7	ms
		AM (MW) $f_{RF} = 0.53\text{ MHz to }1.7\text{ MHz}$	-	9	9.2	ms
		AM (LW) $f_{RF} = 0.144\text{ MHz to }0.288\text{ MHz}$	-	3.5	3.7	ms
		AM (SW) $f_{RF} = 2.94\text{ MHz to }18.135\text{ MHz}$	-	3.5	3.7	ms
f_{RF}	RF frequency	FM tuning range	65	-	108	MHz
		AM (LW) tuning range	144	-	288	kHz
		AM (MW) tuning range	522	-	1710	kHz
		AM (SW) tuning range	2.94	-	18.135	MHz
$f_{tune(step)}$	step of tuning frequency	FM (Europe/USA/Japan)	-	50	-	kHz
		FM (OIRT)	-	10	-	kHz
		AM (LW and MW)	-	1	-	kHz
		AM (SW)	-	5	-	kHz
FM path						
$V_{i(sens)}$	input sensitivity voltage	(S+N)/N = 26 dB; without weak signal handling	-	5.5	-	dB μV
		(S+N)/N = 26 dB; including weak signal handling	-	5	-	dB μV
		(S+N)/N = 46 dB; including weak signal handling	-	16	-	dB μV
NF	noise figure		-	6	9	dB
$V_{L(LO)}$	LO leakage voltage	LO residue at antenna input; $R_{source(ant)} = 75\ \Omega$	1	-6	-	dB μV

Table 62. Dynamic characteristics ...continued

$V_{CC} = 8.5\text{ V}$; $T_{amb} = 25\text{ }^{\circ}\text{C}$; unless otherwise specified.

FM condition: all RF voltages refer to an unterminated RMS voltage with a source impedance $75\text{ }\Omega$; $f_{mod} = 1\text{ kHz}$, $\Delta f = 22.5\text{ kHz}$, de-emphasis = $50\text{ }\mu\text{s}$, $f_{RF} = 97.1\text{ MHz}$; unless otherwise specified.

AM condition: all RF voltages are RMS values measured at the input of a $15\text{ pF} / 60\text{ pF}$ dummy aerial; $f_{mod} = 400\text{ Hz}$, $m = 30\%$, $f_{RF} = 990\text{ kHz}$; unless otherwise specified.

All values measured in a test circuit according to [Figure 30](#); default settings; audio signals measured at LOUT and ROUT with IEC tuner filter (200 Hz to 15 kHz; IEC 60315-4); unless otherwise specified.

Symbol	Parameter	Conditions	Min	Typ	Max	Unit
$V_{sp(VCO)}$	VCO spurious voltage	VCO residue at antenna input; $R_{source(ant)} = 75\text{ }\Omega$	-	46	60	$\text{dB}\mu\text{V}$
(S+N)/N	signal plus noise-to-noise ratio	$V_{i(RF)} = 1\text{ mV}$; $\Delta f = 22.5\text{ kHz}$	55	60	-	dB
α_{ripple}	ripple rejection	V_{ripple} / V_{audio} ; $V_{ripple} = 100\text{ mV}$; $f_{ripple} = 100\text{ Hz}$	34	44	-	dB
f_{IF}	IF frequency		-	150	-	kHz
α_{image}	image rejection	$f_{RF(image)} = f_{RF(wanted)} \pm 2 \times f_{IF}$	50	60	-	dB
IP3	third-order intercept point	$f_{RF(unw)1} = 97.5\text{ MHz}$; $f_{RF(unw)2} = 97.9\text{ MHz}$; $V_{i(RF)} = 80\text{ dB}\mu\text{V}$	106	113	-	$\text{dB}\mu\text{V}$
S_{dyn}	dynamic selectivity	$V_{i(RF)} = 10\text{ }\mu\text{V}$; $\Delta f_{RF(unw)} = 22.5\text{ kHz}$; (S+N)/N = 26 dB; mono; $f_{AF} = 1\text{ kHz}$				
		$\Delta f_{RF} = 100\text{ kHz}$; PACS disabled	-	3	-	dB
		$\Delta f_{RF} = 200\text{ kHz}$; PACS disabled	-	55	-	dB
		$\Delta f_{RF} = 100\text{ kHz}$; PACS enabled	-	24	-	dB
		$\Delta f_{RF} = 200\text{ kHz}$; PACS enabled	-	64	-	dB
S_{stat}	static selectivity	maximum IF bandwidth; $f_{i(RF)} \pm 100\text{ kHz}$	10	14	25	dB
		maximum IF bandwidth; $f_{i(RF)} \pm 200\text{ kHz}$	54	64	74	dB
		maximum IF bandwidth; $f_{i(RF)} \pm 300\text{ kHz}$ (excluding image)	65	75	90	dB
		minimum IF bandwidth; $f_{i(RF)} \pm 100\text{ kHz}$	30	38	-	dB
		minimum IF bandwidth; $f_{i(RF)} \pm 200\text{ kHz}$	63	73	-	dB
$\alpha_{sup(AM)}$	AM suppression	AM: $f_{AF} = 1\text{ kHz}$; $m = 30\%$				
		$V_{i(RF)} = 0.05\text{ mV}$ to 20 mV	45	55	-	dB
		$V_{i(RF)} = 20\text{ mV}$ to 500 mV	40	50	-	dB
$V_{start(desens)}$	desensitization start voltage	unwanted signal voltage for 6 dB desensitization; $ f_{RF(unw)} - f_{RF(wanted)} > 400\text{ kHz}$; $V_{i(RF)wanted} = 30\text{ dB}\mu\text{V}$; data byte 2h bits RFAGC[1:0] = 00	-	90	-	$\text{dB}\mu\text{V}$
V_{sp}	spurious voltage	at antenna input; $R_{source(ant)} = 75\text{ }\Omega$				
		$30\text{ MHz} < f < 1\text{ GHz}$	-	-	50	$\text{dB}\mu\text{V}$
		$1\text{ GHz} < f < 12.75\text{ GHz}$	-	-	60	$\text{dB}\mu\text{V}$

Table 62. Dynamic characteristics ...continued

$V_{CC} = 8.5\text{ V}$; $T_{amb} = 25\text{ °C}$; unless otherwise specified.

FM condition: all RF voltages refer to an unterminated RMS voltage with a source impedance $75\ \Omega$; $f_{mod} = 1\text{ kHz}$, $\Delta f = 22.5\text{ kHz}$, de-emphasis = $50\ \mu\text{s}$, $f_{RF} = 97.1\text{ MHz}$; unless otherwise specified.

AM condition: all RF voltages are RMS values measured at the input of a $15\text{ pF} / 60\text{ pF}$ dummy aerial; $f_{mod} = 400\text{ Hz}$, $m = 30\%$, $f_{RF} = 990\text{ kHz}$; unless otherwise specified.

All values measured in a test circuit according to [Figure 30](#); default settings; audio signals measured at LOUT and ROUT with IEC tuner filter (200 Hz to 15 kHz; IEC 60315-4); unless otherwise specified.

Symbol	Parameter	Conditions	Min	Typ	Max	Unit
FM front-end; pins FMIN1 and FMIN2						
$R_{i(dif)}$	differential input resistance	$f_{RF} = 97.1\text{ MHz}$; maximum gain	200	300	400	Ω
$C_{i(dif)}$	differential input capacitance	$f_{RF} = 97.1\text{ MHz}$	-	4	7	pF
FM RF AGC						
$V_{start(AGC)}$	AGC start voltage	RF input voltage for first AGC step; $V_{i(RF)}$ value, at which the RF gain decreases by 6 dB with increasing $V_{i(RF)}$; data byte 2h				
		bits RFAGC[1:0] = 00	77	80	83	$\text{dB}\mu\text{V}$
		bits RFAGC[1:0] = 01	79	82	85	$\text{dB}\mu\text{V}$
		bits RFAGC[1:0] = 10	81	84	87	$\text{dB}\mu\text{V}$
		bits RFAGC[1:0] = 11	83	86	89	$\text{dB}\mu\text{V}$
$V_{i(RF)AGC(hys)}$	hysteresis of AGC RF input voltage	hysteresis of AGC start	1	-	5	dB
FM IF AGC						
$V_{i(RF)AGC}$	AGC RF input voltage	$V_{i(RF)}$ value, at which the IF gain decreases by 6 dB with increasing $V_{i(RF)}$; start of AGC; first step	71	76	81	$\text{dB}\mu\text{V}$
$V_{i(RF)AGC(hys)}$	hysteresis of AGC RF input voltage	hysteresis of AGC start	1	-	6	dB
FM RSSI; pin RSSI						
V_{RSSI}	RSSI voltage	$V_{i(RF)} = -20\text{ dB}\mu\text{V}$	0.65	0.8	0.95	V
		$V_{i(RF)} = 20\text{ dB}\mu\text{V}$	1.8	2.0	2.2	V
		$V_{i(RF)} = 40\text{ dB}\mu\text{V}$	2.75	3.0	3.25	V
		$V_{i(RF)} = 60\text{ dB}\mu\text{V}$	3.6	3.9	4.2	V
$\Delta V_{RSSI}/\Delta L_{i(RF)}$	RSSI voltage difference to RF input level difference ratio	between $V_{i(RF)} = 20\text{ dB}\mu\text{V}$ and $V_{i(RF)} = 40\text{ dB}\mu\text{V}$	45	50	55	mV/dB
$f_{-3dB(RSSI)}$	RSSI cut-off frequency	$V_{i(RF)} = 500\ \mu\text{V}$; $m = 30\%$	100	-	-	kHz
FM IF counter						
$V_{i(sens)}$	input sensitivity voltage	$V_{i(RF)}$ at which IF counter starts; $\Delta f = 0\text{ Hz}$	-	2	5	μV
$f_{IFc(res)}$	IF counter frequency resolution		-	5	-	kHz
FM demodulator; pin MPXOUT						
R_o	output resistance		-	-	100	Ω
R_L	load resistance		5	-	-	$\text{k}\Omega$
C_L	load capacitance		-	-	20	pF
Δf_{max}	maximum frequency deviation	THD = 3 %; $V_{i(RF)} = 10\text{ mV}$	115	140	-	kHz
V_o	output voltage	$\Delta f = 22.5\text{ kHz}$; $f_{AF} = 1\text{ kHz}$	180	230	300	mV

Table 62. Dynamic characteristics ...continued

$V_{CC} = 8.5\text{ V}$; $T_{amb} = 25\text{ °C}$; unless otherwise specified.

FM condition: all RF voltages refer to an unterminated RMS voltage with a source impedance $75\ \Omega$; $f_{mod} = 1\text{ kHz}$, $\Delta f = 22.5\text{ kHz}$, de-emphasis = $50\ \mu\text{s}$, $f_{RF} = 97.1\text{ MHz}$; unless otherwise specified.

AM condition: all RF voltages are RMS values measured at the input of a $15\text{ pF} / 60\text{ pF}$ dummy aerial; $f_{mod} = 400\text{ Hz}$, $m = 30\%$, $f_{RF} = 990\text{ kHz}$; unless otherwise specified.

All values measured in a test circuit according to [Figure 30](#); default settings; audio signals measured at LOUT and ROUT with IEC tuner filter (200 Hz to 15 kHz; IEC 60315-4); unless otherwise specified.

Symbol	Parameter	Conditions	Min	Typ	Max	Unit
Audio part; pin MPXIN						
R_i	input resistance	data byte 3h bit LOCUT = 0 (FM or AM)	-	220	-	k Ω
		data byte 3h bit LOCUT = 1 (AM)	-	16	-	k Ω
$\alpha_{bal(ch)}$	channel balance	balance between R and L channel	-1	-	+1	dB
$\alpha_{sup(pilot)}$	pilot suppression	9 % pilot; $f_{pilot} = 19\text{ kHz}$; referenced to 91 % FM modulation	30	40	-	dB
m_{pilot}	modulation degree of pilot tone	threshold for pilot detection				
		stereo on	2	3.9	5.8	%
		stereo off	1.2	3.1	5	%
$\alpha_{hys(pilot)}$	pilot hysteresis		0.7	0.8	1.6	%
$t_{det(pilot)}$	pilot detection time		-	30	100	ms
Audio output; pins LOUT and ROUT						
V_o	output voltage	$\Delta f = 22.5\text{ kHz}$; $f_{AF} = 1\text{ kHz}$				
		data byte 3h bit OUTA = 1	200	290	410	mV
		data byte 3h bit OUTA = 0	80	120	175	mV
α_{AF}	AF attenuation	mono; pre-emphasis = $50\ \mu\text{s}$; referenced to $f_{AF} = 1\text{ kHz}$				
		$f_{AF} = 50\text{ Hz}$	-0.6	-0.1	+0.4	dB
		$f_{AF} = 15\text{ kHz}$	-1.5	0	+1.5	dB
α_{cs}	channel separation	$V_{i(RF)} = 1\text{ mV}$; data byte Fh bits CHSEP[2:0] = 100	26	40	-	dB
THD	total harmonic distortion	mono; $\Delta f = 75\text{ kHz}$; $V_{i(RF)} = 1\text{ mV}$	-	0.4	0.8	%
		stereo; $\Delta f = 67.5\text{ kHz}$; L or R	-	-	1	%
R_L	load resistance		10	-	-	k Ω
C_L	load capacitance		-	-	20	pF
FM noise blanker						
(S+N)/N	signal plus noise-to-noise ratio	noise pulses at RF input signal $t_p = 5\text{ ns}$; $t_r < 1\text{ ns}$; $t_f < 1\text{ ns}$; $f_p = 100\text{ Hz}$; $V_p = 500\text{ mV}$; $V_{i(RF)} = 40\text{ dB}\mu\text{V}$; quasi peak; audio filter according "ITU-R BS.468-4"	-	30	-	dB
AM path						
$V_{i(sens)}$	input sensitivity voltage	S/N = 26 dB; data byte 3h bits DEMP[1:0] = 10; MW	-	34	-	dB μV
$V_{n(i)(eq)}$	equivalent input noise voltage	$C_{source} = 100\text{ pF}$	-	1	-	nV/ $\sqrt{\text{Hz}}$
(S+N)/N	signal plus noise-to-noise ratio	$V_{i(RF)} = 10\text{ mV}$	50	56	-	dB

Table 62. Dynamic characteristics ...continued

$V_{CC} = 8.5\text{ V}$; $T_{amb} = 25\text{ }^{\circ}\text{C}$; unless otherwise specified.

FM condition: all RF voltages refer to an unterminated RMS voltage with a source impedance $75\text{ }\Omega$; $f_{mod} = 1\text{ kHz}$, $\Delta f = 22.5\text{ kHz}$, de-emphasis = $50\text{ }\mu\text{s}$, $f_{RF} = 97.1\text{ MHz}$; unless otherwise specified.

AM condition: all RF voltages are RMS values measured at the input of a $15\text{ pF} / 60\text{ pF}$ dummy aerial; $f_{mod} = 400\text{ Hz}$, $m = 30\%$, $f_{RF} = 990\text{ kHz}$; unless otherwise specified.

All values measured in a test circuit according to [Figure 30](#); default settings; audio signals measured at LOUT and ROUT with IEC tuner filter (200 Hz to 15 kHz; IEC 60315-4); unless otherwise specified.

Symbol	Parameter	Conditions	Min	Typ	Max	Unit
f_{IF}	IF frequency		-	25	-	kHz
α_{image}	image rejection	$f_{RF(image)} = f_{RF(wanted)} \pm 2 \times f_{IF}$	45	55	-	dB
$\alpha_{sup(H)LO}$	LO harmonics suppression	$f_{RF(unw)} = N \times (f_{RF(wanted)} \pm f_{IF}) \pm f_{IF}$; MW				
		$N = 2, 3, 4, 5, 6$	-	90	-	dB
		$N \geq 7$	-	50	-	dB
$V_{L(LO)}$	LO leakage voltage	LO residue at antenna input; load capacitance at antenna input; $C_{ant} = 60\text{ pF}$	-	-6	-	$\text{dB}\mu\text{V}$
$B_{filtr(IF)}$	IF filter bandwidth	-3 dB bandwidth	5	6.5	8	kHz
S_{stat}	static selectivity	$f_{tune} \pm 10\text{ kHz}$	40	48	-	dB
		$f_{tune} \pm 20\text{ kHz}$	65	78	-	dB
$V_{i(RF)(max)}$	maximum RF input voltage	THD = 10 %; $m = 80\%$; active antenna $50\text{ }\Omega$	120	135	-	$\text{dB}\mu\text{V}$
IP2	second-order intercept point		150	170	-	$\text{dB}\mu\text{V}$
IP3	third-order intercept point	$\Delta f = 40\text{ kHz}$	116	127	-	$\text{dB}\mu\text{V}$

AM LNA and AM RF AGC; input pins AMRFIN and AMRFDEC

R_i	input resistance	$f_{RF} = 990\text{ kHz}$	-	20	-	Ω
C_i	input capacitance	AGC maximum gain	[2][3]	530	-	pF

MW band with passive antenna (measured with dummy aerial 15 pF / 60 pF)

$V_{i(RF)AGC}$	AGC RF input voltage	switched LNA AGC: $V_{i(RF)}$ value, at which the LNA gain decreases with increasing $V_{i(RF)}$; $m = 0\%$; start of AGC; first step	110	113	116	$\text{dB}\mu\text{V}$
$V_{i(RF)AGC(hys)}$	hysteresis of AGC RF input voltage	hysteresis of AGC start	1	3	6	dB

MW band with active antenna (measured with dummy aerial 50 Ω)

$V_{i(RF)AGC}$	AGC RF input voltage	switched LNA AGC: $V_{i(RF)}$ value, at which the LNA gain decreases with increasing $V_{i(RF)}$; $m = 0\%$; start of AGC; first step	78	81	84	$\text{dB}\mu\text{V}$
$V_{i(RF)AGC(hys)}$	hysteresis of AGC RF input voltage	hysteresis of AGC start	1	3	6	dB

LW band with passive antenna (measured with dummy aerial 15 pF / 60 pF)

$V_{i(RF)AGC}$	AGC RF input voltage	switched LNA AGC: $V_{i(RF)}$ value, at which the LNA gain decreases with increasing $V_{i(RF)}$; $f_{RF} = 207\text{ kHz}$; $m = 0\%$; start of AGC; first step	-	104	-	$\text{dB}\mu\text{V}$
----------------	----------------------	---	---	-----	---	------------------------

Table 62. Dynamic characteristics ...continued

$V_{CC} = 8.5\text{ V}$; $T_{amb} = 25\text{ °C}$; unless otherwise specified.

FM condition: all RF voltages refer to an unterminated RMS voltage with a source impedance $75\ \Omega$; $f_{mod} = 1\text{ kHz}$, $\Delta f = 22.5\text{ kHz}$, de-emphasis = $50\ \mu\text{s}$, $f_{RF} = 97.1\text{ MHz}$; unless otherwise specified.

AM condition: all RF voltages are RMS values measured at the input of a $15\text{ pF} / 60\text{ pF}$ dummy aerial; $f_{mod} = 400\text{ Hz}$, $m = 30\%$, $f_{RF} = 990\text{ kHz}$; unless otherwise specified.

All values measured in a test circuit according to [Figure 30](#); default settings; audio signals measured at LOUT and ROUT with IEC tuner filter (200 Hz to 15 kHz; IEC 60315-4); unless otherwise specified.

Symbol	Parameter	Conditions	Min	Typ	Max	Unit
$V_{i(RF)AGC(hys)}$	hysteresis of AGC RF input voltage	hysteresis of AGC start	1	3	6	dB
<i>LW band with active antenna (measured with dummy aerial $50\ \Omega$)</i>						
$V_{i(RF)AGC}$	AGC RF input voltage	switched LNA AGC: $V_{i(RF)}$ value, at which the LNA gain decreases with increasing $V_{i(RF)}$; $f_{RF} = 207\text{ kHz}$; $m = 0\%$; start of AGC; first step	-	72	-	$\text{dB}\mu\text{V}$
$V_{i(RF)AGC(hys)}$	hysteresis of AGC RF input voltage	hysteresis of AGC start	1	3	6	dB
<i>SW bands with passive antenna (measured with dummy aerial $15\text{ pF} / 60\text{ pF}$)</i>						
$V_{i(RF)AGC}$	AGC RF input voltage	switched LNA AGC: $V_{i(RF)}$ value, at which the LNA gain decreases with increasing $V_{i(RF)}$; $f_{RF} = 6.1\text{ MHz}$; $m = 0\%$; start of AGC; first step	-	101	-	$\text{dB}\mu\text{V}$
$V_{i(RF)AGC(hys)}$	hysteresis of AGC RF input voltage	hysteresis of AGC start	1	3	6	dB
<i>SW bands with active antenna (measured with dummy aerial $50\ \Omega$)</i>						
$V_{i(RF)AGC}$	AGC RF input voltage	switched LNA AGC: $V_{i(RF)}$ value, at which the LNA gain decreases with increasing $V_{i(RF)}$; $f_{RF} = 6.1\text{ MHz}$; $m = 0\%$; start of AGC; first step	-	80	-	$\text{dB}\mu\text{V}$
$V_{i(RF)AGC(hys)}$	hysteresis of AGC RF input voltage	hysteresis of AGC start	1	3	6	dB
Continuous AM RF AGC						
$V_{i(RF)AGC}$	AGC RF input voltage	linear RF AGC: $V_{i(RF)}$ at which AGC starts; $m = 0\%$				
		data byte 2h bits RFAGC[1:0] = 00	87	90	93	$\text{dB}\mu\text{V}$
		data byte 2h bits RFAGC[1:0] = 01	85	88	91	$\text{dB}\mu\text{V}$
		data byte 2h bits RFAGC[1:0] = 10	83	86	89	$\text{dB}\mu\text{V}$
		data byte 2h bits RFAGC[1:0] = 11	81	84	87	$\text{dB}\mu\text{V}$
t_s	settling time	$V_{i(RF)} = 10\text{ mV to }600\text{ mV}$	-	64	-	ms
		$V_{i(RF)} = 600\text{ mV to }10\text{ mV}$	-	3.2	-	s

Table 62. Dynamic characteristics ...continued

$V_{CC} = 8.5\text{ V}$; $T_{amb} = 25\text{ °C}$; unless otherwise specified.

FM condition: all RF voltages refer to an unterminated RMS voltage with a source impedance $75\ \Omega$; $f_{mod} = 1\text{ kHz}$, $\Delta f = 22.5\text{ kHz}$, de-emphasis = $50\ \mu\text{s}$, $f_{RF} = 97.1\text{ MHz}$; unless otherwise specified.

AM condition: all RF voltages are RMS values measured at the input of a $15\text{ pF} / 60\text{ pF}$ dummy aerial; $f_{mod} = 400\text{ Hz}$, $m = 30\%$, $f_{RF} = 990\text{ kHz}$; unless otherwise specified.

All values measured in a test circuit according to [Figure 30](#); default settings; audio signals measured at LOUT and ROUT with IEC tuner filter (200 Hz to 15 kHz; IEC 60315-4); unless otherwise specified.

Symbol	Parameter	Conditions	Min	Typ	Max	Unit
$I_{source(AGC)}$	AGC source current	AGC attack; $V_{i(RF)M} = 105\text{ dB}\mu\text{V}$ (peak); normal mode	25	35	50	μA
		AGC attack; fast mode after tuning and AGC switching	0.7	1	1.4	mA
$I_{sink(AGC)}$	AGC sink current	AGC release; normal mode	0.7	1	1.4	μA
		AGC release; fast mode after tuning and AGC switching	17.5	25	35	μA
Continuous IF AGC 1						
$V_{i(RF)AGC}$	AGC RF input voltage	linear IF AGC 1: $V_{i(RF)}$ at which AGC starts; $m = 0\%$	59	62	65	$\text{dB}\mu\text{V}$
$I_{source(AGC)}$	AGC source current	AGC attack; $V_{i(RF)M} = 80\text{ dB}\mu\text{V}$ (peak); normal mode	35	50	70	μA
		AGC attack; fast mode after tuning and AGC switching	0.875	1.25	1.75	mA
$I_{sink(AGC)}$	AGC sink current	AGC release; normal mode	0.7	1	1.4	μA
		AGC release; fast mode after tuning and AGC switching	17.5	25	35	μA
Continuous IF AGC 2						
$V_{i(RF)AGC}$	AGC RF input voltage	linear IF AGC 2: $V_{i(RF)}$ at which AGC starts; $m = 0\%$	19	22	25	$\text{dB}\mu\text{V}$
$I_{source(AGC)}$	AGC source current	AGC attack; $V_{i(RF)M} = 50\text{ dB}\mu\text{V}$ (peak); normal mode	4	6	8	μA
		AGC attack; fast mode after tuning and AGC switching	100	150	200	μA
$I_{sink(AGC)}$	AGC sink current	AGC release; normal mode	0.7	1	1.4	μA
		AGC release; fast mode after tuning and AGC switching	17.5	25	35	μA
AM demodulator; pin MPXOUT						
V_o	output voltage	$m = 30\%$	175	210	250	mV
Audio output; pins LOUT and ROUT						
V_o	output voltage	$m = 30\%$; $f_{AF} = 400\text{ Hz}$; data byte 3h bits DEMP[1:0] = 10				
		data byte 3h bit OUTA = 1	200	270	355	mV
		data byte 3h bit OUTA = 0	85	115	150	mV

Table 62. Dynamic characteristics ...continued

$V_{CC} = 8.5\text{ V}$; $T_{amb} = 25\text{ °C}$; unless otherwise specified.

FM condition: all RF voltages refer to an unterminated RMS voltage with a source impedance $75\ \Omega$; $f_{mod} = 1\text{ kHz}$, $\Delta f = 22.5\text{ kHz}$, de-emphasis = $50\ \mu\text{s}$, $f_{RF} = 97.1\text{ MHz}$; unless otherwise specified.

AM condition: all RF voltages are RMS values measured at the input of a $15\text{ pF} / 60\text{ pF}$ dummy aerial; $f_{mod} = 400\text{ Hz}$, $m = 30\%$, $f_{RF} = 990\text{ kHz}$; unless otherwise specified.

All values measured in a test circuit according to [Figure 30](#); default settings; audio signals measured at LOUT and ROUT with IEC tuner filter (200 Hz to 15 kHz; IEC 60315-4); unless otherwise specified.

Symbol	Parameter	Conditions	Min	Typ	Max	Unit
α_{AF}	AF attenuation	referenced to $f_{AF} = 400\text{ Hz}$				
		$f_{AF} = 100\text{ Hz}$; data byte 3h bit LOCUT = 1	-4.5	-3	-1.5	dB
		$f_{AF} = 1.5\text{ kHz}$; data byte 3h bits DEMP[1:0] = 10	-4	-3	-2	dB
THD	total harmonic distortion	$V_{i(RF)} = 1\text{ mV}$; $m = 80\%$	-	0.7	1	%
α_{ripple}	ripple rejection	V_{ripple} / V_{audio} ; $V_{ripple} = 100\text{ mV}$; $f_{ripple} = 100\text{ Hz}$	24	31	-	dB
AM noise blanker						
SINAD	signal-to-noise-and-distortion ratio	$m = 30\%$; $f_{AF} = 1\text{ kHz}$; noise pulses at RF input signal $t_p = 100\text{ ns}$; $t_r < 1\text{ ns}$; $t_f < 1\text{ ns}$; $f_p = 100\text{ Hz}$; $V_p = 500\text{ mV}$; $V_{i(RF)} = 40\text{ dB}\mu\text{V}$	-	12	-	dB
AM RSSI; pin RSSI						
V_{RSSI}	RSSI voltage	$V_{i(RF)} = -20\text{ dB}\mu\text{V}$ at dummy aerial input	1.05	1.2	1.35	V
		$V_{i(RF)} = 14\text{ dB}\mu\text{V}$ at dummy aerial input	1.7	1.9	2.1	V
		$V_{i(RF)} = 34\text{ dB}\mu\text{V}$ at dummy aerial input	2.65	2.9	3.15	V
		$V_{i(RF)} = 54\text{ dB}\mu\text{V}$ at dummy aerial input	3.5	3.8	4.1	V
$\Delta V_{RSSI} / \Delta L_{i(RF)}$	RSSI voltage difference to RF input level difference ratio	$5\ \mu\text{V} < V_{i(RF)} < 50\ \mu\text{V}$	45	50	55	mV/dB
AM IF counter						
$V_{i(sens)}$	input sensitivity voltage	$V_{i(RF)}$ at which IF counter starts; $m = 0\%$	-	14	20	$\text{dB}\mu\text{V}$
$f_{IFc(res)}$	IF counter frequency resolution		-	500	-	Hz

[1] $f_{LO} = f_{RF} + f_{IF}$ for high injection and $f_{LO} = f_{RF} - f_{IF}$ for low injection.

[2] The switched input capacitance is part of the switched RF AGC function.

[3] The input impedance of the AM LNA depends on the AGC state.

13. Application information

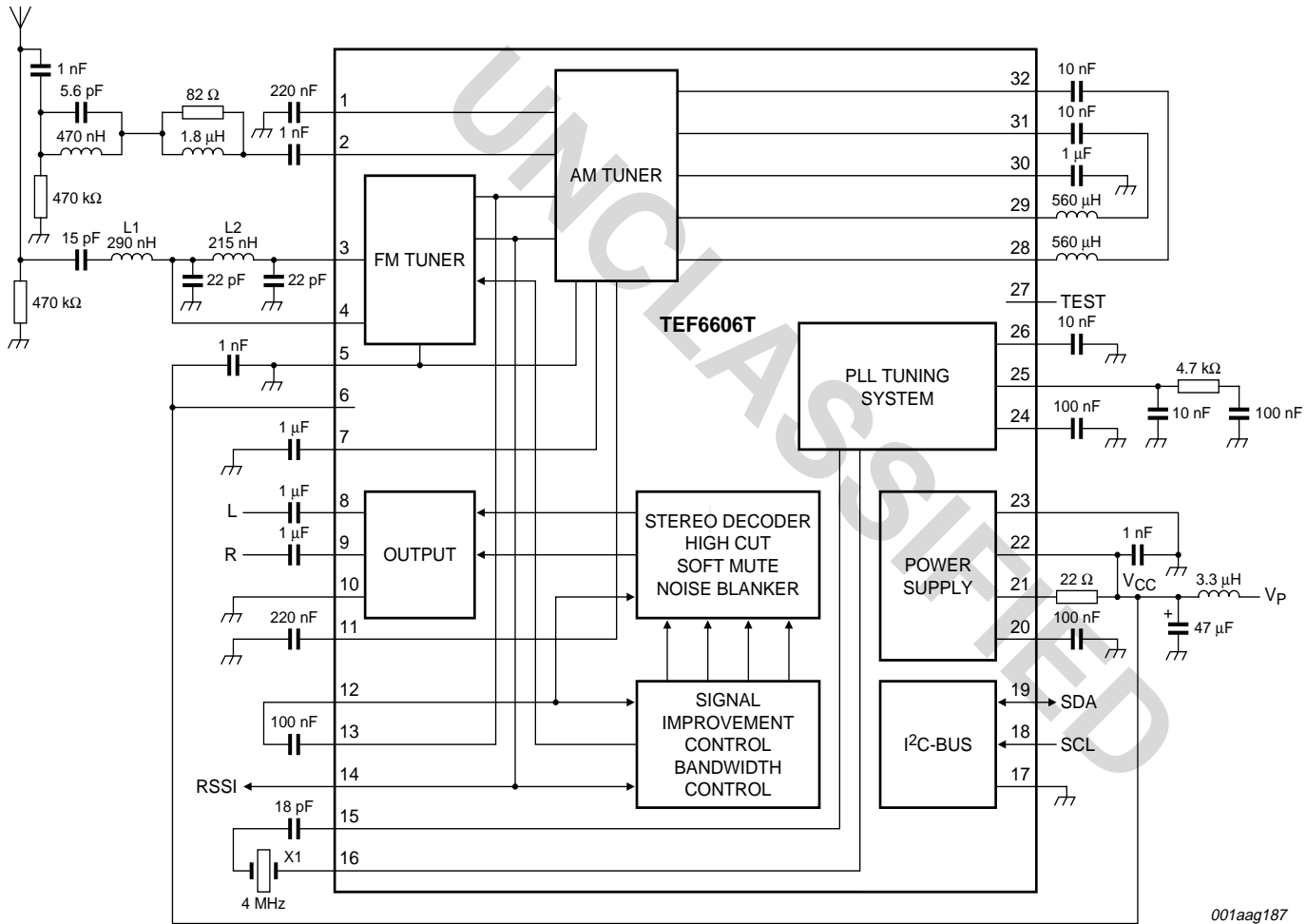

001aag187

For list of components see [Table 64](#).

Fig 29. Application diagram of TEF6606T

Table 63. 4MHz crystal specification for [Figure 29](#) and [Figure 30](#)

Parameter	Symbol	Value	Unit
Nominal frequency	F_n	4.000	MHz
Oscillation mode		fundamental	
Load capacitance	C_L	18	pF
Shunt capacitance	C_O	7 max.	pF
Motional capacitance	C_1	10 typ.	fF
Series resistance	R_R	150 max.	Ω
Accuracy at 25 °C	ΔF_N	+/-25	ppm
Ageing	ΔF_N	+/-5	ppm
Temperature stability	ΔF_N	+/-30	ppm
Operating temperature range	T	-40 /+85	°C

UNCLASSIFIED

14. Test information

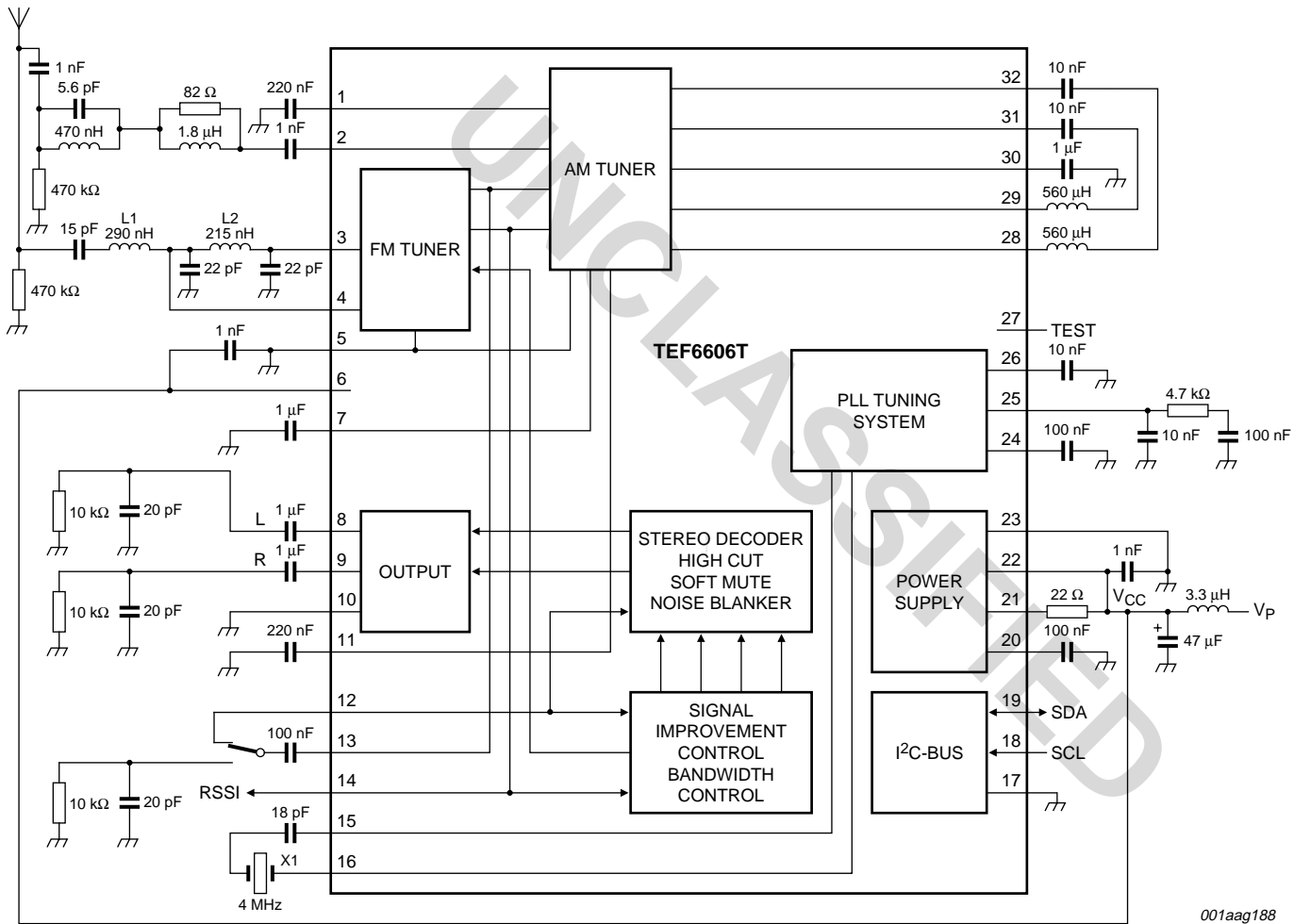

001aag188

For list of components see [Table 64](#).

Fig 30. Test circuit of TEF6606T

Table 64. List of components for Figure 29 and Figure 30

Symbol	Component	Type	Manufacturer
L1	FM RF input 1	290 nH; LQH31HNR29K03L	muRata
L2	FM RF input 2	215 nH; LQH31HNR21K01L	muRata
X1	crystal 4 MHz	LN-G102-1413	NDK

Table 65. DC operating points

$V_{i(RF)} = 0 \mu V$; audio output gain low; unless otherwise specified.

Symbol	Pin	Unloaded DC voltage (V)					
		AM mode			FM mode		
		Min	Typ	Max	Min	Typ	Max
AMRFDEC	1	-	4.1	-	floating	-	-
AMRFIN	2	-	2.85	-	-	-	-
FMIN2	3	-	-	-	-	3.1	-
FMIN1	4	-	-	-	-	3.1	-
GNDRF	5	external GND			external GND		
V _{CC2}	6	external 8.5			external 8.5		
AMRFAGC	7	floating			-	-	-
LOUT	8	-	3.8	-	-	3.8	-
ROUT	9	-	3.8	-	-	3.8	-
GNDAUD	10	external GND			external GND		
AMIFAGC2	11	-	-	-	-	-	-
MPXIN	12	-	3.7	-	-	3.7	-
MPXOUT	13	-	4	-	-	4	-
RSSI	14	-	1.3	-	-	1.3	-
XTAL2	15	-	6.5	-	-	6.5	-
XTAL1	16	-	6.5	-	-	6.5	-
GNDD	17	external GND			external GND		
SCL	18	external I ² C-bus voltage			external I ² C-bus voltage		
SDA	19	external I ² C-bus voltage			external I ² C-bus voltage		
VREF	20	3.9	4.0	4.1	3.9	4.0	4.1
VREGSUP	21	5.6	6.5	7	5.6	6.5	7
V _{CC1}	22	external 8.5			external 8.5		
GND	23	external GND			external GND		
VCODEC	24	-	5.7	-	-	5.7	-
PLL	25	1.2	-	5.5	1.2	-	5.5
PLLREF	26	-	2.25	-	-	2.25	-
TEST	27	-	-	-	-	-	-
AMSELIN1	28	7	-	V _{CC}	7	-	V _{CC}
AMSELIN2	29	7	-	V _{CC}	7	-	V _{CC}
AMIFAGC1	30	-	5.5	-	-	-	-
AMSELOUT1	31	7	-	V _{CC}	7	-	V _{CC}
AMSELOUT2	32	7	-	V _{CC}	7	-	V _{CC}

14.1 Quality information

This product has been qualified in accordance with the Automotive Electronics Council (AEC) standard Q100 (Stress qualification for integrated circuits) and is suitable for use in automotive critical applications.

UNCLASSIFIED

15. Package outline

SO32: plastic small outline package; 32 leads; body width 7.5 mm

SOT287-1

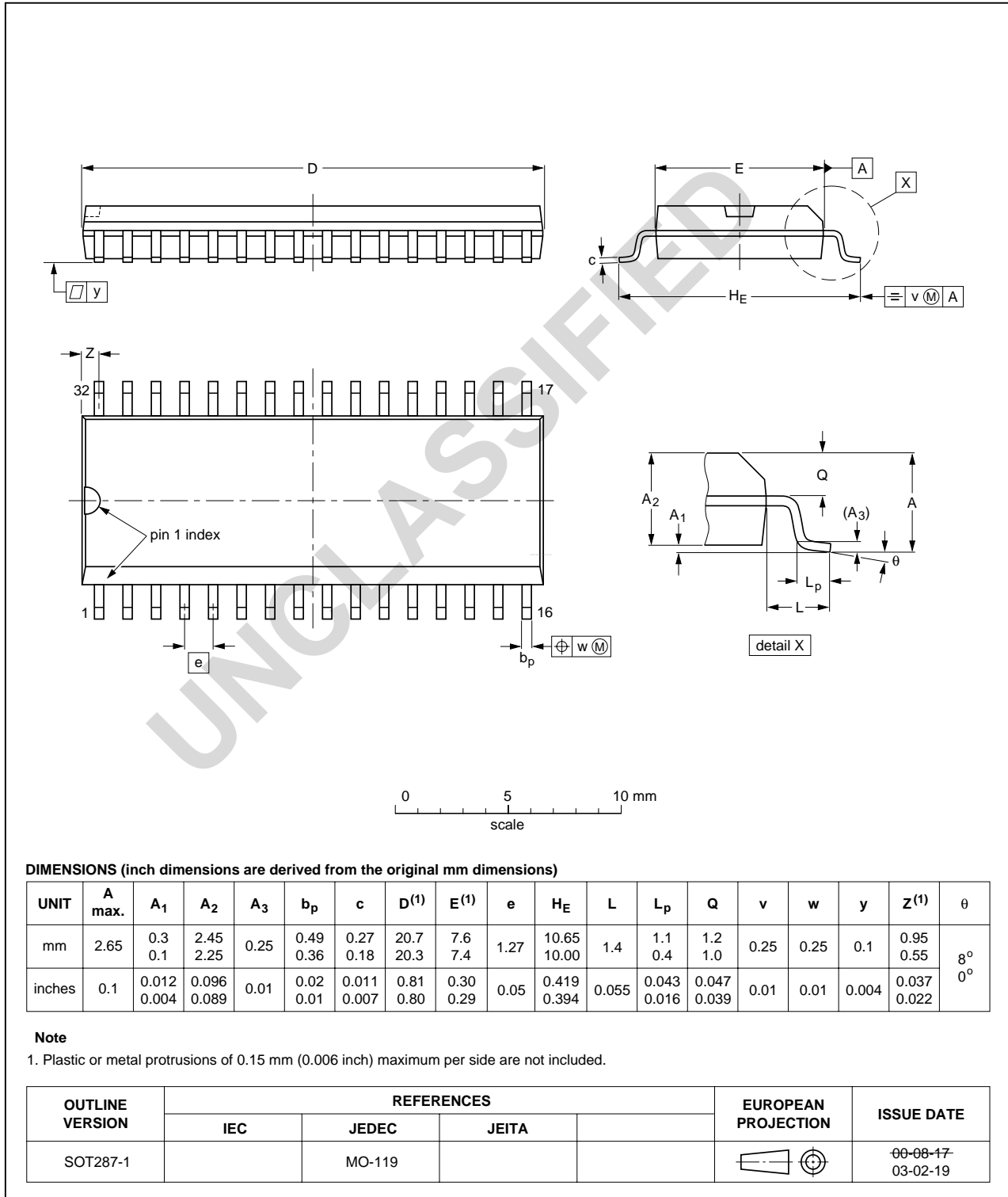

Fig 31. Package outline SOT287-1 (SO32)

16. Soldering

This text provides a very brief insight into a complex technology. A more in-depth account of soldering ICs can be found in Application Note AN10365 "Surface mount reflow soldering description".

16.1 Introduction to soldering

Soldering is one of the most common methods through which packages are attached to Printed Circuit Boards (PCBs), to form electrical circuits. The soldered joint provides both the mechanical and the electrical connection. There is no single soldering method that is ideal for all IC packages. Wave soldering is often preferred when through-hole and Surface Mount Devices (SMDs) are mixed on one printed wiring board; however, it is not suitable for fine pitch SMDs. Reflow soldering is ideal for the small pitches and high densities that come with increased miniaturization.

16.2 Wave and reflow soldering

Wave soldering is a joining technology in which the joints are made by solder coming from a standing wave of liquid solder. The wave soldering process is suitable for the following:

- Through-hole components
- Leaded or leadless SMDs, which are glued to the surface of the printed circuit board

Not all SMDs can be wave soldered. Packages with solder balls, and some leadless packages which have solder lands underneath the body, cannot be wave soldered. Also, leaded SMDs with leads having a pitch smaller than ~0.6 mm cannot be wave soldered, due to an increased probability of bridging.

The reflow soldering process involves applying solder paste to a board, followed by component placement and exposure to a temperature profile. Leaded packages, packages with solder balls, and leadless packages are all reflow solderable.

Key characteristics in both wave and reflow soldering are:

- Board specifications, including the board finish, solder masks and vias
- Package footprints, including solder thieves and orientation
- The moisture sensitivity level of the packages
- Package placement
- Inspection and repair
- Lead-free soldering versus PbSn soldering

16.3 Wave soldering

Key characteristics in wave soldering are:

- Process issues, such as application of adhesive and flux, clinching of leads, board transport, the solder wave parameters, and the time during which components are exposed to the wave
- Solder bath specifications, including temperature and impurities

16.4 Reflow soldering

Key characteristics in reflow soldering are:

- Lead-free versus SnPb soldering; note that a lead-free reflow process usually leads to higher minimum peak temperatures (see [Figure 32](#)) than a PbSn process, thus reducing the process window
- Solder paste printing issues including smearing, release, and adjusting the process window for a mix of large and small components on one board
- Reflow temperature profile; this profile includes preheat, reflow (in which the board is heated to the peak temperature) and cooling down. It is imperative that the peak temperature is high enough for the solder to make reliable solder joints (a solder paste characteristic). In addition, the peak temperature must be low enough that the packages and/or boards are not damaged. The peak temperature of the package depends on package thickness and volume and is classified in accordance with [Table 66](#) and [67](#)

Table 66. SnPb eutectic process (from J-STD-020C)

Package thickness (mm)	Package reflow temperature (°C)	
	Volume (mm ³)	
	< 350	≥ 350
< 2.5	235	220
≥ 2.5	220	220

Table 67. Lead-free process (from J-STD-020C)

Package thickness (mm)	Package reflow temperature (°C)		
	Volume (mm ³)		
	< 350	350 to 2000	> 2000
< 1.6	260	260	260
1.6 to 2.5	260	250	245
> 2.5	250	245	245

Moisture sensitivity precautions, as indicated on the packing, must be respected at all times.

Studies have shown that small packages reach higher temperatures during reflow soldering, see [Figure 32](#).

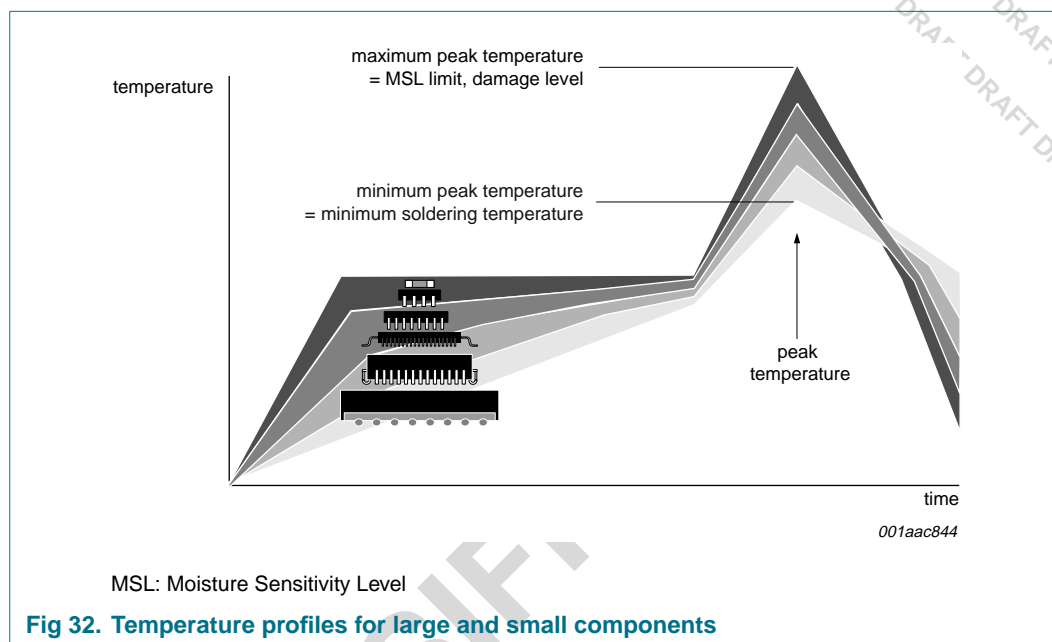

For further information on temperature profiles, refer to Application Note AN10365 “Surface mount reflow soldering description”.

17. Abbreviations

Table 68. Abbreviations

Acronym	Description
AGC	Automatic Gain Control
HCC	High-Cut Control
IF	Intermediate Frequency
LO	Local Oscillator
LW	Long Wave
MPX	Multiplex
MW	Medium Wave
PACS	Precision Adjacent Channel Suppression
PLL	Phase-Locked Loop
RF	Radio Frequency
RSSI	Received Signal Strength Indication
SW	Short Wave
USN	UltraSonic Noise
VCO	Voltage-Controlled Oscillator
WAM	Wideband AM

18. Revision history

Table 69. Revision history

Document ID	Release date	Data sheet status	Change notice	Supersedes
TEF6606_1	yyymmdd	Objective data sheet	-	-
Modifications:				
				<ul style="list-style-type: none">• Updated Figure 5 to Figure 15, Figure 29 and Figure 30• Changed device type identification in Section 8.1.5• Changed text inset in Section 14.1

UNCLASSIFIED

19. Legal information

19.1 Data sheet status

Document status ^{[1][2]}	Product status ^[3]	Definition
Objective [short] data sheet	Development	This document contains data from the objective specification for product development.
Preliminary [short] data sheet	Qualification	This document contains data from the preliminary specification.
Product [short] data sheet	Production	This document contains the product specification.

[1] Please consult the most recently issued document before initiating or completing a design.

[2] The term 'short data sheet' is explained in section "Definitions".

[3] The product status of device(s) described in this document may have changed since this document was published and may differ in case of multiple devices. The latest product status information is available on the Internet at URL <http://www.nxp.com>.

19.2 Definitions

Draft — The document is a draft version only. The content is still under internal review and subject to formal approval, which may result in modifications or additions. NXP Semiconductors does not give any representations or warranties as to the accuracy or completeness of information included herein and shall have no liability for the consequences of use of such information.

Short data sheet — A short data sheet is an extract from a full data sheet with the same product type number(s) and title. A short data sheet is intended for quick reference only and should not be relied upon to contain detailed and full information. For detailed and full information see the relevant full data sheet, which is available on request via the local NXP Semiconductors sales office. In case of any inconsistency or conflict with the short data sheet, the full data sheet shall prevail.

19.3 Disclaimers

General — Information in this document is believed to be accurate and reliable. However, NXP Semiconductors does not give any representations or warranties, expressed or implied, as to the accuracy or completeness of such information and shall have no liability for the consequences of use of such information.

Right to make changes — NXP Semiconductors reserves the right to make changes to information published in this document, including without limitation specifications and product descriptions, at any time and without notice. This document supersedes and replaces all information supplied prior to the publication hereof.

Suitability for use — NXP Semiconductors products are not designed, authorized or warranted to be suitable for use in medical, military, aircraft, space or life support equipment, nor in applications where failure or malfunction of a NXP Semiconductors product can reasonably be expected to

result in personal injury, death or severe property or environmental damage. NXP Semiconductors accepts no liability for inclusion and/or use of NXP Semiconductors products in such equipment or applications and therefore such inclusion and/or use is at the customer's own risk.

Applications — Applications that are described herein for any of these products are for illustrative purposes only. NXP Semiconductors makes no representation or warranty that such applications will be suitable for the specified use without further testing or modification.

Limiting values — Stress above one or more limiting values (as defined in the Absolute Maximum Ratings System of IEC 60134) may cause permanent damage to the device. Limiting values are stress ratings only and operation of the device at these or any other conditions above those given in the Characteristics sections of this document is not implied. Exposure to limiting values for extended periods may affect device reliability.

Terms and conditions of sale — NXP Semiconductors products are sold subject to the general terms and conditions of commercial sale, as published at <http://www.nxp.com/profile/terms>, including those pertaining to warranty, intellectual property rights infringement and limitation of liability, unless explicitly otherwise agreed to in writing by NXP Semiconductors. In case of any inconsistency or conflict between information in this document and such terms and conditions, the latter will prevail.

No offer to sell or license — Nothing in this document may be interpreted or construed as an offer to sell products that is open for acceptance or the grant, conveyance or implication of any license under any copyrights, patents or other industrial or intellectual property rights.

19.4 Trademarks

Notice: All referenced brands, product names, service names and trademarks are the property of their respective owners.

I²C-bus — logo is a trademark of NXP B.V.

20. Contact information

For additional information, please visit: <http://www.nxp.com>

For sales office addresses, send an email to: salesaddresses@nxp.com

Please be aware that important notices concerning this document and the product(s) described herein, have been included in section 'Legal information'.

© NXP B.V. 2007.

All rights reserved.

For more information, please visit: <http://www.nxp.com>

For sales office addresses, please send an email to: salesaddresses@nxp.com

Date of release: 12 June 2007

Document identifier: TEF6606_1

founded by

PHILIPS

21. Contents

1	General description	1
2	Features	1
3	Quick reference data	2
4	Ordering information	2
5	Block diagram	3
6	Pinning information	4
6.1	Pinning	4
6.2	Pin description	4
7	Functional description	5
7.1	FM tuner	5
7.2	AM tuner	5
7.3	PLL tuning system	5
7.4	Signal dependent FM IF bandwidth control ...	5
7.5	FM stereo decoder	5
7.6	Weak signal processing and noise blanker. ...	5
7.7	I ² C-bus transceiver	6
8	I²C-bus protocol	6
8.1	Read mode	6
8.1.1	Read mode: data byte STATUS	7
8.1.2	Read mode: data byte LEVEL	7
8.1.3	Read mode: data byte USN_WAM	8
8.1.4	Read mode: data byte IFCOUNTER	8
8.1.5	Read mode: data byte ID	9
8.2	Write mode	9
8.2.1	Mode and subaddress byte for write.	10
8.2.2	Write mode: data byte TUNER0	22
8.2.3	Write mode: data byte TUNER1	22
8.2.4	Write mode: data byte TUNER2	23
8.2.5	Write mode: data byte RADIO	24
8.2.6	Write mode: data byte SOFTMUTE0	24
8.2.7	Write mode: data byte SOFTMUTE1	25
8.2.8	Write mode: data byte SOFTMUTE2_FM. ...	27
8.2.9	Write mode: data byte SOFTMUTE2_AM ...	29
8.2.10	Write mode: data byte HIGHCUT0	29
8.2.11	Write mode: data byte HIGHCUT1	30
8.2.12	Write mode: data byte HIGHCUT2	32
8.2.13	Write mode: data byte STEREO0	34
8.2.14	Write mode: data byte STEREO1	35
8.2.15	Write mode: data byte STEREO2	36
8.2.16	Write mode: data byte CONTROL	38
8.2.17	Write mode: data byte LEVEL_OFFSET ...	38
8.2.18	Write mode: data byte AM_LNA	39
9	Limiting values	39
10	Thermal characteristics	40
11	Static characteristics	40
12	Dynamic characteristics	41
13	Application information	49
14	Test information	50
14.1	Quality information	52
15	Package outline	53
16	Soldering	54
16.1	Introduction to soldering	54
16.2	Wave and reflow soldering	54

16.3	Wave soldering	54
16.4	Reflow soldering	55
17	Abbreviations	56
18	Revision history	57
19	Legal information	58
19.1	Data sheet status	58
19.2	Definitions	58
19.3	Disclaimers	58
19.4	Trademarks	58
20	Contact information	58
21	Contents	59

UNCLASSIFIED

DRAFT DRAFT DRAFT DRAFT DRAFT DRAFT DRAFT DRAFT DRAFT DRAFT