



Version	0.3
Total pages	22
Date	2008.07.07

Product Specification

6.1" color TFT-LCD module

MODEL NAME : C061FW01 V0

- (◆) Preliminary Specification
- (.....) Final Specification

Rohs Compliance

Note: The content of this specification is subject to change.

© 2008 AU Optronics
All Rights Reserved,
Do Not Copy.



Record of Revision

Version	Revise Date	Page	Content
0.0	03/June/2008	-	First draft.
0.1	16/June/2008	4	Pin definition Update
		14	Sampling Clock Timing
0.2	20/June/2008	9	Optical specification, Brightness I_L changed to 80mA
		13	Mechanical Drawing updates, FPC pin changed from 32pin to 30pin
0.3	07/July/2008	5-6	Add CPH2.CPH3
		7-14	AC timing diagram
		15-16	Power on/off sequence

Contents:

A. Physical specification	P3
B. Electrical specifications	P4
1. Pin assignment.....	P4
a. TFT-LCD panel driving section.....	P5
b. Back light driving section.....	P5
2. Absolute maximum ratings.....	P5
3. Electrical characteristics.....	P6
a. Typical operating conditions.....	P6
b. Current consumption.....	P6
c. Backlight driving conditions.....	P6
4. AC Timing.....	P7
a. Timing conditions.....	P7
b. Timing diagram.....	P9
5. Power sequence.....	P15
C. Optical specifications	P17
D. Reliability test items	P19
E. Packing form	P20
F. Mechanical Drawing	P21
G. MOD setting	P22

Appendix:

Fig.1 Input Timing Chart.....	P9
Fig.2 Sampling clock timing.	P10
Fig.3 Horizontal display timing range.	P11
Fig.4 Horizontal timing.	P12
Fig.5 Vertical shift clock timing.	P13
Fig.6 Vertical timing (From up to down).....	P14
Fig.7 Outline dimension of TFT-LCD module.....	P21
Fig.8 MOD Setting	P22

A. Physical specifications

NO.	Item	Specification	Remark
1	Display resolution(dot)	480RGB(W)x234(H)	
2	Active area(mm)	136.08(W)x71.955(H)	
3	Screen size(inch)	6.1(Diagonal)	
4	Dot pitch(mm)	0.0945(W)x 0.3075(H)	
5	Color configuration	R. G. B. stripe	
6	NTSC ratio	50%	
7	Overall dimension(mm)	149.0(W)x82.9(H)x5.8(D)	Note 1
8	Weight (g)	TBD	
9	Surface treatment	AG(25%) with SWV film	
10	Backlight unit	LED	
11	Gray scale inversion direction	6 o'clock	

Note 1: Refer to Fig. 7

B. Electrical specifications

1. Pin assignment

a. TFT-LCD panel driving section

Pin no	Symbol	I/O	Description	Remark
1	GND	-	Ground for logic circuit	
2	NC	-		
3	V _{GL}	I	Negative power for scan driver	
4	STVD	I/O	Vertical start pulse	Note 1
5	UDC	I	UP/DOWN scan control input	Note 1,2
6	CKV	I	Shift clock input for scan driver	
7	OEV	I	Output enable input for scan driver	
8	NC	-		
9	NC	-		
10	STVU	I/O	Vertical start pulse	Note 1
11	V _{CC}	I	Supply voltage of logic control circuit for scan driver	Note 4
12	DV _{CC}	I	Supply voltage of logic control circuit for data driver	Note 4
13	V _{GH}	I	Positive power for scan driver	
14	NC	-		
15	VCOM	I	Common electrode driving signal	
16	STHR	I/O	Start pulse for horizontal scan line	Note 1
17	AV _{DD}	I	Supply voltage for analog circuit	
18	VR	I	Alternated video signal input(Red)	
19	VG	I	Alternated video signal input(Green)	
20	VB	I	Alternated video signal input(Blue)	
21	AGND	-	Ground for analog circuit	
22	CPH1	I	Sampling and shifting clock pulse for data driver	
23	CPH2	I	Sampling and shifting clock pulse for data driver	
24	CPH3	I	Sampling and shifting clock pulse for data driver	
25	GND	-	Ground for logic circuit	
26	MOD	I	Sequential sampling and simultaneous sampling setting	Note 3
27	LRC	I	LEFT/RIGHT scan control input	Note 1,2
28	OEH	I	Output enable input for data driver	
29	STHL	I/O	Start pulse for horizontal scan line	
30	GND	-	Ground for logic circuit	

Note 1: Selection of scanning mode (please refer to the following table)

Setting of scan control input		IN/OUT state for start pulse				Scanning direction
UDC	LRC	STVD	STVU	STHR	STHL	
GND	V _{CC}	OUT	IN	OUT	IN	From up to down, and from left to right.
V _{CC}	GND	IN	OUT	IN	OUT	From down to up, and from right to left.
GND	GND	OUT	IN	IN	OUT	From up to down, and from right to left.
V _{CC}	V _{CC}	IN	OUT	OUT	IN	From down to up, and from left to right.

IN: Input; OUT: Output.

Note 2: Definition of scanning direction.

Refer to figure as below:

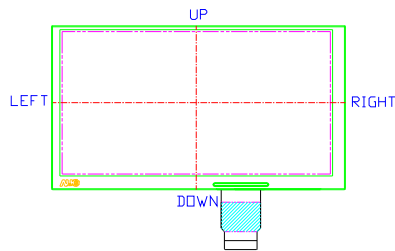

Note 3: MOD = H: Simultaneous sampling.

MOD = L: Sequential sampling.

Please set CPH2 and CPH3 to GND when MOD = H.

Note 4: Electrical characteristics of V_{CC} and DV_{CC} are the same.

b. Backlight driving section (Refer to Fig. 7)

No.	Symbol	I/O	Description	Remark
1	HI	I	Power supply for backlight unit (High voltage)	--
2	GND	-	Ground for backlight unit	--

2. Absolute maximum ratings

Item	Symbol	Condition	Min.	Max.	Unit	Remark
Power voltage	V _{CC}	GND=0	-0.3	7	V	
	AV _{DD}	AGND=0	-0.3	7	V	
	V _{GH}	GND=0	-0.3	18	V	
	V _{GL}		-15	0.3	V	
	V _{GH} - V _{GL}		-	33	V	
Input signal voltage	V _i		-0.3	AV _{DD} +0.3	V	Note 1
	V _l		-0.3	V _{CC} +0.3	V	Note 2
	V _{COM}		-2.9	7.5	V	
LED	V _F	I _F = 80mA		28	V	
	I _F			TBD	mA	
Operation temperature	T _{opr}	Ambient	-30	85	°C	
Storage temperature	T _{stg}	Ambient	-40	95	°C	

Note 1: VR, VG, VB.

Note 2: STHL, STHR, OEH, LRC, CPH1~CPH3, STVD, STVU, OEV, CKV, UDC, MOD.

3. Electrical characteristics

a. Typical operating conditions (GND=AGND=0V, Note 3)

Item	Symbol	Min.	Typ.	Max.	Unit	Remark
Power supply	V _{CC}	3	3.3	5.5	V	Note4
	AV _{DD}	4.5	5	5.5	V	
	V _{GH}	14.3	15	15.7	V	
	V _{GL}	-10.5	-10	-9.5	V	
Video signal amplitude (VR, VG, VB)	V _{iA}	0.4	-	AV _{DD} -0.4	V	Note 1
	V _{iAC}	-	TBD	-	V	AC component
	V _{iDC}	-	AV _{DD} /2	-	V	DC component
VCOM	V _{CAC}		TBD		Vp-p	AC component
	V _{CDC}		TBD		V	DC component
Input signal voltage	H Level	V _{IH}	0.8 V _{CC}	-	V _{CC}	Note 2
	L Level	V _{IL}	0	-	0.2 V _{CC}	

Note 1: Refer to Fig.4.

Note 2: STHL, STHR, OEH, LRC, CPH1~CPH3, STVD, STVU, OEV, CKV, UDC, MOD.

Note 3: Be sure to apply GND, V_{CC} and V_{GL} to the LCD first, and then apply V_{GH}.

Note 4: If input signal amplitude is 3.3V, recommend value for V_{CC} is 3.3V

If input signal amplitude is 5V, recommend value for V_{CC} is 5V

b. Current consumption (GND=AGND=0V)

Parameter	Symbol	Condition	Min.	Typ.	Max.	Unit	Remark
Current for driver	I _{GH}	V _{GH} =15V	-	TBD	0.5	mA	
	I _{GL}	V _{GL} =-10V	-	TBD	0.5	mA	
	I _{CC}	DV _{CC} =5V	-	TBD	6.0	mA	Note 1
	I _{DD}	AV _{DD} =5V	-	TBD	30	mA	

Note 1: I_{CC} is current consumption of DV_{CC} plus V_{CC}.

c. Backlight driving conditions (Self-heating type, Note1, Note3)

Parameter	Symb	Min.	Typ.	Max.	Unit	Remark
LED current	I _L		80		mA	Note1
LED voltage	V _L		25.2	28	V	Note1
LED Life Time	L _L	10,000			Hrs	Note2

Note 1 : Refer to below LED connection scheme

Note 2 : Under 25°C, I_L = 80mA, continuous operation.

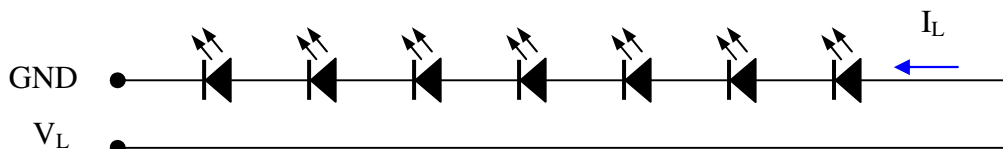

4. AC Timing

a. Timing conditions

Parameter	Symbol	Min.	Typ.	Max.	Unit.	Remark
Rising time	t_r	-	-	10	ns	Note 1
Falling time	t_f	-	-	10	ns	Note 1
High and low level pulse width	t_{CPH}	95	103	107	ns	CPH1
		66			ns	Note3
CPH pulse duty	t_{CWH}	40	50	60	%	CPH1
CPH pulse delay	t_{C12}	30	$t_{CPH}/3$	$t_{CPH}/2$	ns	CPH1
STH setup time	t_{SUH}	20	-	-	ns	STHR,STHL
STH hold time	t_{HDH}	20	-	-	ns	STHR,STHL
STH pulse width	t_{STH}	-	1	-	t_{CPH}	STHR,STHL
STH period	t_H	61.5	63.5	65.5	μs	STHR,STHL
OEH pulse width	t_{OEH}	0.475	3.48	6.48	μs	OEH (Note5)
Sample and hold disable time	t_{DIS1}	5.5	8.78	8.88	μs	(Note6)
OEV pulse width	t_{OEV}	2.0	3.4	6.5	μs	OEV
CKV pulse width	t_{CKV}	1.0	3.1	4.68	μs	CKV
Clean enable time	t_{DIS2}	1.0	2.2	4.1-	μs	Note7
Horizontal display start	t_{SH}	-	1	-	t_{CPH}	Note8
Horizontal display timing range	t_{DH}	-	480	-	t_{CPH}	Note8
STV setup time	t_{SUV}	400	-	-	ns	STVU, STVD
STV hold time	t_{HDV}	400	-	-	ns	STVU, STVD
STV pulse width	t_{STV}	-	-	1	t_H	STVU, STVD (Note4)
Horizontal lines per field	t_V	256	262	268	t_H	Note 2
Vertical display start	t_{SV}		3	-	t_H	
Vertical display timing range	t_{DV}		234	-	t_H	
VCOM rising time	t_{rCOM}		-	5	μs	
VCOM falling time	t_{fCOM}		-	5	μs	
VCOM delay time	t_{DCOM}	0	-		μs	
Setup time of analog	t_{asu}	60			ns	
Hold time of analog VR/VG/VB	t_{ahd}	40			ns	

Note 1: For all of the logic signals.

Note 2: Please don't use odd horizontal lines to drive LCD panel for both odd and even field simultaneously.

Note 3: For Partial mode (4:3, side-black)

Note 4: Maximum time is one line period.

Note5: The maximum pulse width of OEH should refer to the minimum of t_{DIS1} and the hsync back porch.



Note 6: t_{dis1} is time difference between OEH and STHL

Note 7: t_{dis2} is time difference between OEV and CKV

Note 8: The unit is t_{CPH}

b. Timing diagram

Please refer to the attached drawing, from Fig.1 to Fig.6 and Fig8.

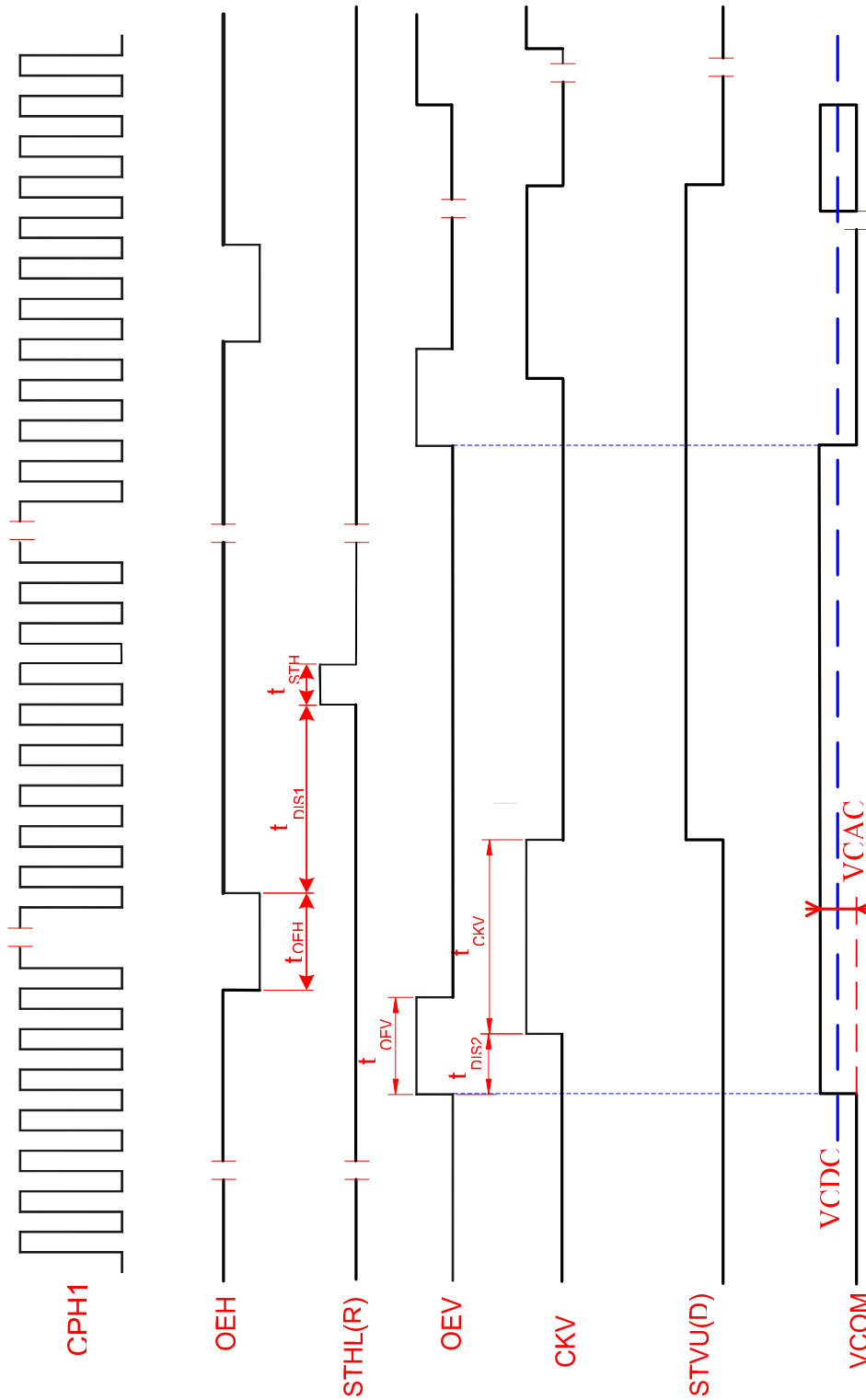

Fig.1 Input Timing Chart

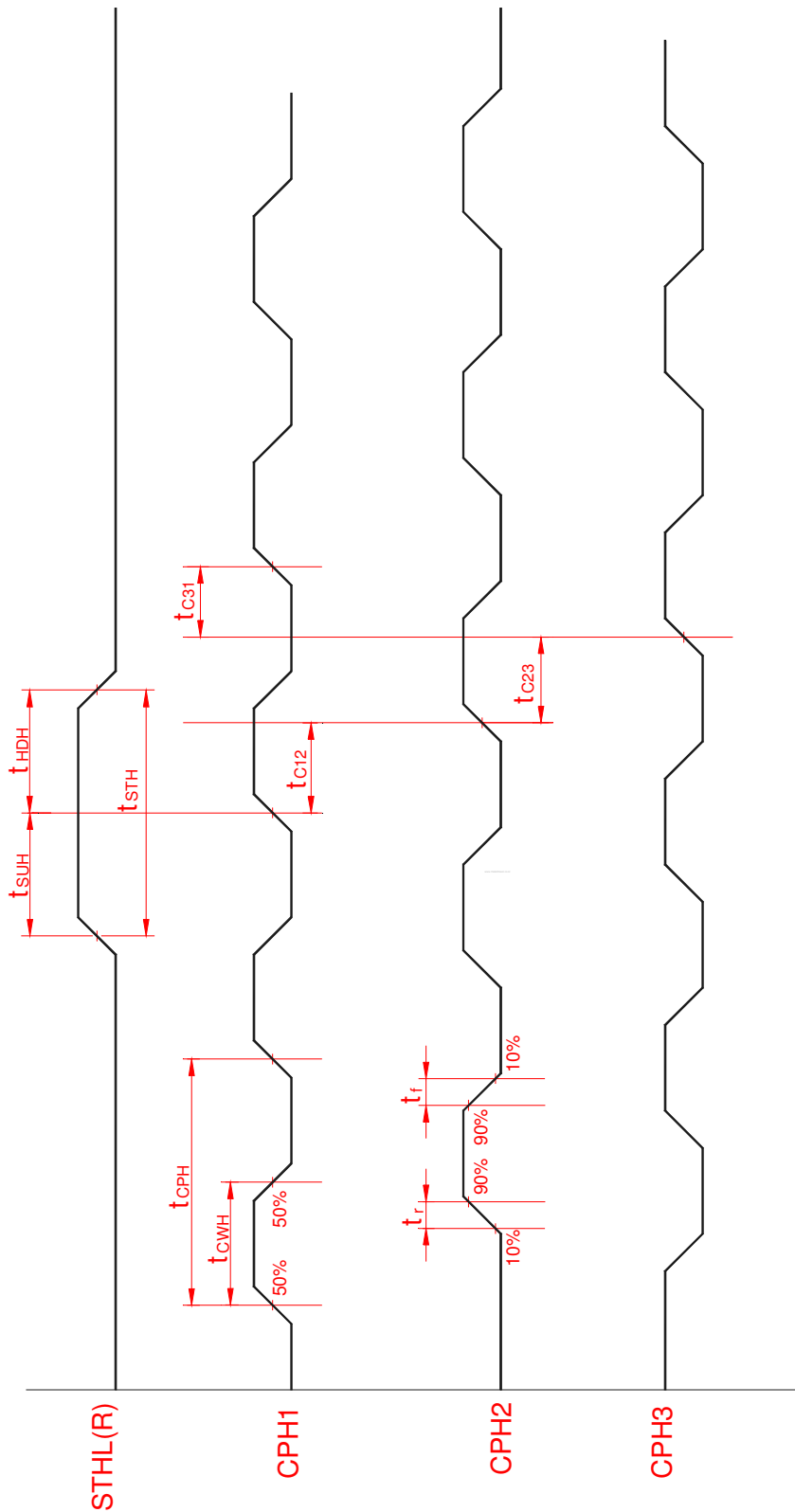

Fig.2 Sampling clock timing

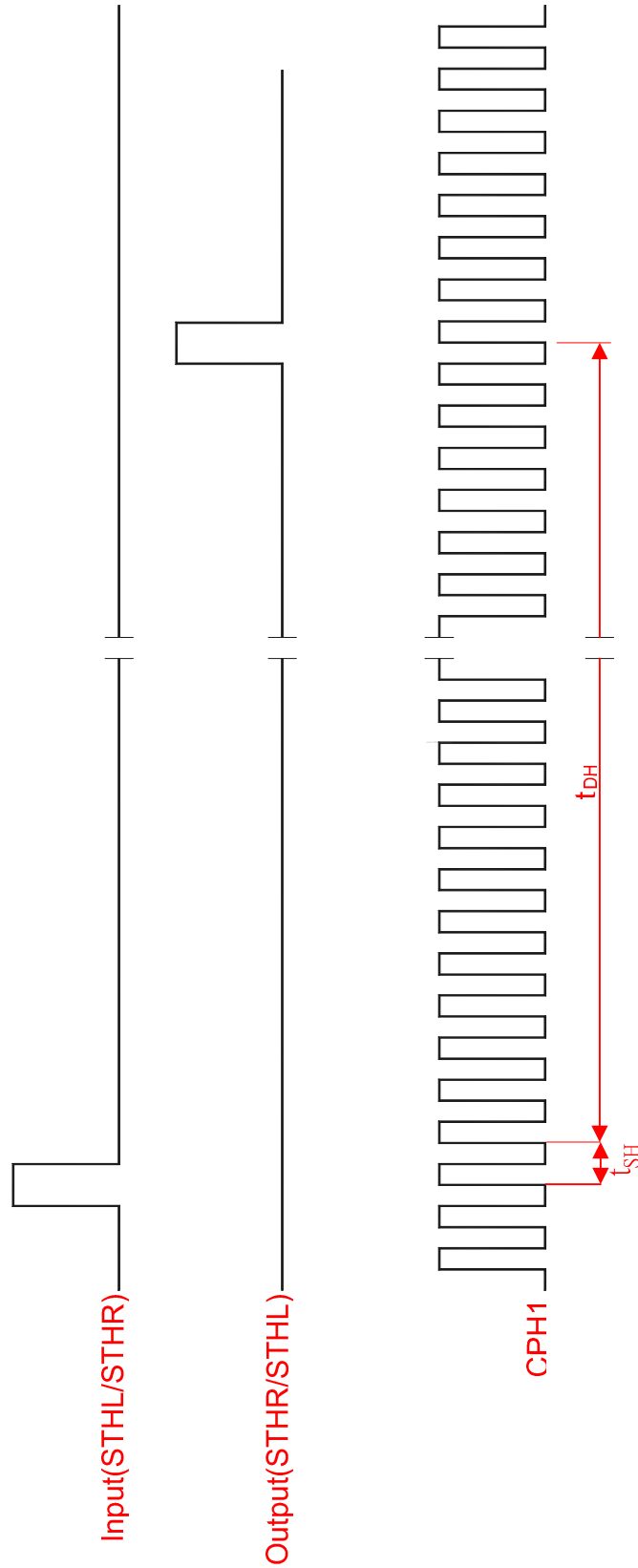

Fig.3 Horizontal display timing range

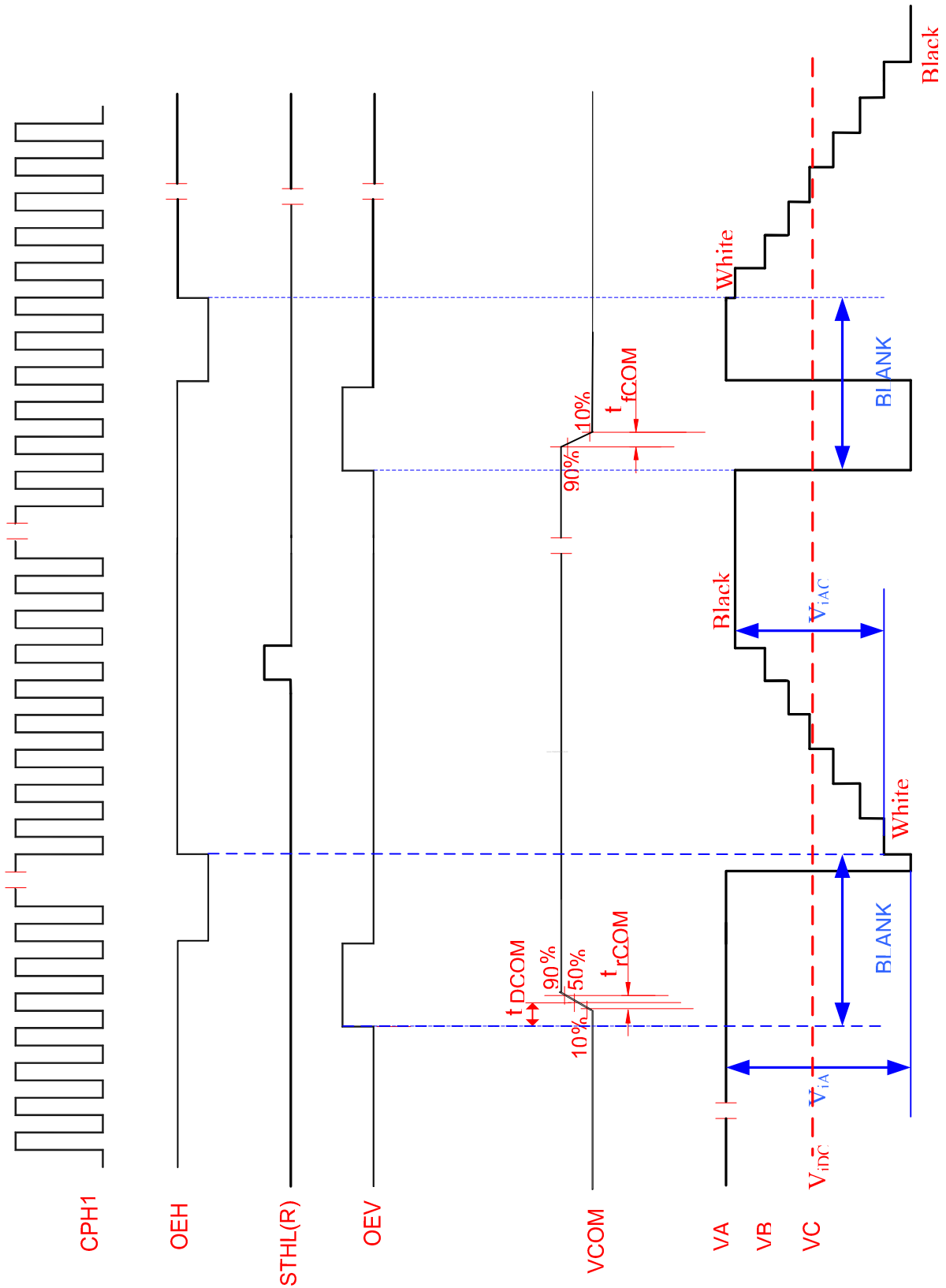

Fig.4 Horizontal timing

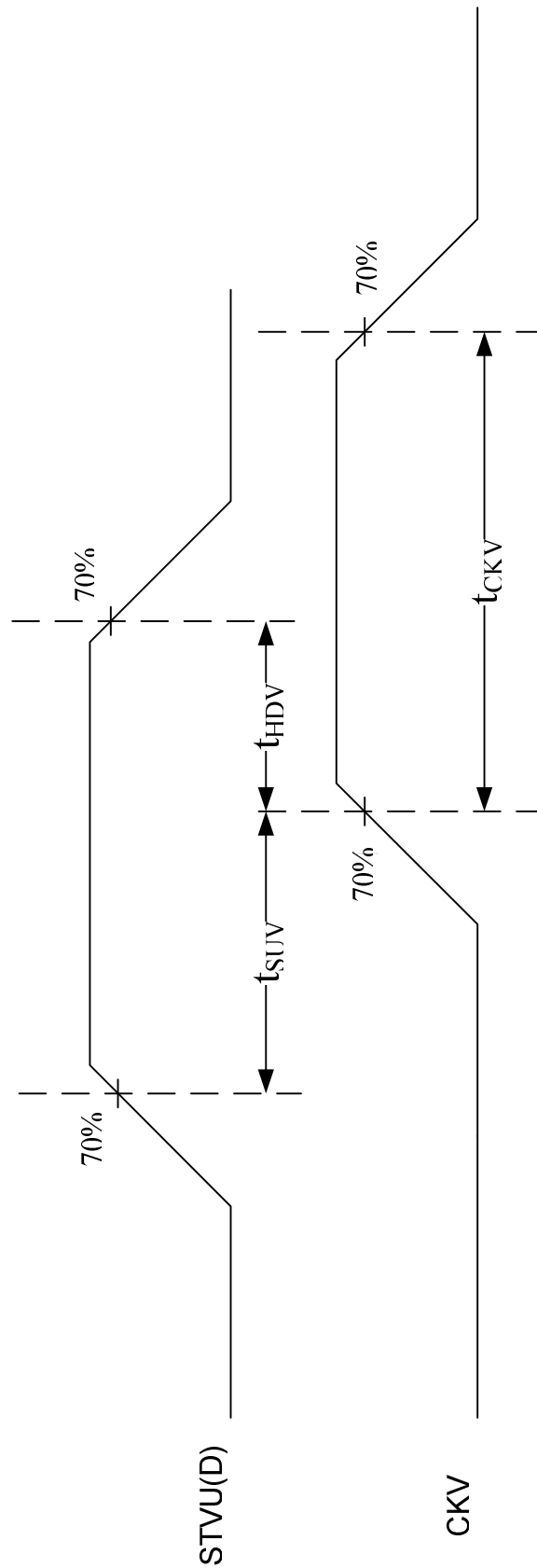

Fig.5 Vertical shift clock timing

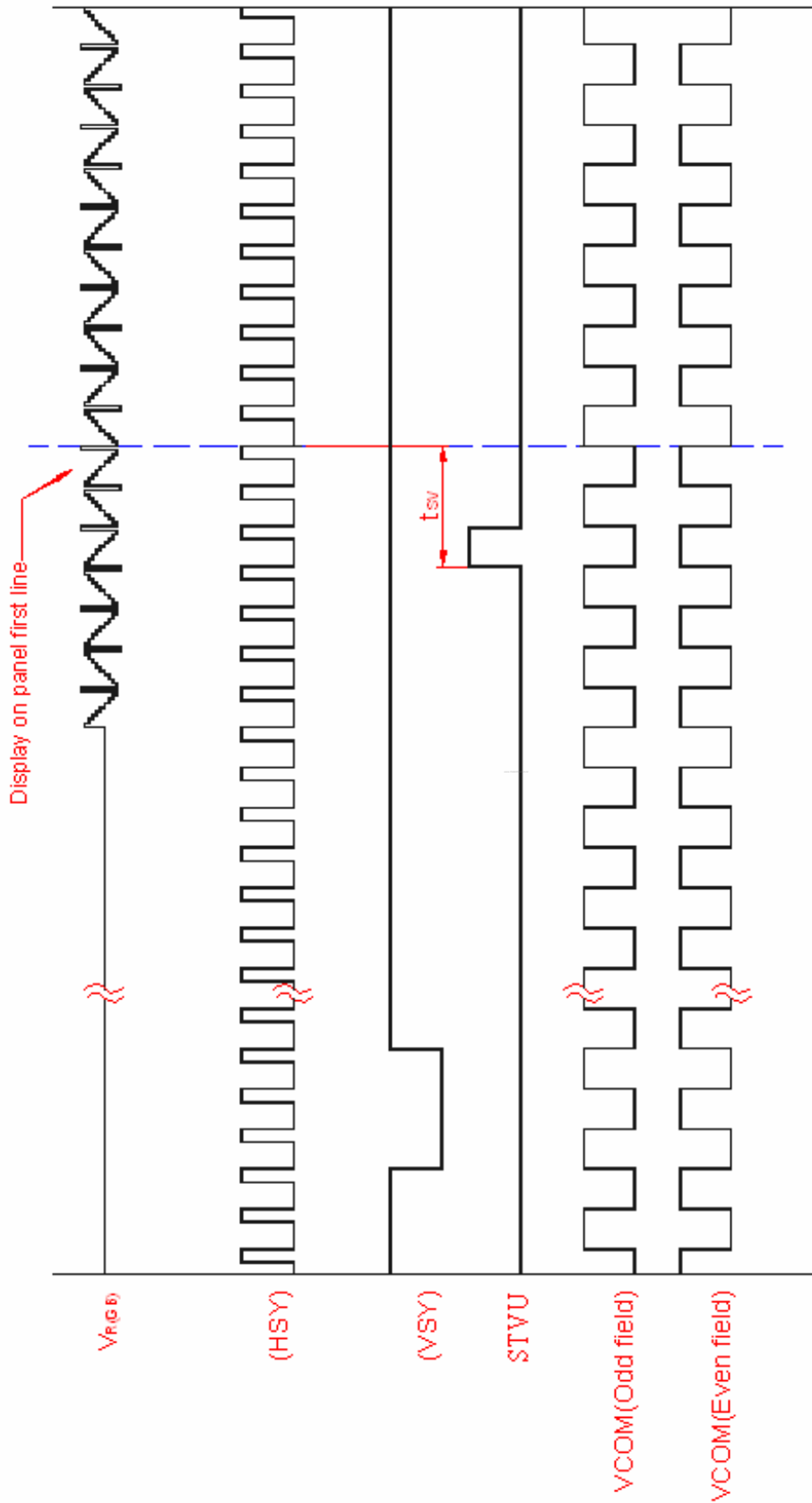
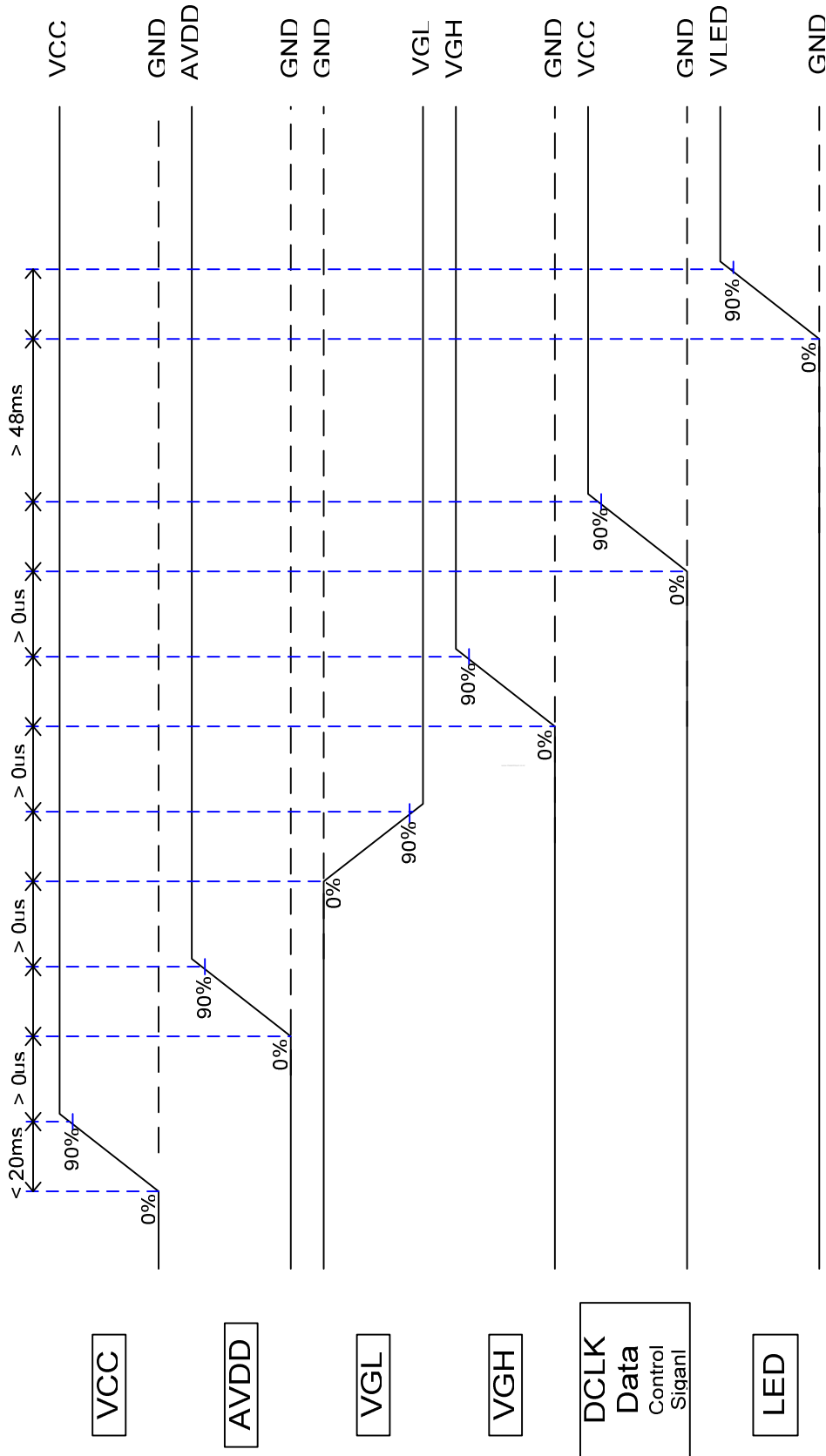
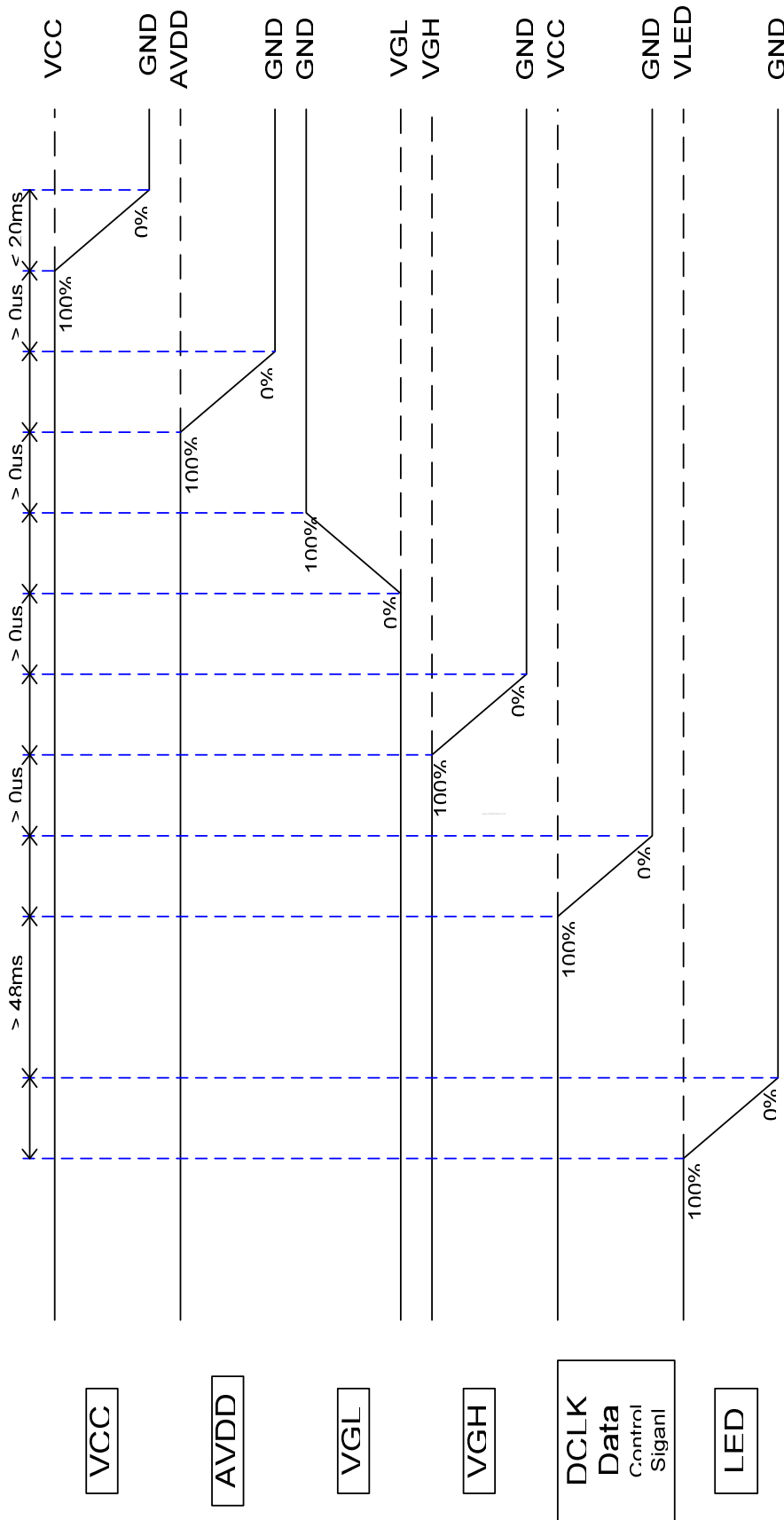

Fig.6 Vertical timing (From up to down)

5. Power On/Off Sequence (Only for reference)



Power On



Power Off

C. Optical specification (Note1, Note2)

Item		Symbol	Condition	Min.	Typ.	Max.	Unit	Remark
Response time	Rise	Tr	$\theta = 0^\circ$	-	15	50	ms	Note 3,5
	Fall	Tf		-	20	60	ms	
Contrast ratio		CR	At optimized Viewing angle	200	300	-		Note 4, 5
Viewing angle	Top		$CR \geq 10$	30	45	-	deg.	Note 5, 6
	Bottom			50	60	-		
	Left			50	60	-		
	Right			50	60	-		
Viewing angle	Top		$CR \geq 5$	40	50	-	deg.	Note 5, 6
	Bottom			60	70	-		
	Left			60	70	-		
	Right			60	70	-		
Brightness			$I_L=80mA, 25^\circ C$	400	500		cd/m^2	Note 7
White chromaticity	X	$\theta = 0^\circ$	0.26	0.33	0.36			
	Y	$\theta = 0^\circ$	0.28	0.34	0.38			

Note 1 : Ambient temperature =25°C , and LED $I_L = 80$ mA.

Note 2 :To be measured on the center area of panel with a viewing cone of 1°by Topcon luminance meter BM-5, after 15 minutes operation.

Note 3. Definition of response time:

The output signals of photo detector are measured when the input signals are changed from “black” to “white”(falling time) and from “white” to “black”(rising time), respectively. The response time is defined as the time interval between the 10% and 90% of amplitudes. Refer to figure as below.

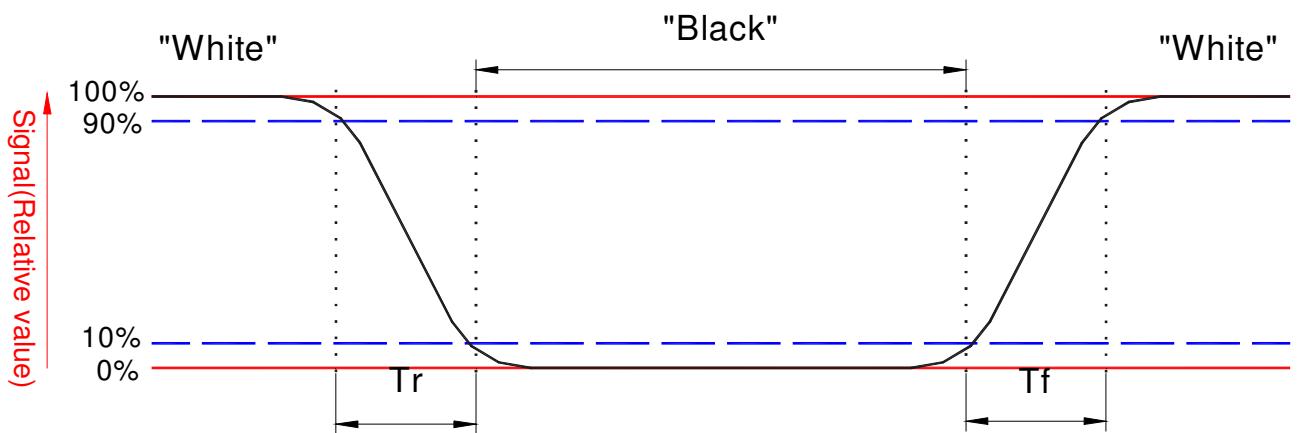

Note 4. Definition of contrast ratio:

Contrast ratio is calculated with the following formula.

$$\text{Contrast ratio (CR)} = \frac{\text{Photo detector output when LCD is at "White" state}}{\text{Photo detector output when LCD is at "Black" state}}$$

Note 5. White $V_i = V_{i50} + 1.5V$

Black $V_i = V_{i50} \pm 2.0V$

“±” means that the analog input signal swings in phase with V_{COM} signal.

“ \mp ” means that the analog input signal swings out of phase with V_{COM} signal.

V_{i50} : The analog input voltage when transmission is 50%

The 100% transmission is defined as the transmission of LCD panel when all the input terminals of module are electrically opened.

Note 6. Definition of viewing angle, Refer to figure as below.

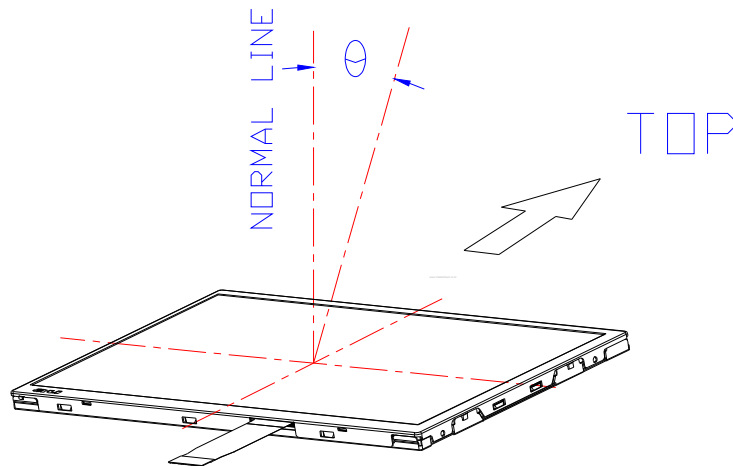

Note 7. Measured at the center area of the panel when all the input terminals of LCD panel are electrically opened.

D. Reliability test items(Note 3):

No.	Test items	Conditions	Remark
1	High temperature storage	Ta= 95°C 240Hrs	Note1
2	Low temperature storage	Ta= -40°C 240Hrs	
3	High temperature operation	Tp= 85°C 240Hrs	Note2
4	Low temperature operation	Ta= -30°C 240Hrs	
5	High temperature and high humidity	Tp= 60°C, 90% RH 240Hrs	Operation
6	Heat shock	-30°C ~85°C/200 cycles 1Hrs/cycle	Non-operation
7	Electrostatic discharge	±200V,200pF(0Ω), once for each terminal	Non-operation
8	Vibration	Frequency range : 8~33.3Hz Stoke : 1.3mm Sweep : 2.9G, 33.3 ~ 400Hz Cycle : 15 minutes 2 hours for each direction of X,Z 4 hours for Y direction	JIS D1601, A-10 condition A Note4
9	Mechanical shock	100G, 6ms, ±X,±Y,±Z 3 times for each direction	JIS C7021, A-7 Condition C
10	Vibration (with carton)	Random vibration: 0.015G ² /Hz from 5~200Hz -6dB/octave from 200~500Hz	IEC 68-34
11	Drop (with carton)	Height: 60cm 1 corner, 3 edges, 6 surfaces	JIS Z0202

Note1: Ta: Ambient temperature.

Note2: Tp: Panel Surface Temperature

Note3: In the standard conditions, there is not display function NG issue occurred. All the cosmetic specification is judged before the reliability stress.

Note 4: Cycle time for vibration is 15 minutes.



C061FW01 V0

Version : 0.3

Page : 20 /22

E. Packing form (TBD)

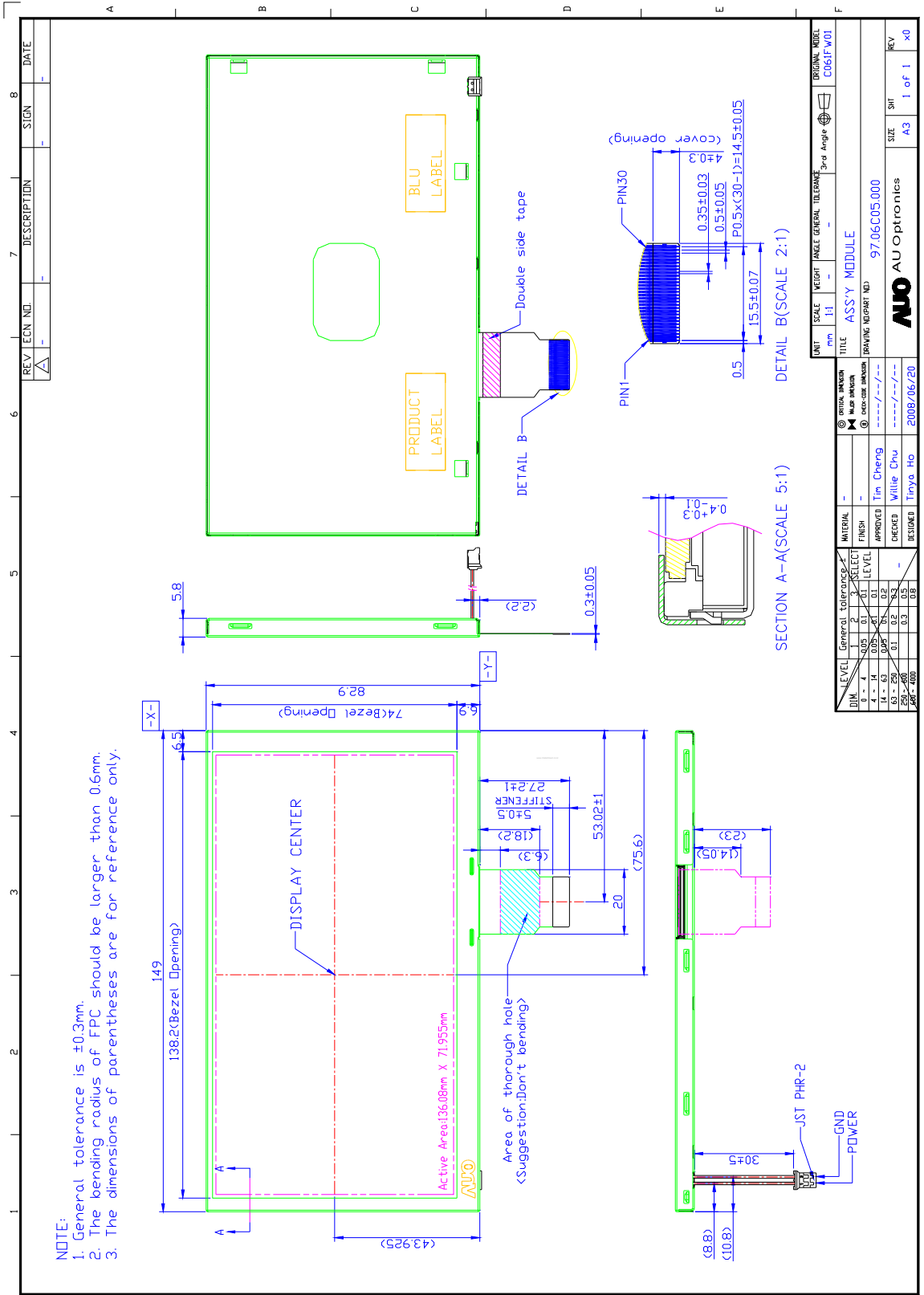

F. Mechanical Drawing -- Fig.7 Outline dimension of TFT-LCD module

G. MOD Setting

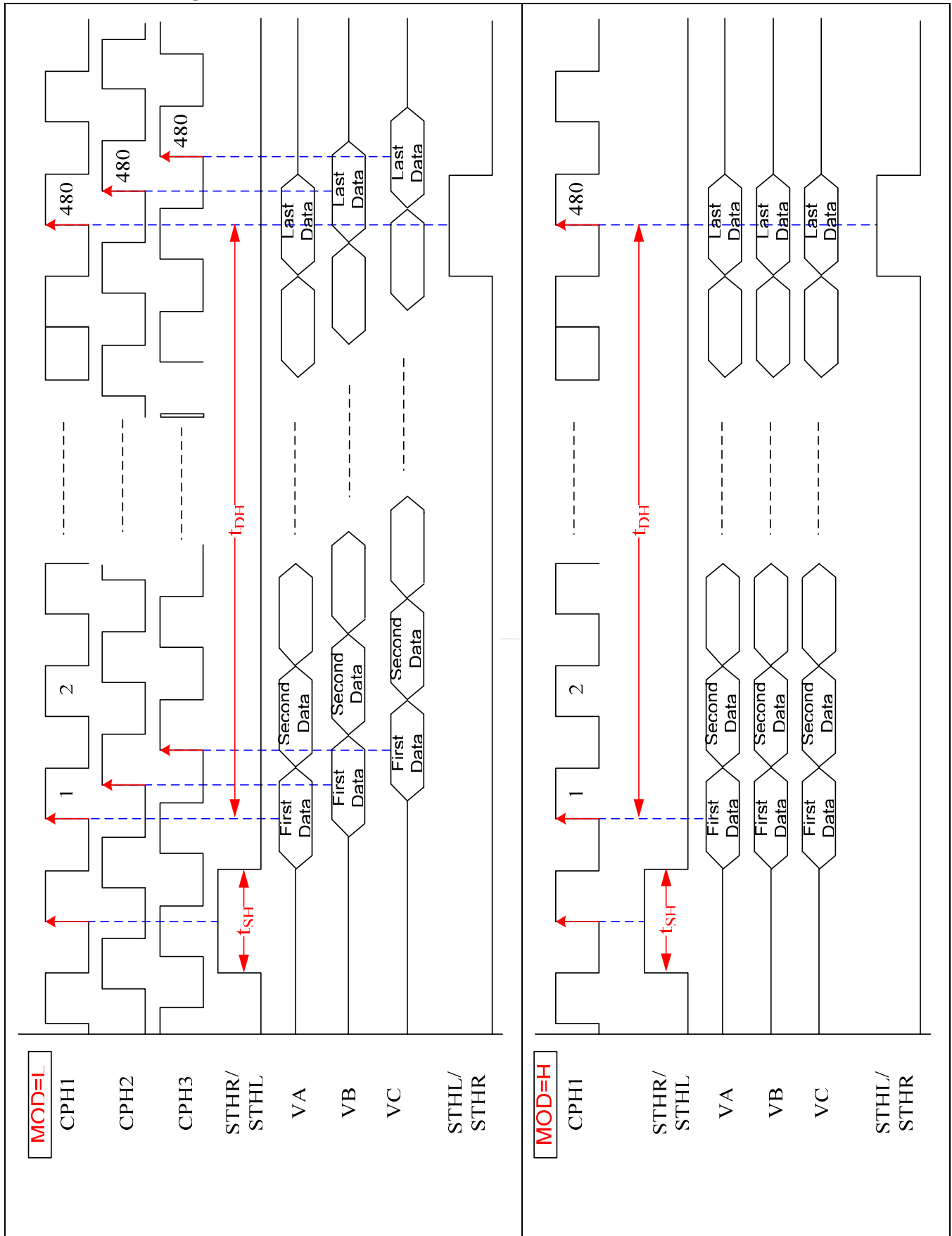

Fig.8 Select clock signal on latching R, G, B signals