

Helping Customers Innovate, Improve & Grow



## Description

OX-503 is a small form factor precision OXCO providing SC cut levels of reliability, aging and noise performance in a tiny footprint, making the OX-503 ideal for designs where high performance is required but space is limited.

## Features

- 6-Pin SMD package
- Fast warm-up
- TCXO replacement for better short term stability
- Frequency Range, 10 MHz to 52 MHz
- SC-Cut Design
- Standard freq.: 10; 19.44; 20; 24.576; 25; 30.72; 38.88; 40; 50; 51.2 MHz.

## Applications

- Base stations
- Test equipment
- Small Cells
- Military communication equipment
- Packet based timing (e.g. 1588).

## Performance Specifications

Parameter	Frequency Stabilities <sup>1</sup>				Condition	Options <sup>5</sup>
	Min	Typ	Max	Units		
vs. operating temperature range (referenced to +25°C)	-10		+10	ppb	-20 to +70°C	
	-25		+25	ppb	-20 to +70°C	
	-25		+25	ppb	-40 to +85°C	
	-50		+50	ppb	-40 to +85°C	
Initial tolerance	-0.2		+0.2	ppm	at time of shipment, nominal EFC	
vs. supply voltage change	-10		+10	ppb	$V_s \pm 5\%$ static	
vs. load change	-10		+10	ppb	Load $\pm 5\%$ static	
vs. aging / day	-1.0		+1.0	ppb	$\leq 40$ MHz after 30 days of operation	
vs. aging / day	-5.0		+5.0	ppb	$> 40$ MHz after 30 days of operation	
vs. aging / year	-100		+100	ppb	$\leq 40$ MHz after 30 days of operation	
vs. aging / year	-500		+500	ppb	$> 40$ MHz; after 30 days of operation	
Warm-up time			3	minutes	to $\pm 100$ ppb of final frequency (1 hour reading) @ +25°C	

# Performance Specifications

Supply Voltage (Vs)						
Parameter	Min	Typical	Max	Units	Condition	
Supply voltage (standard)	3.135	3.3	3.465	VDC		
Power consumption		2.1	2.2	Watts	during warm-up	
		0.8	1.1	Watts	steady state @ +25°C	
RF Output						
Signal [standard]	HCMOS					
Load		15		pF		
Signal Level (Vol)			0.4	VDC	with Vs=3.3V and 15pF Load	
Signal Level (Voh)	2.4			VDC	with Vs=3.3V and 15pF Load	
Duty Cycle	45		55	%	@ (Voh-Vol)/2	
Frequency Tuning (EFC)						
Tuning Range	Fixed OCXO; No adjust				Options <sup>5</sup>	
	±1.0		±3	ppm		with SC cut crystal
Linearity	10%					
Tuning Slope	Positive					
Control Voltage Range	0.0	1.4	2.8	VDC	with Vs=3.3V	
Additional Parameters						
Phase Noise <sup>3</sup>		-75	-70	dBc/Hz	1 Hz	@ 20MHz
		-105	-100	dBc/Hz	10 Hz	
		-125	-120	dBc/Hz	100 Hz	
		-140	-135	dBc/Hz	1 kHz	
		-148	-145	dBc/Hz	10 kHz	
Weight			4.0	g		
Processing & Packing	Handling & Processing Note					
Absolute Maximum Ratings						
Supply voltage (Vs)			4.0	V	with Vs=3.3VDC	
Output Load			50	pF		
Operable Temperature Range	-40		+85	°C		
Storage Temperature Range	-55		+85	°C		

# Outline Drawing / Enclosure

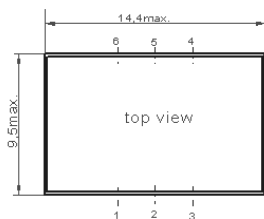

Dimensions in mm

OX-503		
Height "H"	cover material	
9.9	plastic	SC- Cut Version

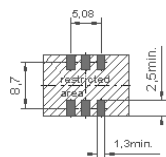
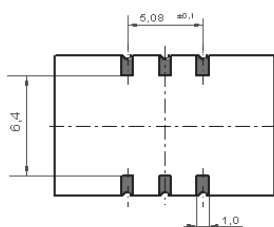
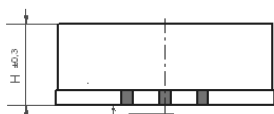

Padvorschlag  
land pattern  
recommendation

Pin Connections	
1	Electronic Frequency Control Input (EFC)
2	N.C
3	Ground (Case)
4	RF Output
5	N.C
6	Supply Voltage Input

# Standard Shipping Method (OX-503)

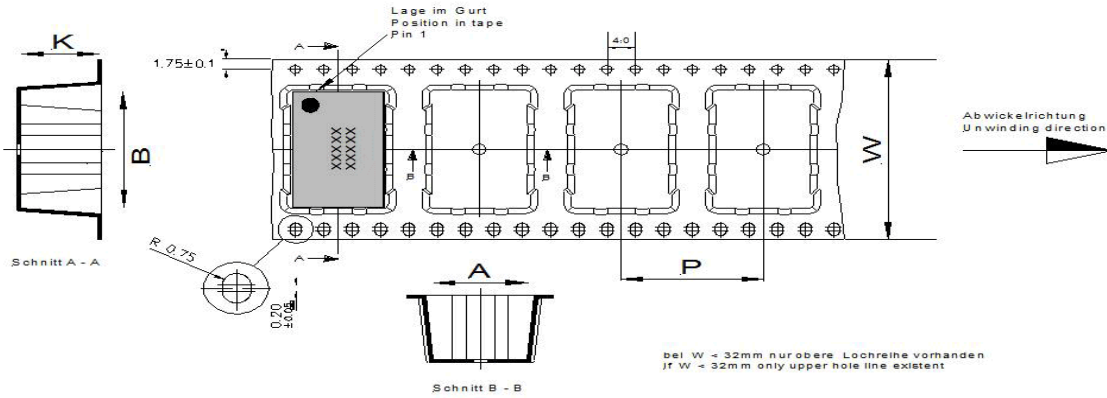

Maßangaben in mm :  
 A, B und K Maße vom Bauelement abhängig.  
 Fertigungstoleranzen entsprechen der DIN IEC 286-3

Dimension in mm :  
 A, B and K are dependent upon component dimensions,  
 production tolerance complying DIN IEC 286-3

All dimensions in millimetres unless otherwise stated.

Enclosure Type	Tape Width W (mm)	Quantity per meter	Quantity per reel	Dimension P
OX-5030 (9.9mm)	24	62.5	350	16

## Recommended Reflow Profile

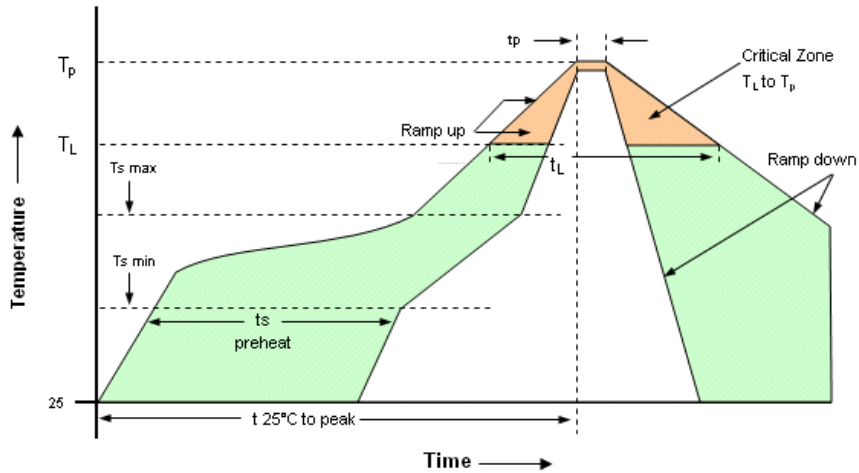

Profile Feature	Pb-Free Assembly/ Sn-Pb Assembly	Profile Feature	Pb-Free Assembly/ Sn-Pb Assembly
Average ramp-up rate ( $T_L$ to $T_p$ )	3°C/second max.	Time 25°C to Peak Temperature	8 minutes max.
Preheat -Temperature Min $T_{smin}$ -Temperature Min $T_{smax}$ -Time (min to max) $t_s$	150°C 200°C 60-180 seconds	Time maintained above -Temperature ( $T_L$ ) -Time ( $t_L$ )	217°C 60-150 seconds
$T_{smax}$ to $T_L$ -Ramp-up Rate	3°C/second max		
Time maintained above -Temperature ( $T_L$ ) -Time ( $t_L$ )	217°C 60-150 seconds	Time within 5°C of actual Peak Temperature ( $t_p$ )	20-40 seconds
Peak Temperature ( $T_p$ )	max 260°C	Ramp-down Rate	6°C/ second max

**Note:** All temperatures refer to topside of the package, measured on the package body surface.

## Ordering Information

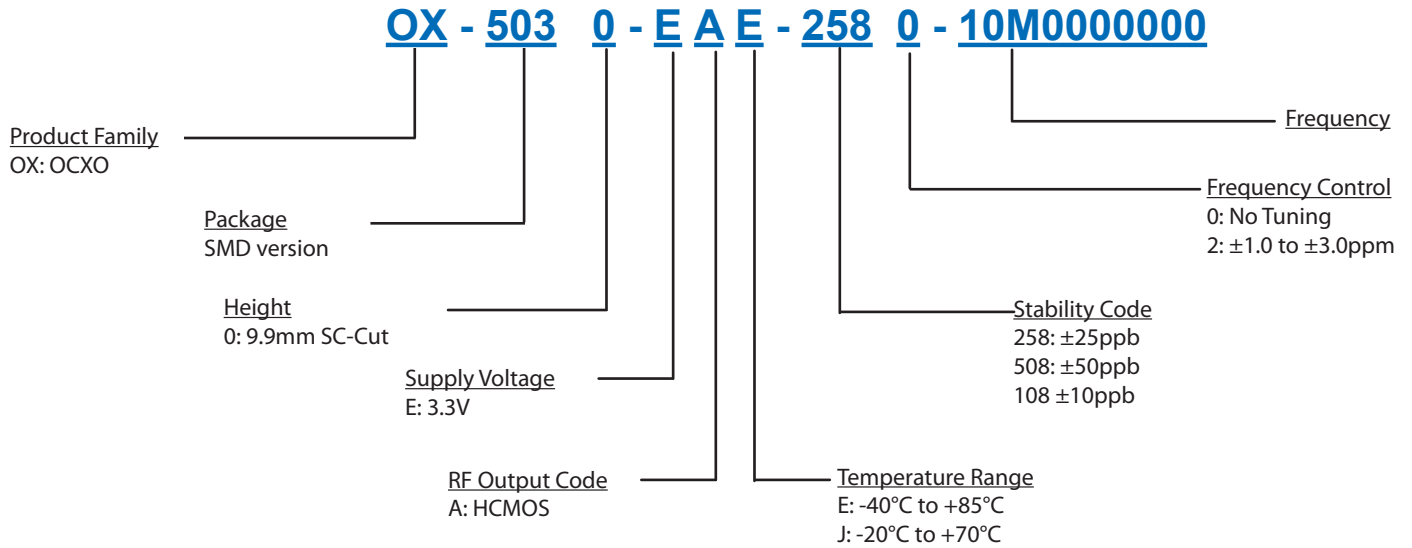

**Notes:**

1. Contact factory for improved stabilities or additional product options. Not all options and codes are available at all frequencies.
2. Unless other stated all values are valid after warm-up time and refer to typical conditions for supply voltage, frequency control voltage, load, temperature (25°C).
3. Phase noise degrades with increasing output frequency.
4. Subject to technical modification.
5. Contact factory for availability.

## For Additional Information, Please Contact

**USA:**

Vectron International  
267 Lowell Road  
Hudson, NH 03051  
Tel: 1.888.328.7661  
Fax: 1.888.329.8328

**Europe:**

Vectron International  
Landstrasse, D-74924  
Neckarbischofsheim, Germany  
Tel: +49 (0) 7268.801.100  
Fax: +49 (0) 7268.801.282

**Asia:**

Vectron International  
1589 Century Avenue, the 19th Floor  
Chamtime International Financial Center  
Shanghai, China  
Tel: 86.21.6081.2888  
Fax: 86.21.6163.3598

**Disclaimer**

Vectron International reserves the right to make changes to the product(s) and or information contained herein without notice. No liability is assumed as a result of their use or application. No rights under any patent accompany the sale of any such product(s) or information.

Rev: 15 Feb 2012