

WIDE BAND LOW NOISE AMPLIFIER GaAs MMIC

■ GENERAL DESCRIPTION

The NJG1145UA2 is a fully matched wide band low noise amplifier GaAs MMIC for digital TV and BS/CS applications. This amplifier covers VHF, UHF, and L bands.

To achieve wide dynamic range, the NJG1145UA2 offers high gain mode and low gain mode. Selecting high gain mode for weak signals, the NJG1145UA2 helps improve receiver sensitivity through high gain and low noise figure. Selecting low gain mode for strong signals, it bypasses LNA circuit to offer higher linearity.

In high gain mode, the NJG1145UA2 achieves high gain and high IIP3 across the band.

The ESD protection circuits are integrated into the MMIC. They achieve high ESD protection voltage.

An ultra-small and ultra-thin package of EPFFP6-A2 is adopted.

■ PACKAGE OUTLINE

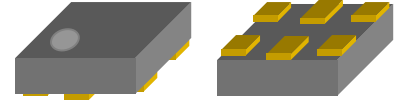

NJG1145UA2

■ FEATURES

- Wide operating frequency range 90MHz~2150MHz
- Low voltage operation 2.8V typ.
- External components count 3pcs. (capacitor: 2pcs, inductor: 1pc)
- Small package size EPFFP6-A2 (package size: 1.0mmx1.0mmx0.37mm typ.)

[High gain mode]

- Current consumption 20mA typ.
- High gain +15.0dB typ.
- Low noise figure 1.5dB typ.

[Low gain mode]

- Low current consumption 11μA typ.
- Gain(Low loss) -1.0dB typ.

■ PIN CONFIGURATION

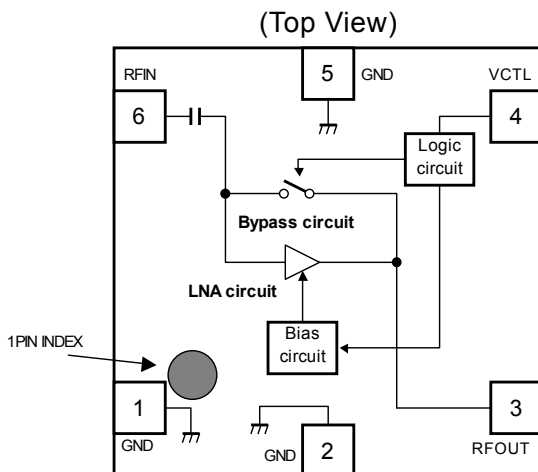

Pin Connection

1. GND
2. GND
3. RFOUT
4. VCTL
5. GND
6. RFIN

■ TRUTH TABLE "H"= $V_{CTL(H)}$ "L"= $V_{CTL(L)}$

V_{CTL}	LNA ON	Bypass	LNA mode
H	ON	OFF	High Gain mode
L	OFF	ON	Low Gain mode

Note: Specifications and description listed in this datasheet are subject to change without notice.

NJG1145UA2

■ ABSOLUTE MAXIMUM RATINGS

$T_a=+25^{\circ}\text{C}$, $Z_s=Z_l=50\text{ ohm}$

PARAMETER	SYMBOL	CONDITIONS	RATINGS	UNITS
Supply voltage	V_{DD}		5.0	V
Control voltage	V_{CTL}		5.0	V
Input power	P_{IN}	$V_{DD}=2.8\text{V}$	+15	dBm
Power dissipation	P_D	4-layer FR4 PCB with through-hole (101.5x114.5mm), $T_j=150^{\circ}\text{C}$	590	mW
Operating temperature	T_{opr}		-40~+85	$^{\circ}\text{C}$
Storage temperature	T_{stg}		-55~+150	$^{\circ}\text{C}$

■ ELECTRICAL CHARACTERISTICS1 (DC CHARACTERISTICS)

General conditions: $V_{DD}=2.8\text{V}$, $T_a=+25^{\circ}\text{C}$, $Z_s=Z_l=50\text{ ohm}$

PARAMETERS	SYMBOL	CONDITIONS	MIN	TYP	MAX	UNITS
Operating voltage	V_{DD}		2.3	2.8	3.6	V
Control voltage (High)	$V_{CTL(H)}$		1.3	1.8	3.6	V
Control voltage (Low)	$V_{CTL(L)}$		0.0	0.0	0.5	V
Operating current1	I_{DD1}	RF OFF, $V_{CTL}=1.8\text{V}$	-	20.0	27.0	mA
Operating current2	I_{DD2}	RF OFF, $V_{CTL}=0\text{V}$	-	11.0	25.0	μA
Control current	I_{CTL}	RF OFF, $V_{CTL}=1.8\text{V}$	-	6.0	10.0	μA

■ ELECTRICAL CHARACTERISTICS2 (High Gain mode)

Conditions: freq=90~2150MHz, $V_{DD}=2.8V$, $V_{CTL}=1.8V$, $T_a=+25^{\circ}C$, $Z_s=Z_l=50\text{ ohm}$

PARAMETERS	SYMBOL	CONDITIONS	MIN	TYP	MAX	UNITS
Small signal gain1	Gain1	Exclude PCB, connector losses*1	12.0	15.0	18.0	dB
Noise figure1	NF1	Exclude PCB, connector losses*2	-	1.5	2.3	dB
Input power 1dB gain compression1	$P_{-1dB(IN)1}$		-5.0	+0.0	-	dBm
Input 3rd order intercept point1	IIP3_1	$f_1=freq$, $f_2=freq+100kHz$, $P_{IN}=-26dBm$	+2.0	+10.0	-	dBm
2nd order IMD1	IM2_1	$f_1=200MHz$, $f_2=500MHz$, $f_{meas}=700MHz$, $P_{IN1}=P_{IN2}=-15dBm$ *3	20.0	28.0	-	dB
3rd order IMD1	IM3_1	$f_1=600MHz$, $f_2=650MHz$, $f_{meas}=700MHz$, $P_{IN1}=P_{IN2}=-15dBm$ *3	35.0	45.0	-	dB
Isolation	ISL	S12	-	-19.0	-15.0	dB
RF IN VSWR1	VSWRi1		-	2.2	3.2	-
RF OUT VSWR1	VSWRo1		-	1.5	2.2	-

*1 Input & output PCB and connector losses: 0.037dB(90MHz), 0.092dB(620MHz), 0.274dB(2150MHz)

*2 Input PCB and connector losses: 0.019dB(90MHz), 0.046dB(620MHz), 0.122dB(2150MHz)

*3 Definitions of IM2 and IM3.

Pout(dBm)

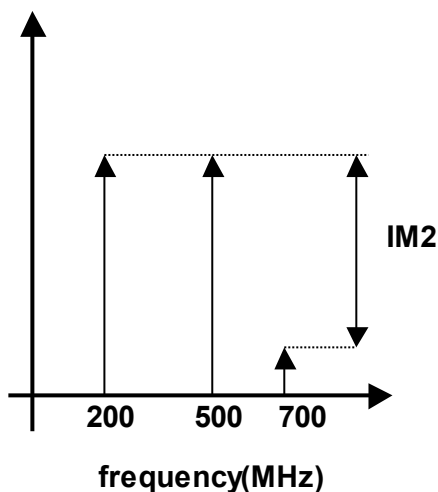

Pout(dBm)

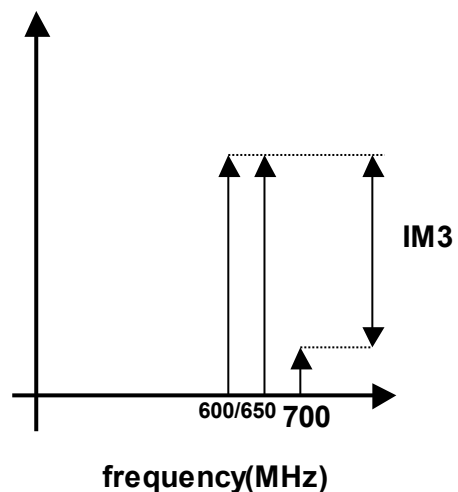

NJG1145UA2

■ ELECTRICAL CHARACTERISTICS3 (Low Gain mode)

Conditions: freq=90~2150MHz, $V_{DD}=2.8V$, $V_{CTL}=0V$, $T_a=+25^{\circ}C$, $Z_s=Z_l=50\text{ ohm}$

PARAMETERS	SYMBOL	CONDITIONS	MIN	TYP	MAX	UNITS
Small signal gain ²	Gain ₂	Exclude PCB, connector losses* ¹	-6.0	-1.0	-	dB
Input power at 1dB gain compression ²	$P_{-1dB(IN)2}$		+10.0	+15.0	-	dBm
Input 3rd order intercept point ²	IIP _{3_2}	f ₁ =freq, f ₂ =freq+100kHz, P _{IN} =-6dBm	+20.0	+30.0	-	dBm
2nd order IMD ²	IMD _{2_2}	f ₁ =200MHz, f ₂ =500MHz f _{meas} =700MHz, P _{IN1} =P _{IN2} =-8dBm * ³	55.0	66.0	-	dB
3rd order IMD ²	IMD _{3_2}	f ₁ =600MHz, f ₂ =650MHz f _{meas} =700MHz, P _{IN1} =P _{IN2} =-8dBm * ³	65.0	75.0	-	dB
RF IN VSWR ²	VSWR _{i2}		-	1.5	4.0	-
RF OUT VSWR ²	VSWR _{o2}		-	1.5	4.0	-

*¹ Input & output PCB and connector losses: 0.037dB(90MHz), 0.092dB(620MHz), 0.274dB(2150MHz)

*³ Definitions of IM₂ and IM₃.

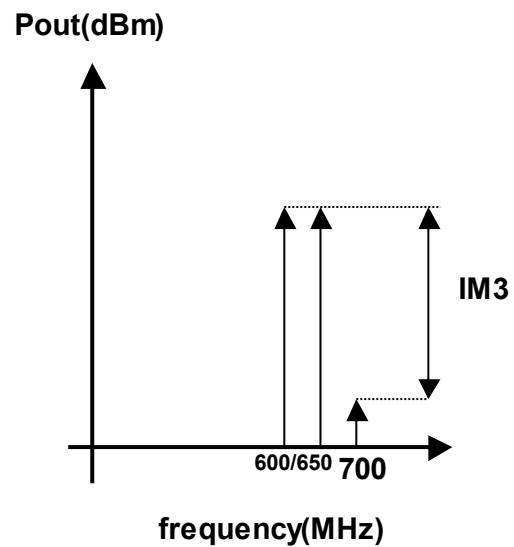
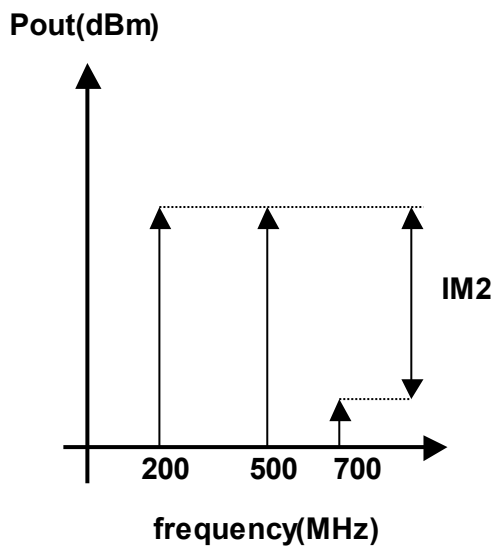

■ TERMINAL INFORMATION

No.	SYMBOL	DESCRIPTION
1	GND	Ground terminal. This terminal should be connected to the ground plane as close as possible for excellent RF performance.
2	GND	Ground terminal. This terminal should be connected to the ground plane as close as possible for excellent RF performance.
3	RFOUT	RF output terminal. This terminal doubles as the drain terminal of the LNA. Please connect this terminal to the power supply(VDD) via inductor(L1).
4	VCTL	Control voltage terminal.
5	GND	Ground terminal. This terminal should be connected to the ground plane as close as possible for excellent RF performance.
6	RFIN	RF input terminal. This IC integrates an input DC blocking capacitor.

NJG1145UA2

■ ELECTRICAL CHARACTERISTICS (High Gain mode)

Conditions: $V_{DD}=2.8V$, $V_{CTL}=1.8V$, $T_a=25^\circ C$, $Z_s=Z_l=50\text{ ohm}$, with application circuit

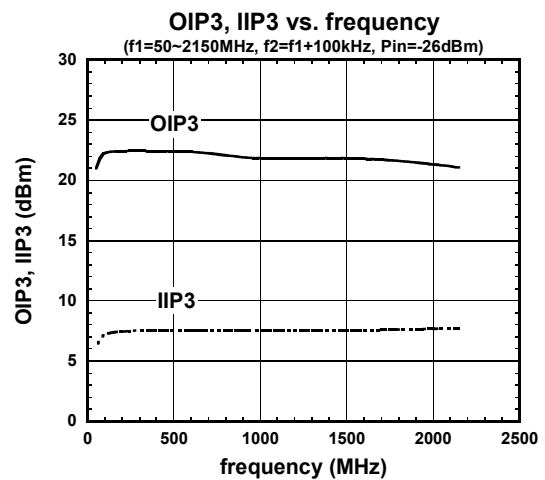
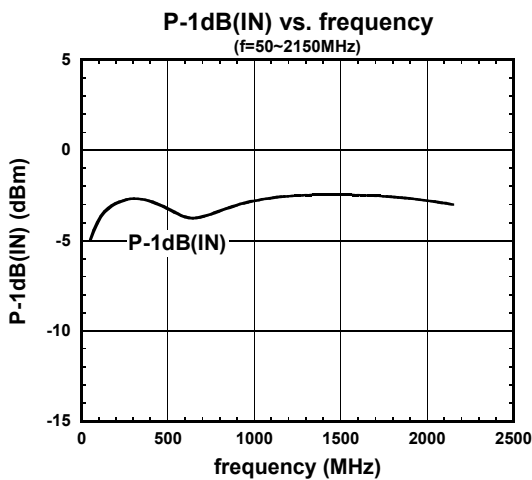
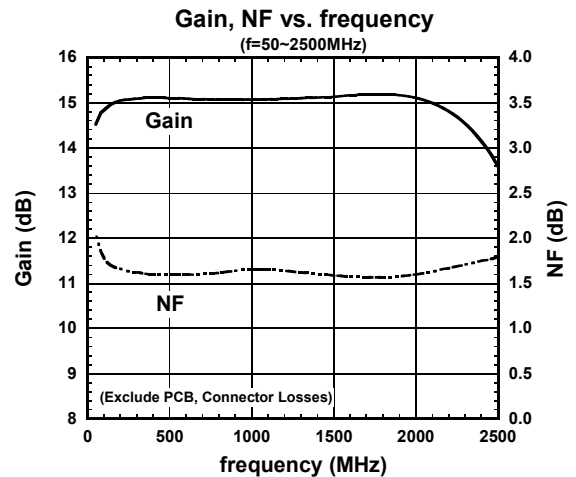
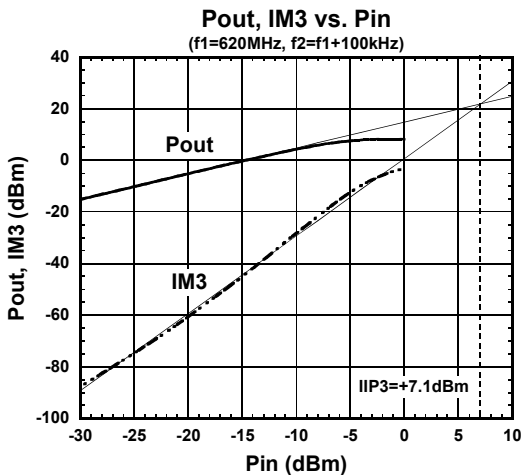
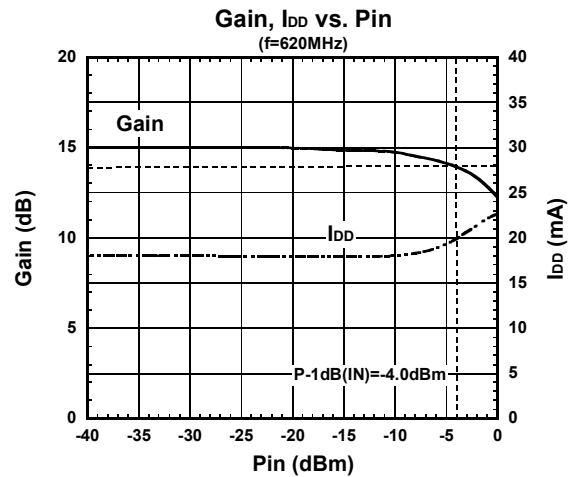
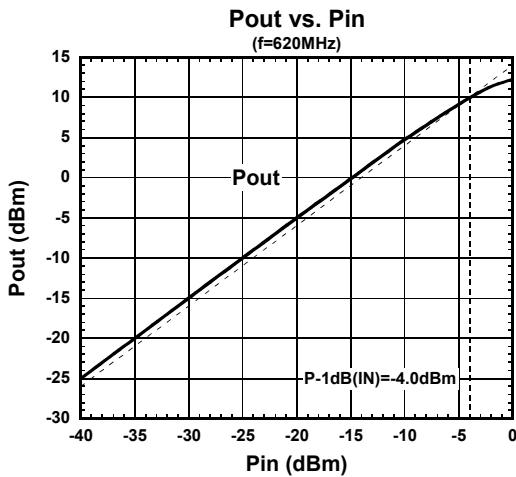

■ ELECTRICAL CHARACTERISTICS (High Gain mode)

Conditions: $V_{CTL}=1.8V$, $T_a=25^\circ C$, $Z_s=Z_l=50\text{ ohm}$, with application circuit

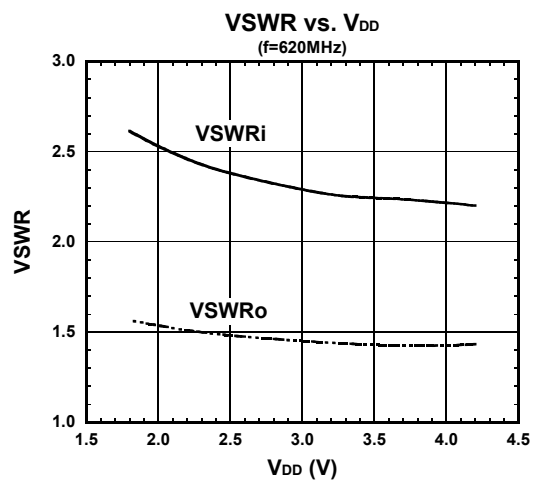
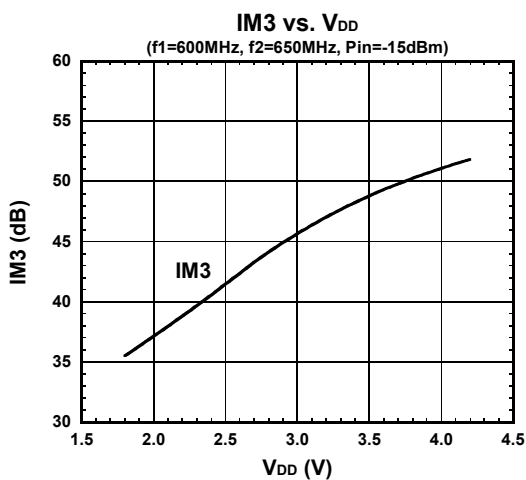
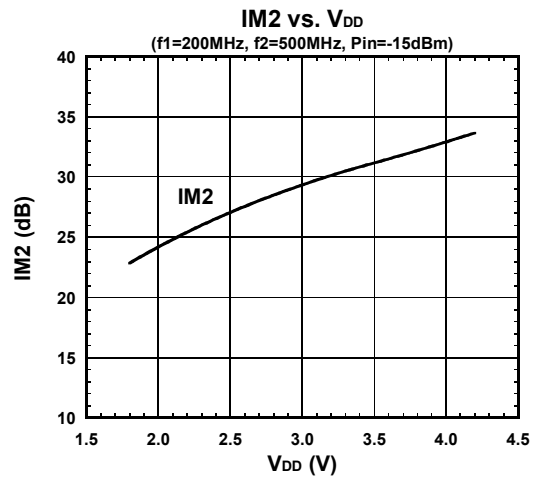
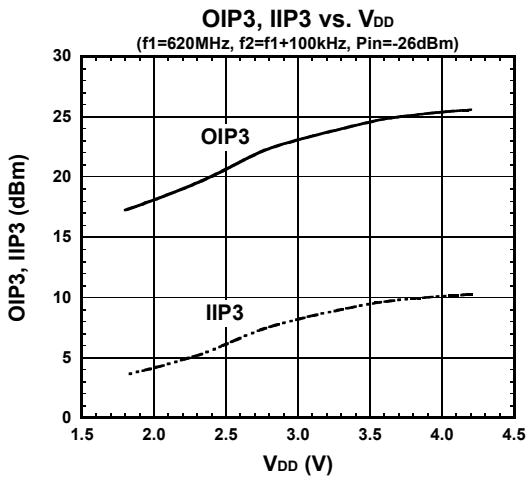
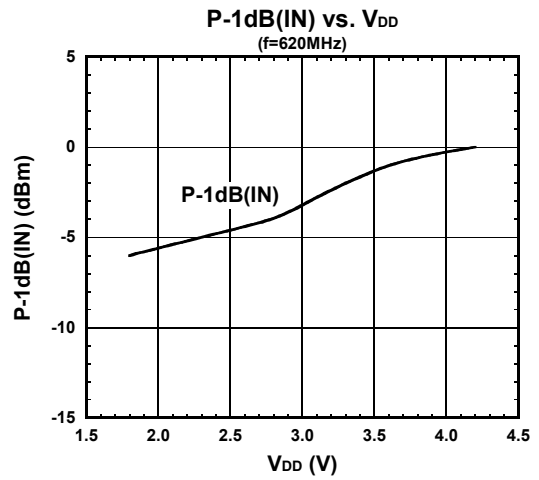
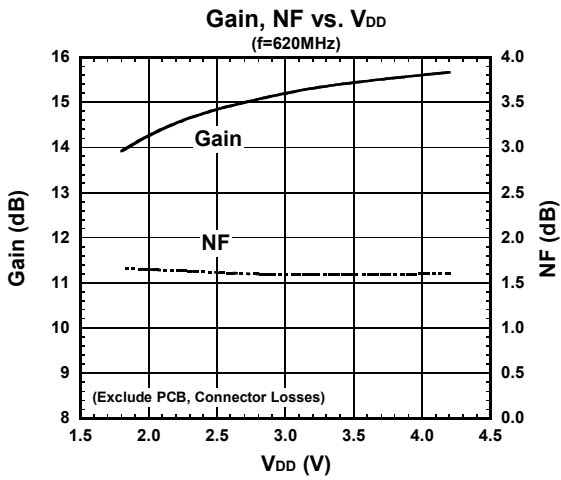

NJG1145UA2

■ ELECTRICAL CHARACTERISTICS (High Gain mode)

Conditions: $V_{CTL}=1.8V$, $T_a=25^{\circ}C$, $Z_s=Z_l=50\text{ ohm}$, with application circuit

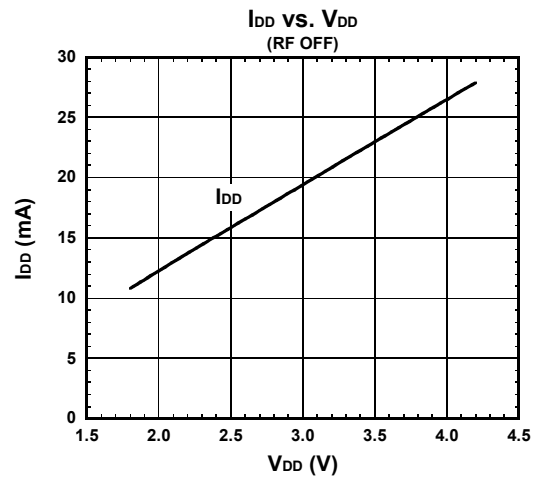
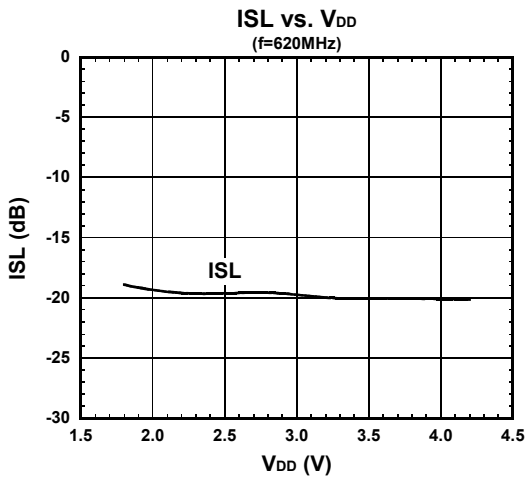

■ ELECTRICAL CHARACTERISTICS (High Gain mode)

Conditions: $V_{DD}=2.8V$, $V_{CTL}=1.8V$, $Z_s=Z_l=50\text{ ohm}$, with application circuit

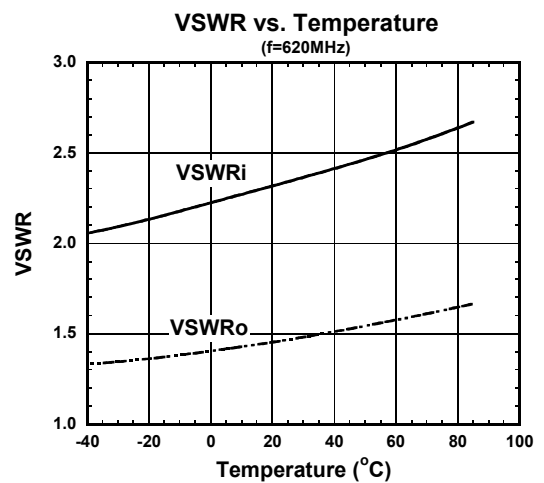
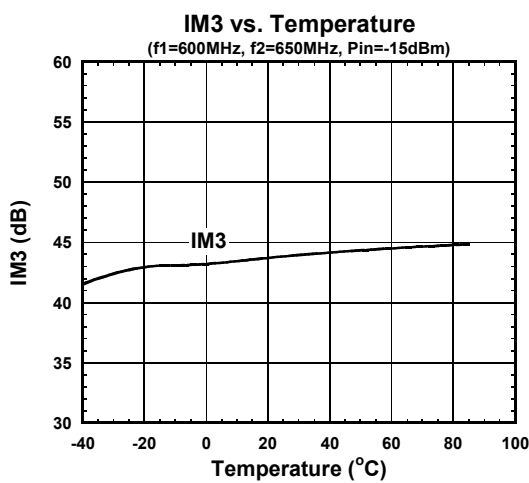
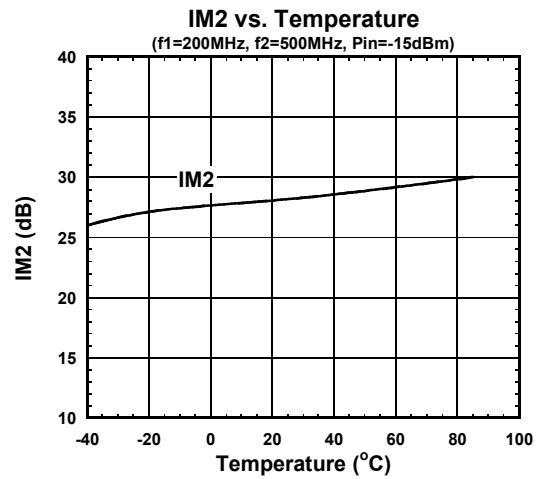
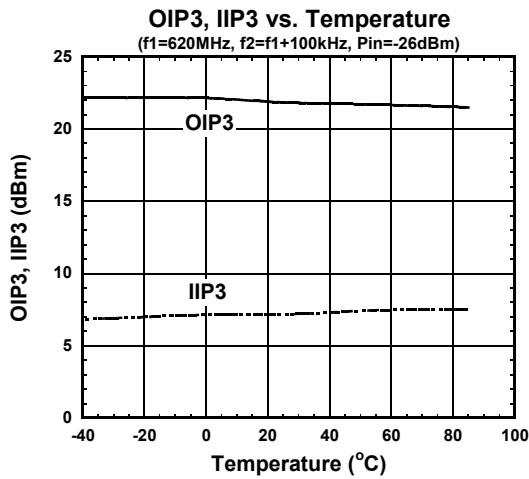
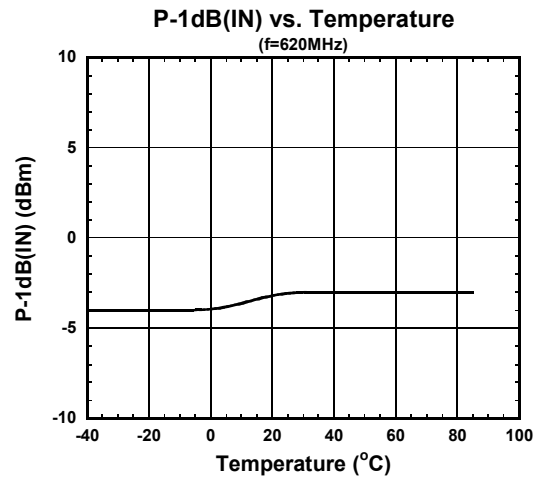
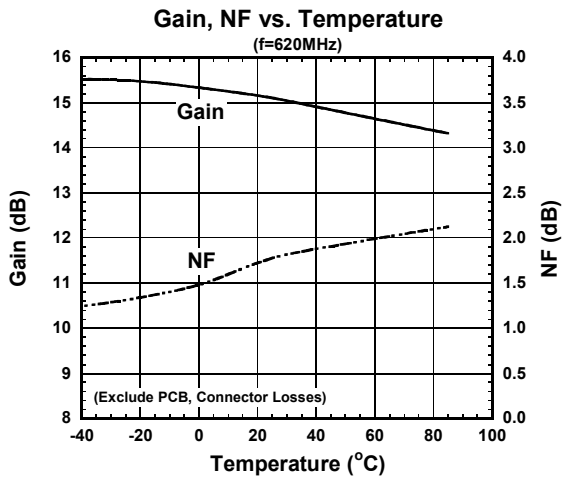

NJG1145UA2

■ ELECTRICAL CHARACTERISTICS (High Gain mode)

Conditions: $V_{DD}=2.8V$, $V_{CTL}=1.8V$, $Z_s=Z_l=50\text{ ohm}$, with application circuit

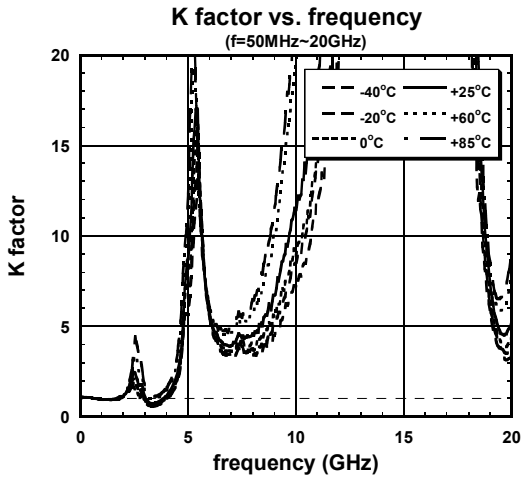
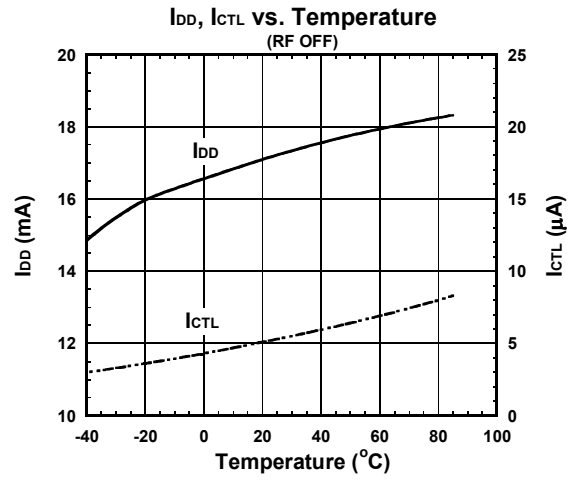
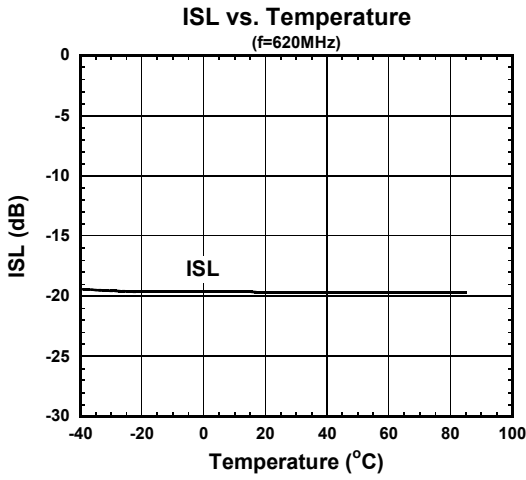

■ ELECTRICAL CHARACTERISTICS (High Gain mode)

Conditions: $V_{DD}=2.8V$, $V_{CTL}=1.8V$, $T_a=25^\circ C$, $Z_s=Z_l=50\ \text{ohm}$, with application circuit

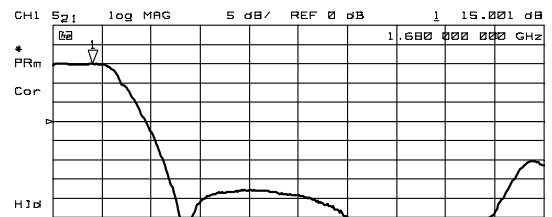
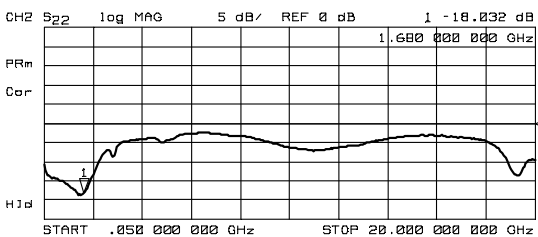
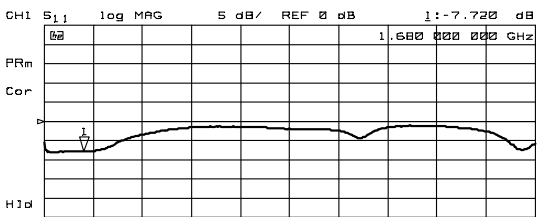
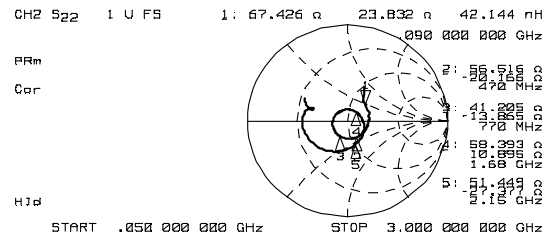
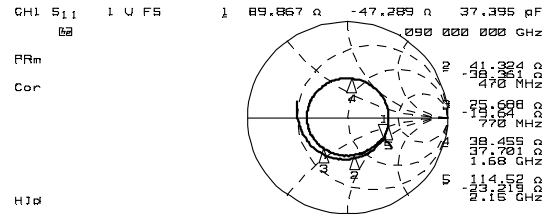
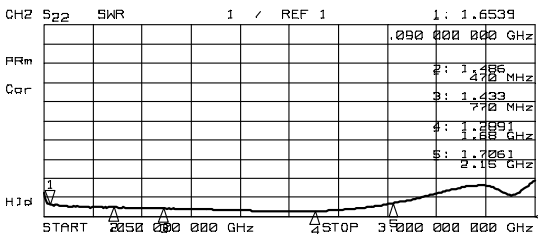
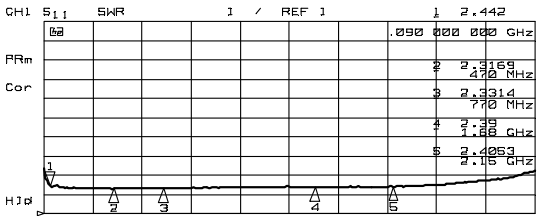
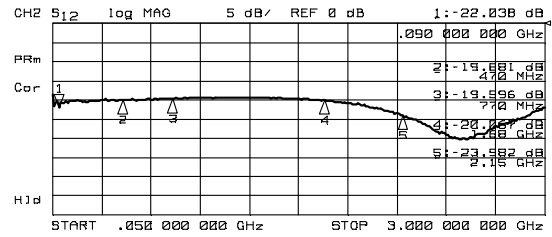
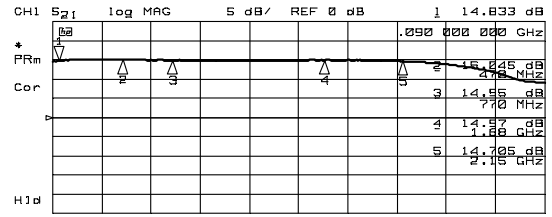
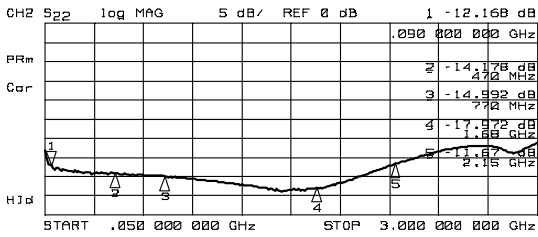
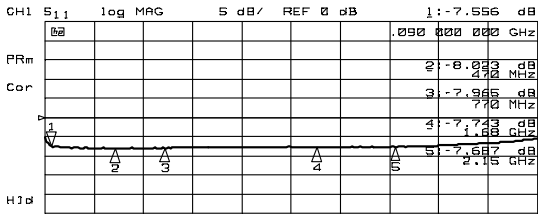

NJG1145UA2

■ ELECTRICAL CHARACTERISTICS (Low Gain mode)

Conditions: $V_{DD}=2.8V$, $V_{CTL}=0V$, $T_a=25^\circ C$, $Z_s=Z_l=50\text{ ohm}$, with application circuit

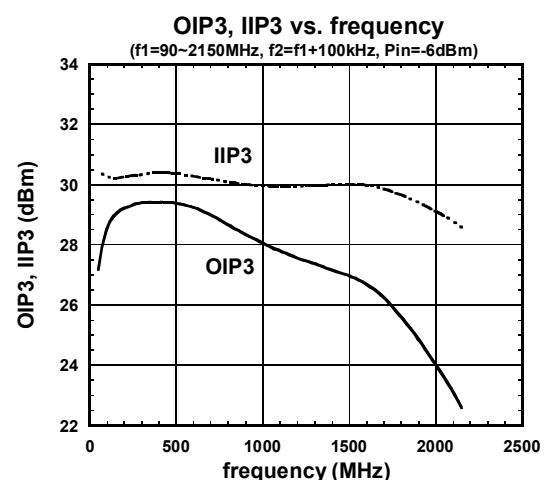
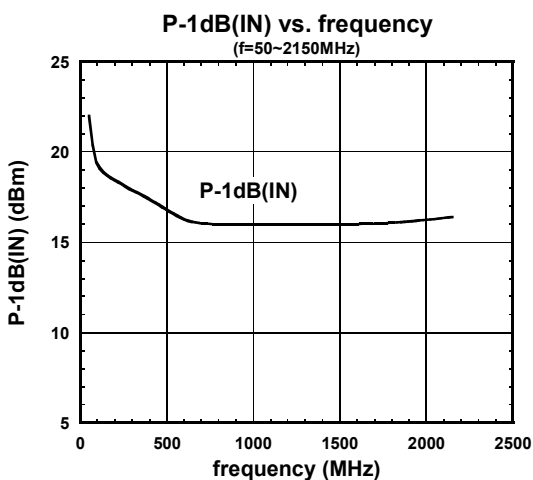
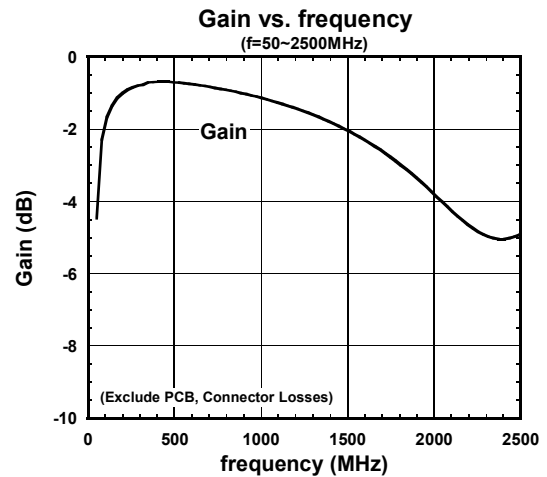
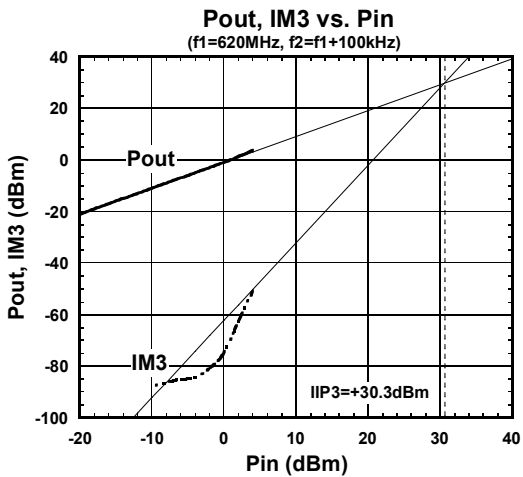
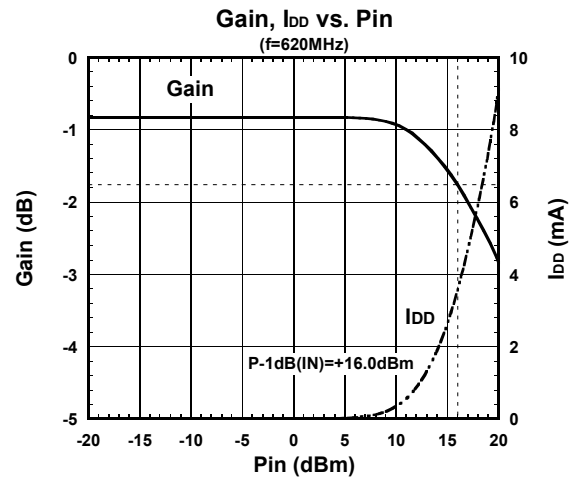
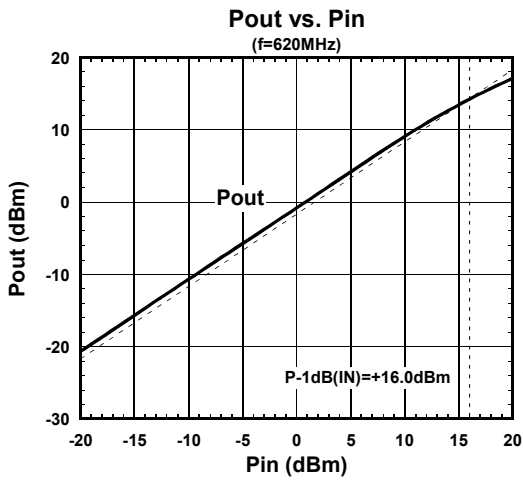

■ ELECTRICAL CHARACTERISTICS (Low Gain mode)

Conditions: $V_{CTL}=0V$, $T_a=25^\circ C$, $Z_s=Z_l=50\text{ ohm}$, with application circuit

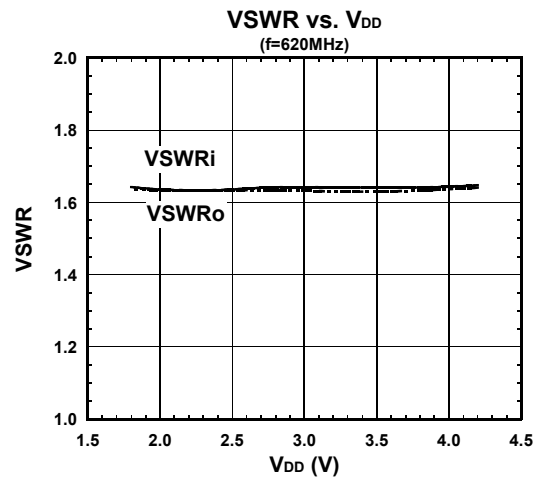
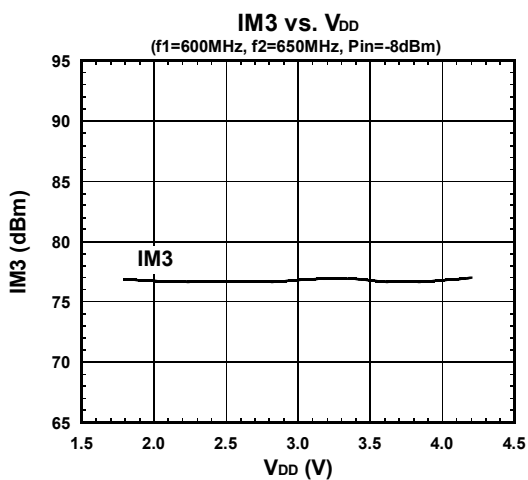
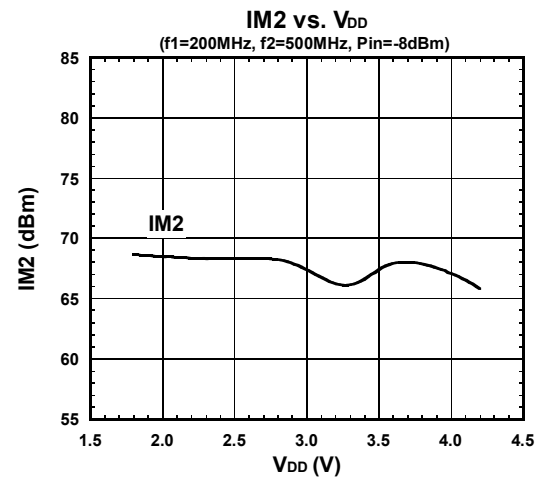
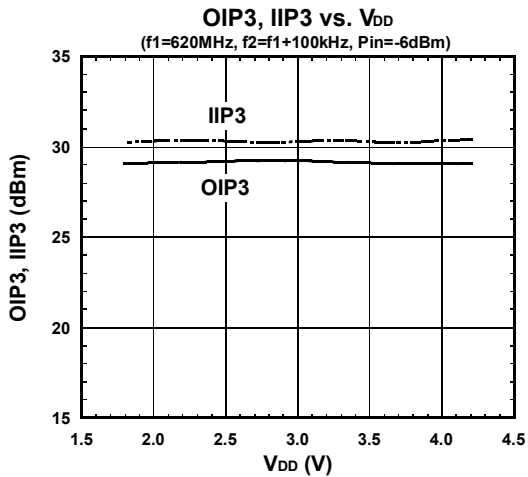
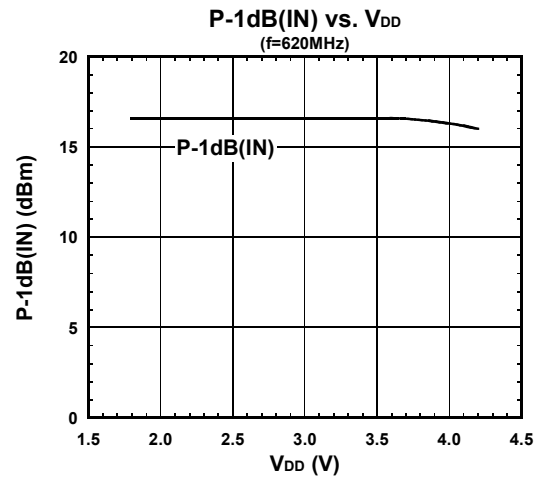
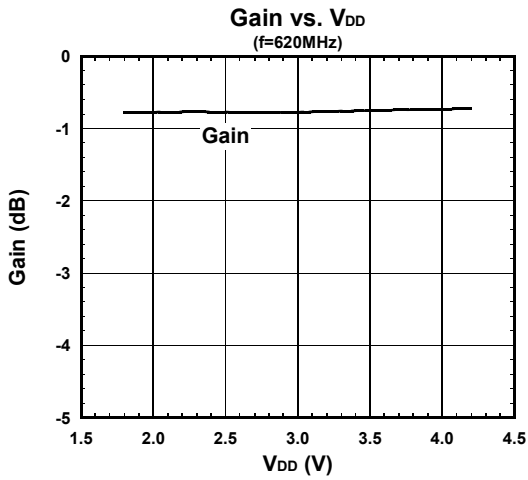

NJG1145UA2

■ ELECTRICAL CHARACTERISTICS (Low Gain mode)

Conditions: $V_{CTL}=0V$, $T_a=25^\circ C$, $Z_s=Z_l=50\text{ ohm}$, with application circuit

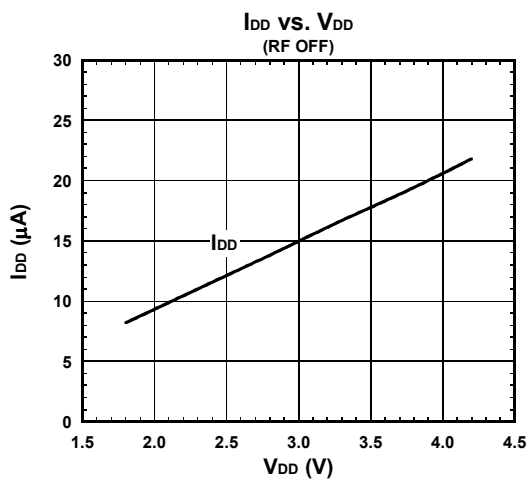

■ ELECTRICAL CHARACTERISTICS (Low Gain mode)

Conditions: $V_{DD}=2.8V$, $V_{CTL}=0V$, $Z_s=Z_l=50\text{ ohm}$, with application circuit

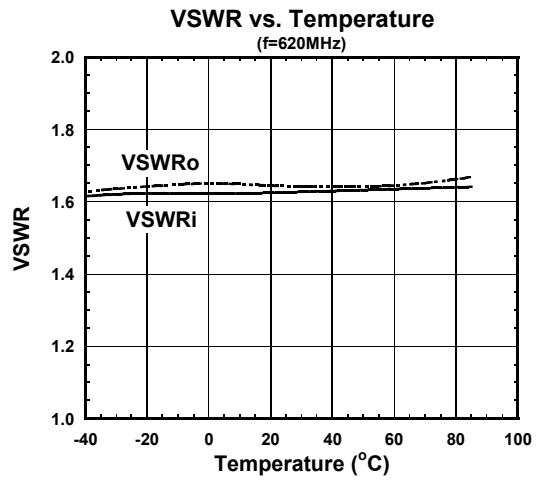
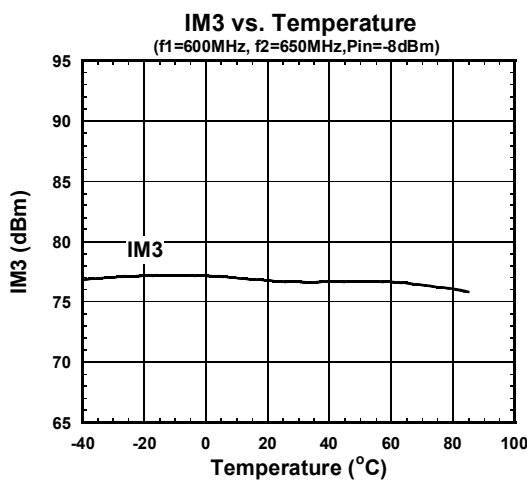
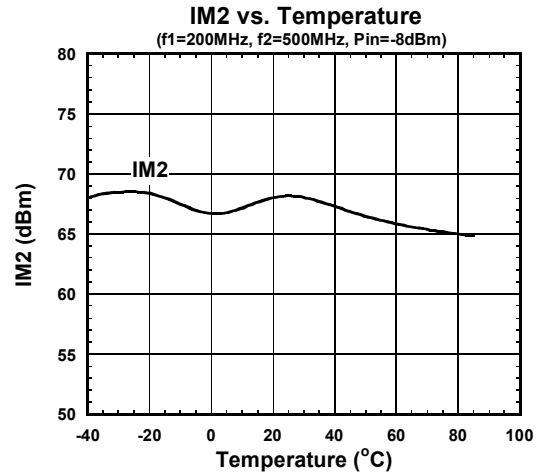
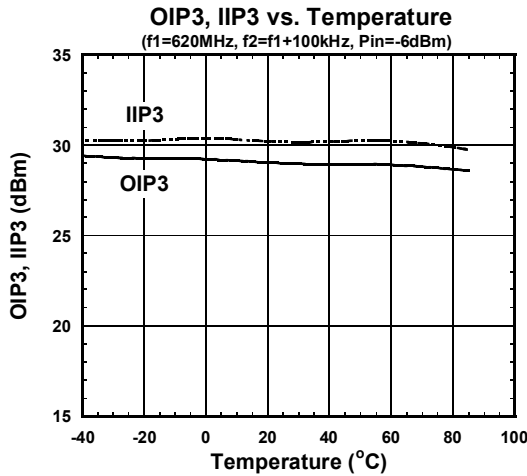
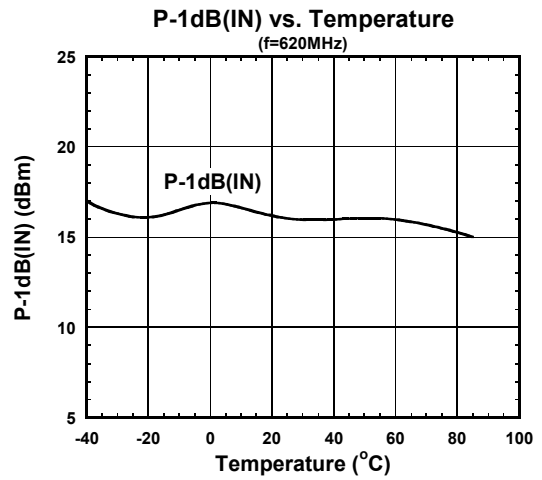
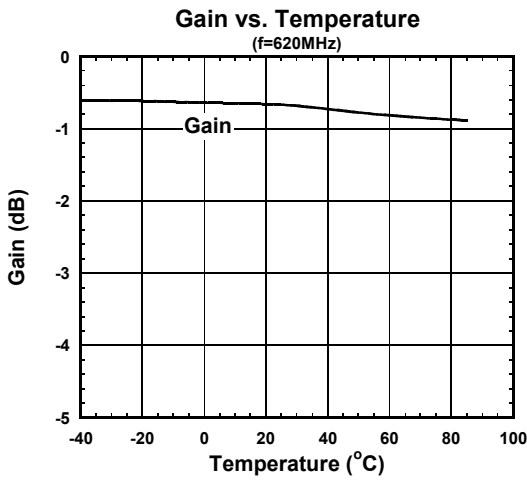

NJG1145UA2

■ ELECTRICAL CHARACTERISTICS (Low Gain mode)

Conditions: $V_{DD}=2.8V$, $V_{CTL}=0V$, $Z_s=Z_l=50\text{ ohm}$, with application circuit

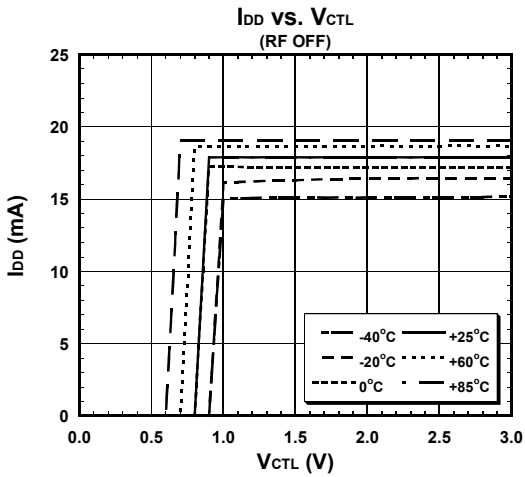
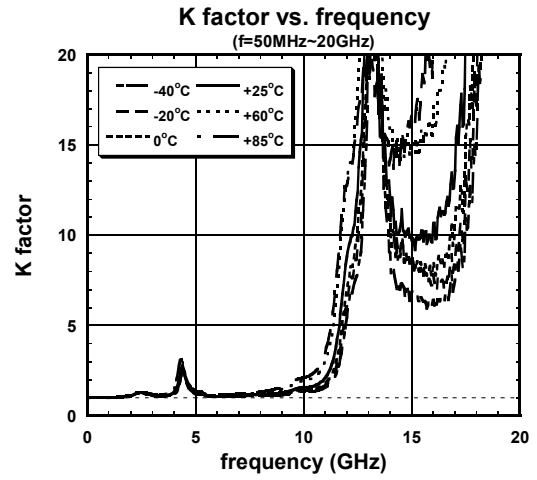
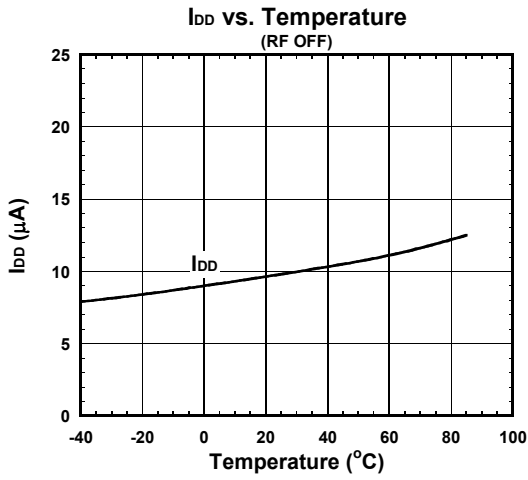

■ ELECTRICAL CHARACTERISTICS (Low Gain mode)

Conditions: $V_{DD}=2.8V$, $V_{CTL}=0V$, $T_a=25^\circ C$, $Z_s=Z_l=50\ \text{ohm}$, with application circuit

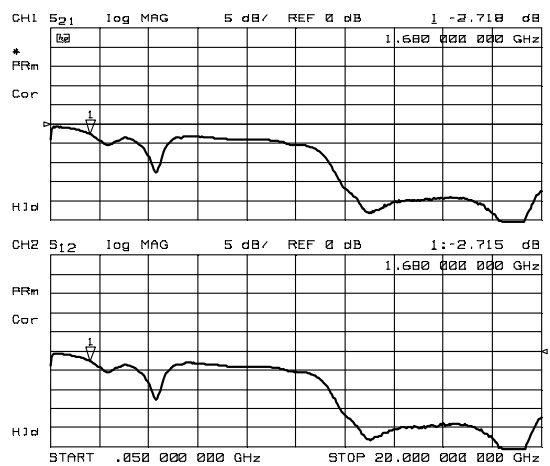
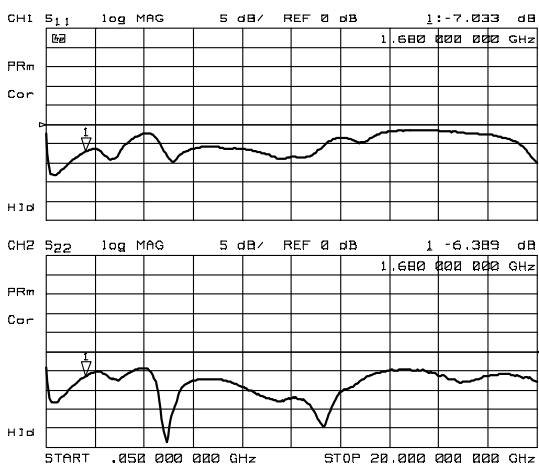
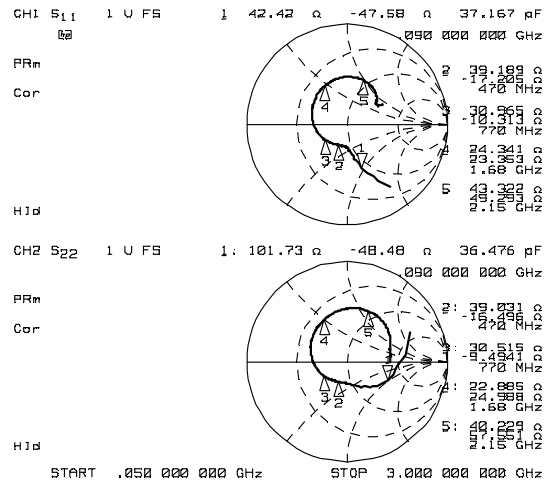
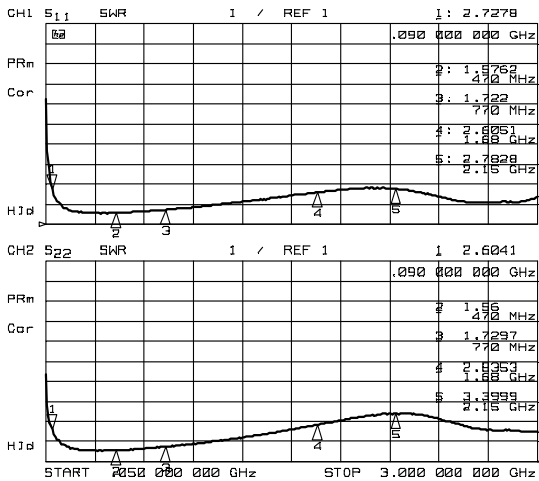
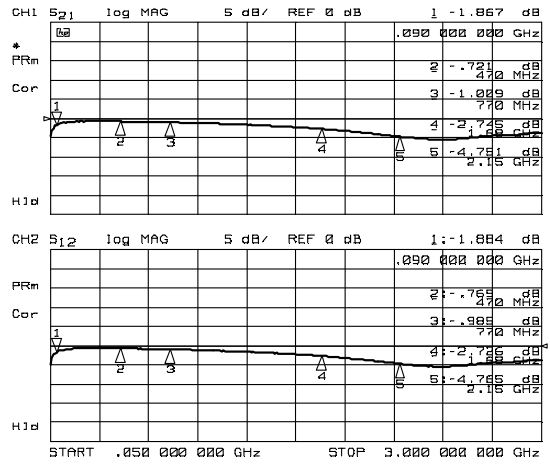
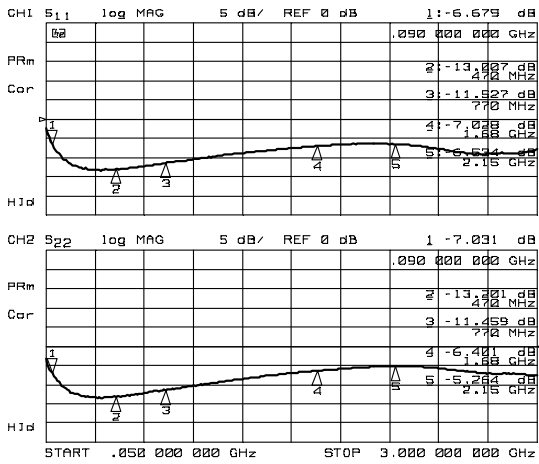

NJG1145UA2

APPLICATION CIRCUIT

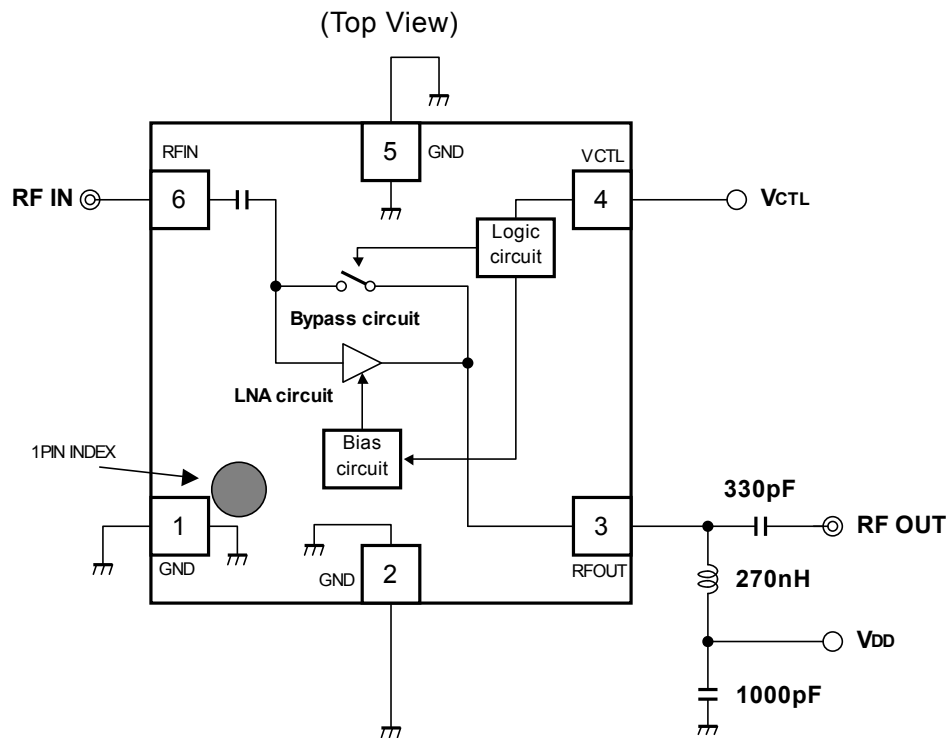

TEST PCB LAYOUT

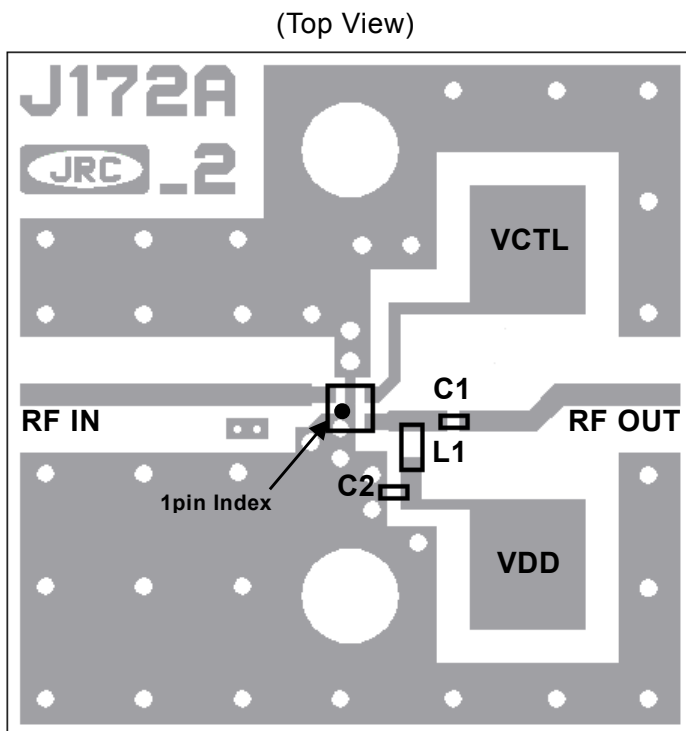

PARTS LIST

Parts ID.	Manufacturer
L1	TAIYO-YUDEN HK1005 Series
C1, C2	MURATA GRM03 Series

PCB (FR-4):

t=0.2mm

MICROSTRIP LINE WIDTH

=0.40mm ($Z_0=50$ ohm)

PCB SIZE=14.0mm x 14.0mm

PRECAUTIONS

- C1 is a coupling and DC blocking capacitor at the output, and C2 is a bypass capacitor.
- L1 is an RF choke. (DC feed inductor)
- In order not to couple with terminal RFIN and RFOUT, please layout ground pattern under the IC.
- All external parts are placed as close as possible to the IC.

MEASUREMENT BLOCK DIAGRAM

Measuring instruments

NF Analyzer : Agilent 8973A
 Noise Source : Agilent 346A

Setting the NF analyzer

Measurement mode form

Device under test : Amplifier
 System downconverter : off

Mode setup form

Sideband : LSB
 Averages : 16
 Average mode : Point
 Bandwidth : 4MHz
 Loss comp : off
 Tcold : setting the temperature of noise source (300.0K)

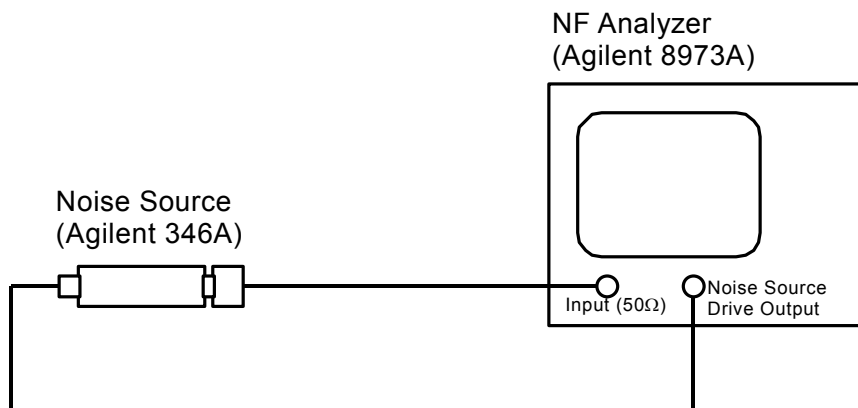

* Noise source and NF analyzer are connected directly.

Calibration Setup

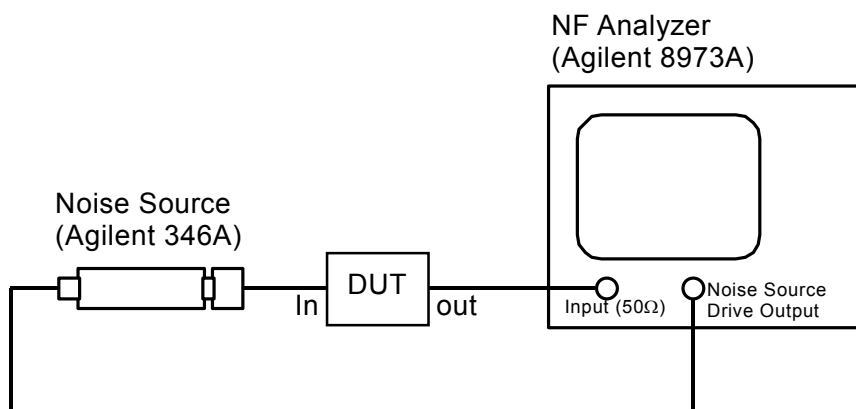

* Noise source and DUT, DUT and NF analyzer are connected directly.

Measurement Setup

NJG1145UA2

PACKAGE OUTLINE (EPFFP6-A2)

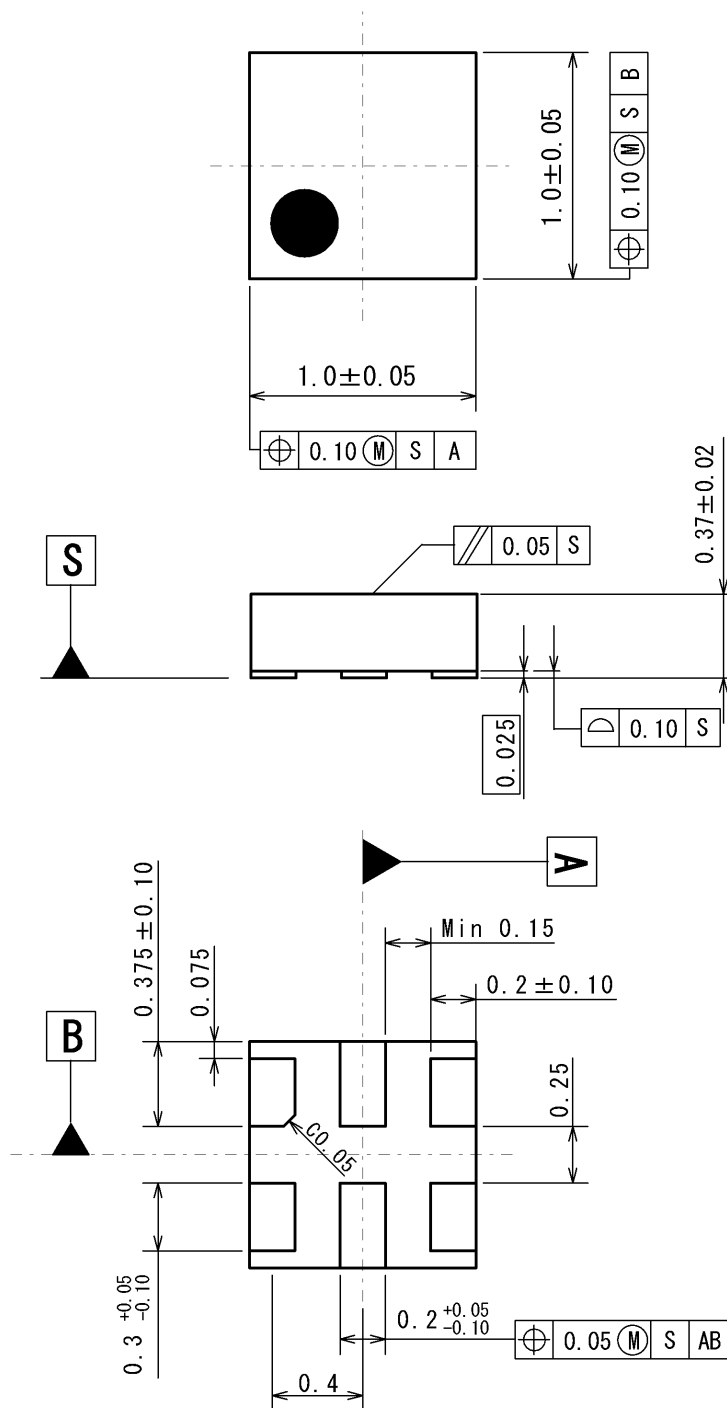

Unit	:mm
Substrate	:FR-4
Terminal Treat	:Au
Molding Material	:Epoxy Resin
Weight	:0.855mg

Cautions on using this product

- This product contains Gallium-Arsenide (GaAs) which is a harmful material.
- Do NOT eat or put into mouth.
 - Do NOT dispose in fire or break up this product.
 - Do NOT chemically make gas or powder with this product.
 - To waste this product, please obey the relating law of your country.

[CAUTION]

The specifications on this databook are only given for information, without any guarantee as regards either mistakes or omissions. The application circuits in this databook are described only to show representative usages of the product and not intended for the guarantee or permission of any right including the industrial rights.

This product may be damaged with electric static discharge (ESD) or spike voltage. Please handle with care to avoid these damages.