

GD401SD

SURFACE MOUNT, SCHOTTKY BARRIER DIODE VOLTAGE 30V, CURRENT 0.2A

Description

The GD401SD is high frequency rectification for switching power supply.

Package Dimensions

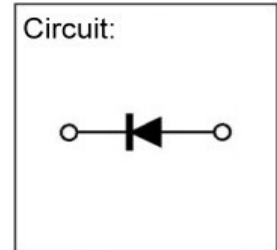
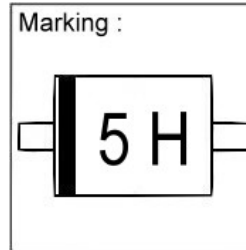
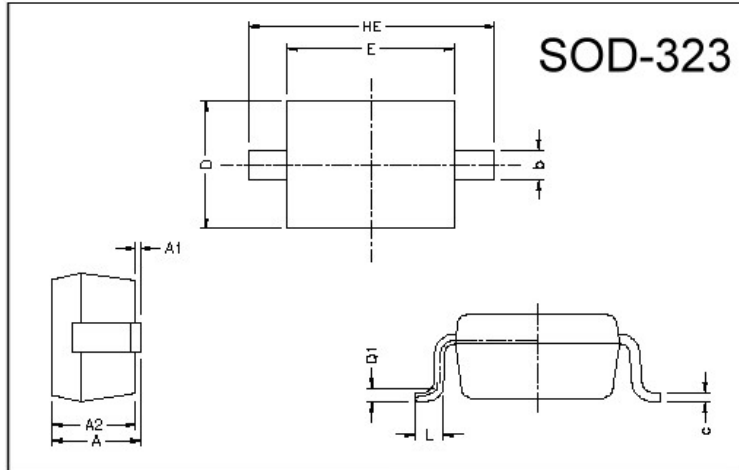

REF.	Millimeter		REF.	Millimeter	
	Min.	Max.		Min.	Max.
A	0.85	1.05			
A1	0	0.10	L	0.20	0.40
A2	0.80	1.00	b	0.25	0.40
D	1.15	1.45	c	0.10	0.18
E	1.60	1.80			
HE	2.30	2.70	Q1	0.15 BSC.	

Absolute Maximum Ratings at TA = 25°C

Parameter	Symbol	Ratings	Unit
Junction Temperature	T _j	+125	°C
Storage Temperature	T _{stg}	-55 ~ +125	°C
Maximum Recurrent Peak Reverse Voltage	V _{RRM}	30	V
Maximum RMS Voltage	V _{RMS}	21	V
Maximum DC Blocking Voltage	V _{DC}	30	V
Peak Forward Surge Current at 8.3mSec single half sine-wave	I _{FSM}	3.0	A
Typical Junction Capacitance between Terminal (Note 1)	C _J	40	pF
Maximum Average Forward Rectified Current	I _o	0.2	A
Total Power Dissipation	PD	225	mW

Electrical Characteristics (at TA = 25°C unless otherwise noted)

Parameter	Symbol	Min.	Typ.	Max.	Unit	Test Conditions
Reverse Breakdown Voltage	V _{(BR)R}	30	-	-	V	I _R =100μA
Maximum Instantaneous Forward Voltage	V _F	-	-	500	mV	I _F =200mA
Maximum Average Reverse Current	I _R	-	-	50	μA	VR1=10V
		-	-	100	μA	VR2=30V

Notes: 1. Measured at 1.0 MHz and 0 reverse bias voltage.

2. ESD sensitive product handling required.

Characteristics Curve

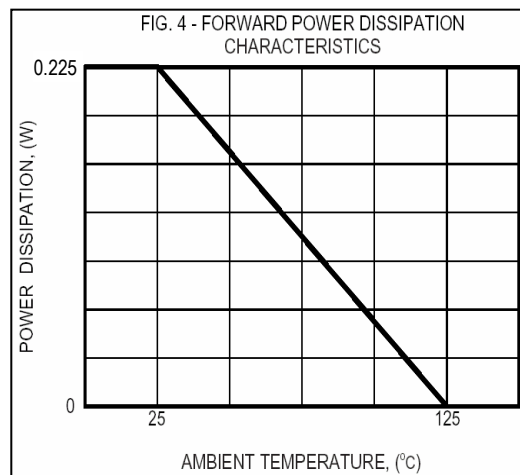
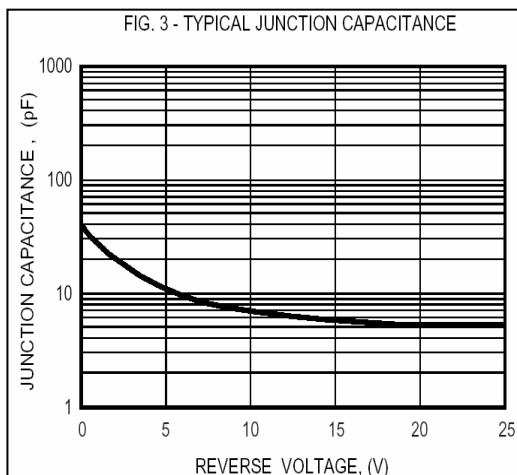
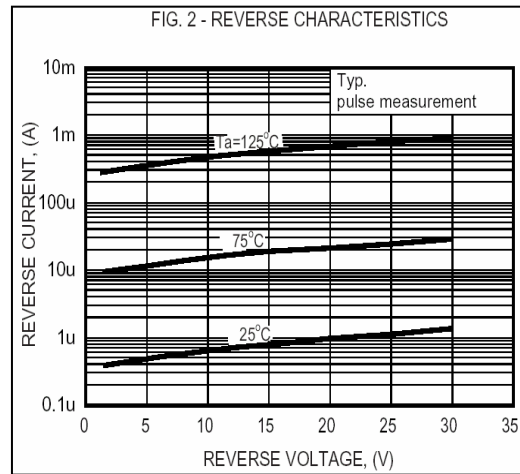
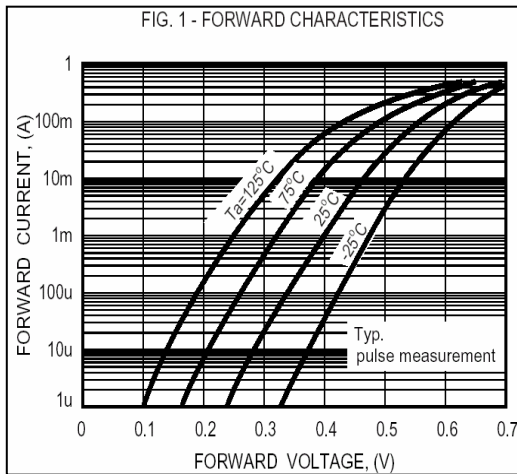

Important Notice:

- All rights are reserved. Reproduction in whole or in part is prohibited without the prior written approval of GTM.
- GTM reserves the right to make changes to its products without notice.
- GTM semiconductor products are not warranted to be suitable for use in life-support Applications, or systems.
- GTM assumes no liability for any consequence of customer product design, infringement of patents, or application assistance.

Head Office And Factory:

- **Taiwan:** No. 17-1 Tatung Rd. Fu Kou Hsin-Chu Industrial Park, Hsin-Chu, Taiwan, R. O. C.
- TEL : 886-3-597-7061 FAX : 886-3-597-9220, 597-0785
- **China:** (201203) No.255, Jang-Jiang Tsai-Lueng RD. , Pu-Dung-Hsin District, Shang-Hai City, China
- TEL : 86-21-5895-7671 ~ 4 FAX : 86-21-38950165