

# Drivers for Large LCD Panels

## 6bit RSDS™

### Source Driver



BU95303

No.10043EAT02

#### ●Description

ROHMLCD drivers for large panels are display drivers optimized for large LCDs in a variety of applications, including desktop PCs, laptops, and TVs. The broad lineup is offered in low amplitude differential transmission interface type (RSDS™) featuring low EMI, 6bit gradation precision, and different output configurations (432 and up) for wide compatibility.

#### ●Features

- 1) 384/414/420/432 output channels
- 2) 6bit 9pair RSDS™ inputs
- 3) Dot & n-line inversion available
- 4) Built-in 2ch repair amplifiers
- 5)  $\gamma$  correction is possible
- 6) Built-in input data reversing function (INV)
- 7) Output voltage range :  $AV_{SS}+0.1V \sim AV_{DD}-0.1V$
- 8) High speed data transfer:  $f_{CLK(MAX)}=85MHz$
- 9) Logic power supply voltage ( $DV_{DD}$ ) : 2.7 ~ 3.6V
- 10) Driver power supply voltage ( $AV_{DD}$ ) : 10.0 ~ 13.5V
- 11) Package: COF35

#### ●Applications

TFT LCD Panels

#### ●Line up matrix

	BU95101	BU95303	BU95306	BU95408
Number of outputs	384	384 / 414 / 420 / 432	600 / 618 / 630 / 642	684 / 690 / 702 / 720

●Absolute maximum ratings

Parameter	Symbol	Ratings	Unit
Logic power supply voltage	DV <sub>DD</sub>	-0.3 ~ +4.5	V
Driver power supply voltage	AV <sub>DD</sub>	-0.3 ~ +14.0	V
Logic input voltage	V <sub>I1</sub>	-0.3 ~ DV <sub>DD</sub> +0.3	V
Logic output voltage	V <sub>O1</sub>	-0.3 ~ DV <sub>DD</sub> +0.3	V
Driver input voltage	V <sub>I2</sub>	-0.3 ~ AV <sub>DD</sub> +0.3	V
Driver output voltage	V <sub>O2</sub>	-0.3 ~ AV <sub>DD</sub> +0.3	V
Storage temperature range	T <sub>stg</sub>	-55 ~ +125	°C

●Recommended operating range

Parameter	Symbol	Ratings	Unit
Logic power supply voltage	DV <sub>DD</sub>	+2.7 ~ +3.6	V
Driver power supply voltage	AV <sub>DD</sub>	+10.0 ~ +13.5	V
γ-correction reference voltage	V <sub>0</sub> ~ V <sub>6</sub>	0.5 AV <sub>DD</sub> ~ AV <sub>DD</sub> -0.1	V
	V <sub>7</sub> ~ V <sub>13</sub>	0.1 ~ 0.5 AV <sub>DD</sub>	V
Driver output voltage	V <sub>O</sub>	0.1 ~ AV <sub>DD</sub> -0.1	V
Output load capacitance	C <sub>L</sub>	80	pF
Maximum clock frequency	f <sub>CLK(MAX)</sub>	85	MHz
Operating temperature range	T <sub>opr</sub>	-10 ~ +85	°C

\* AV<sub>SS</sub>=DV<sub>SS</sub>=0V

### ●Electrical characteristics (DC)

(Unless otherwise noted, Ta=-10 ~ +85°C, DV<sub>DD</sub>=2.7 ~ 3.6V, AV<sub>DD</sub>=10.0 ~ 13.5V, DV<sub>SS</sub>=AV<sub>SS</sub>=0V)

Parameter	Symbol	Limits			Unit	Conditions	
		Min.	Typ.	Max.			
Logic Part							
Logic supply current	I <sub>DDL</sub>	-	-	8	mA	DV <sub>DD</sub> =3.3V, Data=00h-3Fh(dot), fclk=65MHz, fstb=50kHz, 1Line-inverison	
Input "H" voltage	V <sub>1H</sub>	0.7DV <sub>DD</sub>	-	DV <sub>DD</sub>	V	R/L,SFTR,INV,SFTL,POL,STB,SEL0,SEL1,LPC0,LPC1	
Input "L" voltage	V <sub>1L</sub>	0	-	0.3DV <sub>DD</sub>	V		
Input "H" current	I <sub>1H1</sub>	-	-	+1	μA	V <sub>IN</sub> =DV <sub>DD</sub> Dxx, SFTR, POL, INV, SFTL,CLK,STB,R/L	
Input "L" current	I <sub>1L1</sub>	-1	-	-	μA	V <sub>IN</sub> =DV <sub>SS</sub>	
Input "H" current 2	I <sub>1H2</sub>	-	20	40	μA	V <sub>IN</sub> =DV <sub>DD</sub> , DV <sub>DD</sub> =3.3V	
Input "L" current 2	I <sub>1L2</sub>	-3	-	+3	μA	V <sub>IN</sub> =DV <sub>SS</sub> SEL0,SEL1,LPC1,LPC0,Built-in Pull down R	
Input "H" current 3	I <sub>1H3</sub>	-3	-	+3	μA	V <sub>IN</sub> =DV <sub>DD</sub> Built-in Pull up R	
Input "L" current 3	I <sub>1L3</sub>	-40	-20	-	μA	V <sub>IN</sub> =DV <sub>SS</sub> , DV <sub>DD</sub> =3.3V	
Output "H" voltage	V <sub>OH</sub>	DV <sub>DD</sub> -0.5	-	-	V	I <sub>OH</sub> =-1.0mA	
Output "L" voltage	V <sub>OL</sub>	-	-	0.5	V	I <sub>OL</sub> =1.0mA	
Driver part							
Driver supply current	I <sub>DDA</sub>	-	-	12	mA	fCLK=85MHz,DATA=00h,fSTB=56kHz,fPOL=28kHz, No Load AVDD=12V,V0=11.9V, V13=0.1V	
γ correction resistance	R <sub>γUP</sub>	0.7Typ	11.88	1.3Typ	kΩ	V0 ~ V6	
	R <sub>γLOW</sub>	0.7Typ	11.88	1.3Typ	kΩ	V7 ~ V13	
Output voltage deviation	V <sub>OD1</sub> <sup>*1</sup>	-	±25	±40	mV	AV <sub>DD</sub> =12V, Yout=0.1V ~ 1.5V, Yout=10.5V ~ 11.9V	
		-	±15	±25	mV	AV <sub>DD</sub> =12V, Yout=1.5V ~ 10.5V	
Output swing voltage Deviation	V <sub>RMS</sub> <sup>*2</sup>	-	±25	±40	mV	AV <sub>DD</sub> =12V, Yout=0.1V ~ 1.5V, Yout=10.5V ~ 11.9V	
		-	±5	±10	mV	AV <sub>DD</sub> =12V, Vout=1.5V ~ 10.5V	
Output voltage deviation 2 (between chips)	V <sub>OD2</sub> <sup>*3</sup>	-	-	±7.5	mV	AV <sub>DD</sub> =12V, Data=32-gray	
Repair input voltage	V <sub>1NB</sub>	0.1	-	AV <sub>DD</sub> -0.1	V	IREP1,2	
Repair input "H" current	I <sub>1BH</sub>	-1	-	+1	μA		V <sub>IN</sub> =AV <sub>DD</sub> =12 V
Repair input "L" current	I <sub>1BL</sub>	-1	-	+1	μA		V <sub>IN</sub> =AV <sub>SS</sub>
Driver output "H" current	I <sub>VOHY</sub>	-	-	-0.4	mA	Y1 ~ Y432, AV <sub>DD</sub> =12V, Vx=6 V, Yout=11V	
	I <sub>VOHR</sub>	-	-	-0.8	mA	OREP1,2, AV <sub>DD</sub> =12V, Vx=6 V, Yout=11V	
Driver output"L" current	I <sub>VOLY</sub>	0.4	-	-	mA	Y1 ~ Y432, AV <sub>DD</sub> =12V, Vx=6 V, Yout=1V	
	I <sub>VOLR</sub>	0.8	-	-	mA	OREP1,2, AV <sub>DD</sub> =12V, Vx=6 V, Yout=1V	
RSDS™ input part							
RSDS™ input "H" voltage	V <sub>IHRSDS</sub>	100	200	-	mV	VCM <sub>RSDS</sub> =+1.2V <sup>*4</sup>	
RSDS™ input "L" voltage	V <sub>ILRSDS</sub>	-	-200	-100	mV		
RSDS™ common input voltage	V <sub>CMRSDS</sub>	0.4	-	DV <sub>DD</sub> -1.2	V	V <sub>DIFF</sub> =200mV <sup>*5</sup>	

\*1 V<sub>OD1</sub>=measured output voltage - averaged output voltage of all outputs

\*2 V<sub>RMS</sub>=measured output swing voltage - averaged output swing voltage of all outputs

\*3 V<sub>OD2</sub>=averaged output voltage - target value

\*4 VCM<sub>RSDS</sub> = (VCLK<sub>P</sub>+VCLK<sub>N</sub>)/2 or (VD<sub>XXP</sub>+VD<sub>XXN</sub>)/2

\*5 V<sub>DIFF</sub> = VCLK<sub>P</sub>- VCLK<sub>N</sub> or VD<sub>XXP</sub>-VD<sub>XXN</sub>

●Electrical characteristics (AC)

(Unless otherwise noted, Ta=-10 ~ +85°C, DV<sub>DD</sub>=2.7 ~ 3.6V, AV<sub>DD</sub>=10.0 ~ 13.5V, DV<sub>SS</sub>=AV<sub>SS</sub>=0V)

Parameter	Symbol	Limits			Unit	Conditions
		Min.	Typ.	Max.		
Clock pulse width	tw	1/85MHz	-	-	ns	
Clock pulse "H" period	th	5	-	-	ns	
Clock pulse "L" period	tl	5	-	-	ns	
Data setup time	tsu1	2	-	-	ns	
Data hold time	thd1	0	-	-	ns	
Start pulse setup time	tsu2	1	-	-	ns	
Start pulse hold time	thd2	2	-	-	ns	
Start pulse width	t <sub>WSFT</sub>	1	-	2	CLK period	
Carry output delay time	tdc	-	-	11	ns	C <sub>L</sub> =15pF
STB pulse width	t <sub>WSTB</sub>	1	-	-	CLK period	
Final data timing	t <sub>LDT</sub>	1	-	-	CLK period	
Time between STB↑and start pulse↑	t <sub>STB-SFT</sub>	6	-	-	CLK period	
Time between STB↑and CLK↓	t <sub>STB-CLK</sub>	4	-	-	ns	
POL/STB setup time	tsp	14	-	-	ns	
Output delay time	tdout	-	-	3	μs	LPC:normal *1*3
		-	-	5	μs	LPC:normal *2*3
		-	-	5	μs	LPC:low power *1*3
		-	-	7	μs	LPC:low power *2*3

\*1 The value is specified when the drive voltage value reaches the target output voltage level of 90%.  
 \*2 The value is specified when the drive voltage value reaches the target output voltage level of 6-bit accuracy.  
 \*3 Output load condition:  
 R1=R2=R3=10kΩ, C1=C2=C3=20pF

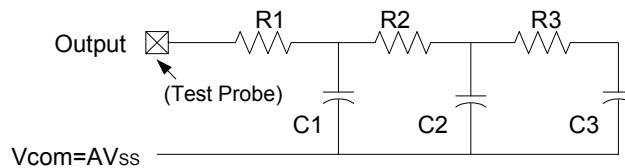

●Block diagram

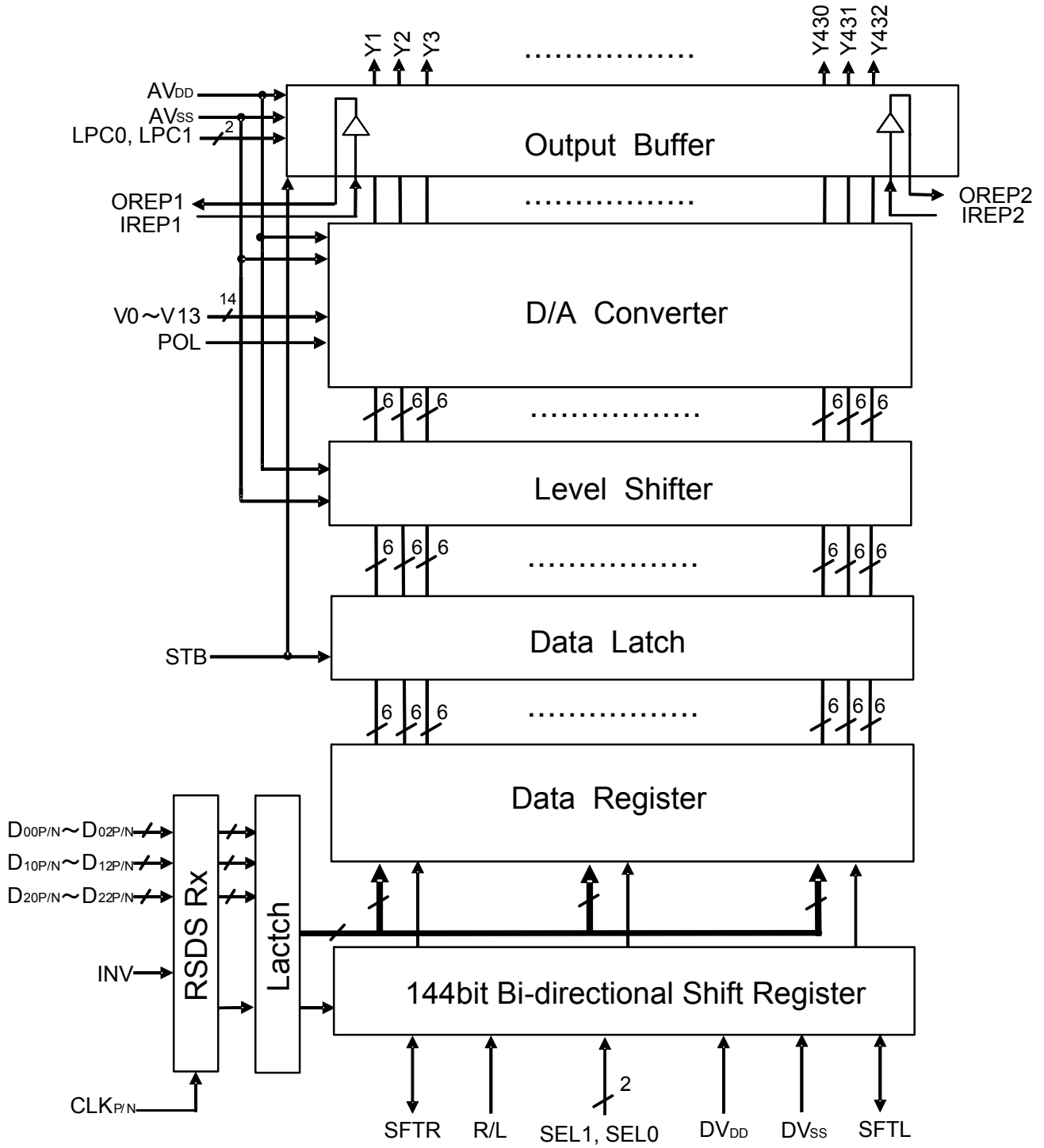

Fig.1 Block diagram

●Pin configuration

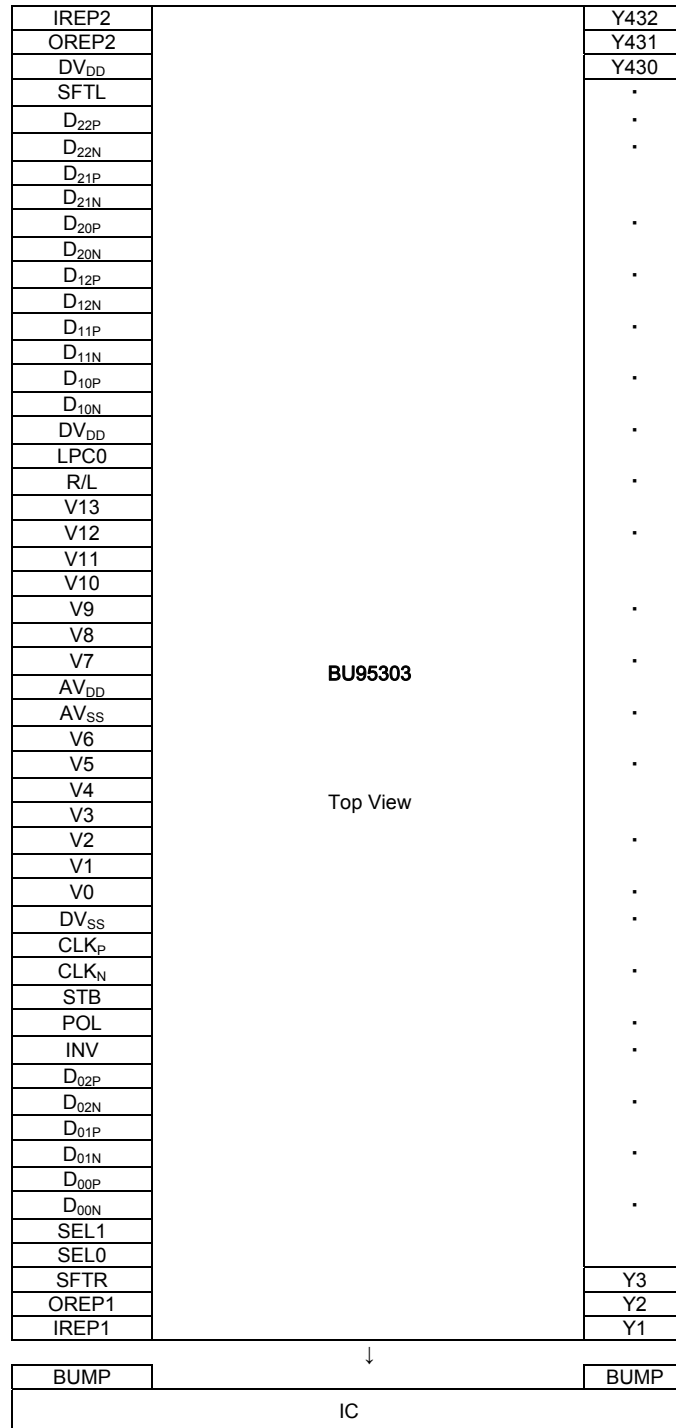



Fig.2 Pin configuration (Top View)

## ● Pin Descriptions

Pin Name	In/Out	Active	Descriptions																				
D <sub>00P/N</sub> ~ D <sub>02P/N</sub> D <sub>10P/N</sub> ~ D <sub>12P/N</sub> D <sub>20P/N</sub> ~ D <sub>22P/N</sub>	In	Differential	RSDS™ input terminals of display data The 3-bit differential input pairs generate the internal 6-bit data through the comparison between D <sub>XXP</sub> and D <sub>XXN</sub> .																				
CLK <sub>P/N</sub>	In	Differential	The RSDS™ clock input pair generate the internal shift clock through the comparison between CLK <sub>P</sub> and CLK <sub>N</sub> .																				
Y1 ~ Y432	Out	-	Driver outputs for D/A converted 64 gray scale analog voltage.																				
R/L	In	-	The shift direction of internal shift register is controlled by this pin as shown below. R/L=H : Right shift SFTR→Y1→Y432→SFTL R/L=L : Left shift SFTL→Y432→Y1→SFTR																				
SEL0 SEL1	In	-	The output channel number is controlled by this pin as shown below. <table border="1" style="margin-left: 20px;"> <thead> <tr> <th>SEL1</th> <th>SEL0</th> <th>Number of effective output terminal</th> <th>Invalid output terminal</th> </tr> </thead> <tbody> <tr> <td>H</td> <td>H</td> <td>384</td> <td>Y193 ~ Y240 become Hi-Z</td> </tr> <tr> <td>H</td> <td>L</td> <td>414</td> <td>Y208 ~ Y225 become Hi-Z</td> </tr> <tr> <td>L</td> <td>H</td> <td>420</td> <td>Y211 ~ Y222 become Hi-Z</td> </tr> <tr> <td>L</td> <td>L</td> <td>432(default)</td> <td>-</td> </tr> </tbody> </table> <p>This pin is pulled down to the DV<sub>SS</sub> inside the IC.</p>	SEL1	SEL0	Number of effective output terminal	Invalid output terminal	H	H	384	Y193 ~ Y240 become Hi-Z	H	L	414	Y208 ~ Y225 become Hi-Z	L	H	420	Y211 ~ Y222 become Hi-Z	L	L	432(default)	-
SEL1	SEL0	Number of effective output terminal	Invalid output terminal																				
H	H	384	Y193 ~ Y240 become Hi-Z																				
H	L	414	Y208 ~ Y225 become Hi-Z																				
L	H	420	Y211 ~ Y222 become Hi-Z																				
L	L	432(default)	-																				
LPC0 LPC1	In	H	Low power control pin <table border="1" style="margin-left: 20px;"> <thead> <tr> <th>LPC1</th> <th>LPC0</th> <th>power condition</th> </tr> </thead> <tbody> <tr> <td>H</td> <td>H</td> <td>Strong power</td> </tr> <tr> <td>H</td> <td>L</td> <td>Normal power</td> </tr> <tr> <td>L</td> <td>H</td> <td>Ultra-low power</td> </tr> <tr> <td>L</td> <td>L</td> <td>Low power(default).</td> </tr> </tbody> </table> <p>This pin is pulled down to the DV<sub>SS</sub> inside the IC.</p>	LPC1	LPC0	power condition	H	H	Strong power	H	L	Normal power	L	H	Ultra-low power	L	L	Low power(default).					
LPC1	LPC0	power condition																					
H	H	Strong power																					
H	L	Normal power																					
L	H	Ultra-low power																					
L	L	Low power(default).																					
SFTR	In/Out	H	SFTR=H: Right shift start pulse input terminal in cascade connection. SFTR=L: Carry output terminal in cascade connection.																				
SFTL	In/Out	H	SFTL=H: Carry output terminal in cascade connection. SFTL=L: Left shift start pulse input terminal in cascade connection.																				
STB	In		The data in the data register are transferred to the data latch at the rising edge of STB, then the gray scale voltages are output from the buffer at the falling edge of STB.																				
INV	In	H	Terminal to specify inverting or non-inverting of display data INV:H : Input data are inverted in the IC. INV:L : Input data are not inverted.																				
V0 ~ V13	In	-	Input for the $\gamma$ -correction reference voltage The following external reference voltages are input.																				
POL	In	-	At the rising edge of STB, the state of POL are transferred to the driver. POL=H : The reference voltage for odd number outputs are V0 to V6 and those for even number outputs are V7 to V13. POL=L : The reference voltage for odd number outputs are V7 to V13 and those for even number outputs are V0 to V6																				
IREF1,2	In	-	Repair amplifier input																				
OREP1,2	Out	-	Repair amplifier output																				
AV <sub>DD</sub>	In	-	Power supply for driver block																				
AV <sub>SS</sub>	In	-	Ground for AV <sub>DD</sub>																				
DV <sub>DD</sub>	In	-	Power supply for digital block																				
DV <sub>SS</sub>	In	-	Ground for DV <sub>DD</sub>																				

●Relationship between Input Data and Output Terminals

R/L=H (Right Shift)

	First			→	Last		
Data	D <sub>00P</sub> ~ D <sub>02N</sub>	D <sub>10P</sub> ~ D <sub>12N</sub>	D <sub>20P</sub> ~ D <sub>22N</sub>	...	D <sub>00P</sub> ~ D <sub>02N</sub>	D <sub>10P</sub> ~ D <sub>12N</sub>	D <sub>20P</sub> ~ D <sub>22N</sub>
Output	Y1	Y2	Y3	...	Y430	Y431	Y432

R/L=L (Left Shift)

	First			→	Last		
Data	D <sub>00P</sub> ~ D <sub>02N</sub>	D <sub>10P</sub> ~ D <sub>12N</sub>	D <sub>20P</sub> ~ D <sub>22N</sub>	...	D <sub>00P</sub> ~ D <sub>02N</sub>	D <sub>10P</sub> ~ D <sub>12N</sub>	D <sub>20P</sub> ~ D <sub>22N</sub>
Output	Y430	Y431	Y432	...	Y1	Y2	Y3

●Relationship between R/L , SFTR , SFTL and Output Direction

R/L pin controls the shift direction of the internal shift resistor as shown below.

Terminal	Right Shift Mode	Left Shift Mode
R/L	“H”	“L”
SFTR	Input	Output
SFTL	Output	Input
Output direction	Y1,Y2,Y3→Y432,Y431,Y430	Y432,Y431,Y130→Y3,Y2,Y1

●Relationship between POL and Output Polarity

POL	“H”	“L”
Y1	+ <sup>*1</sup>	- <sup>*1</sup>
Y2	-	+
Y3	+	-
Y4	-	+
Y5	+	-
Y6	-	+
⋮	⋮	⋮
Y427	+	-
Y428	-	+
Y429	+	-
Y430	-	+
Y431	+	-
Y432	-	+

\*1 +: The reference voltage are V0 ~ V6  
 -: The reference voltage are V7 ~ V13



●Relationship between Input Data and Output Voltage

The LCD driver output voltages are determined by the input data and 14  $\gamma$ -corrected power supply.

$$0.1V \leq V_{13} \leq V_{12} \leq V_{11} \leq V_{10} \leq V_9 \leq V_8 \leq V_7 \leq 0.5AV_{DD}$$

$$0.5 AV_{DD} \leq V_6 \leq V_5 \leq V_4 \leq V_3 \leq V_2 \leq V_1 \leq V_0 \leq AV_{DD} - 0.1V$$

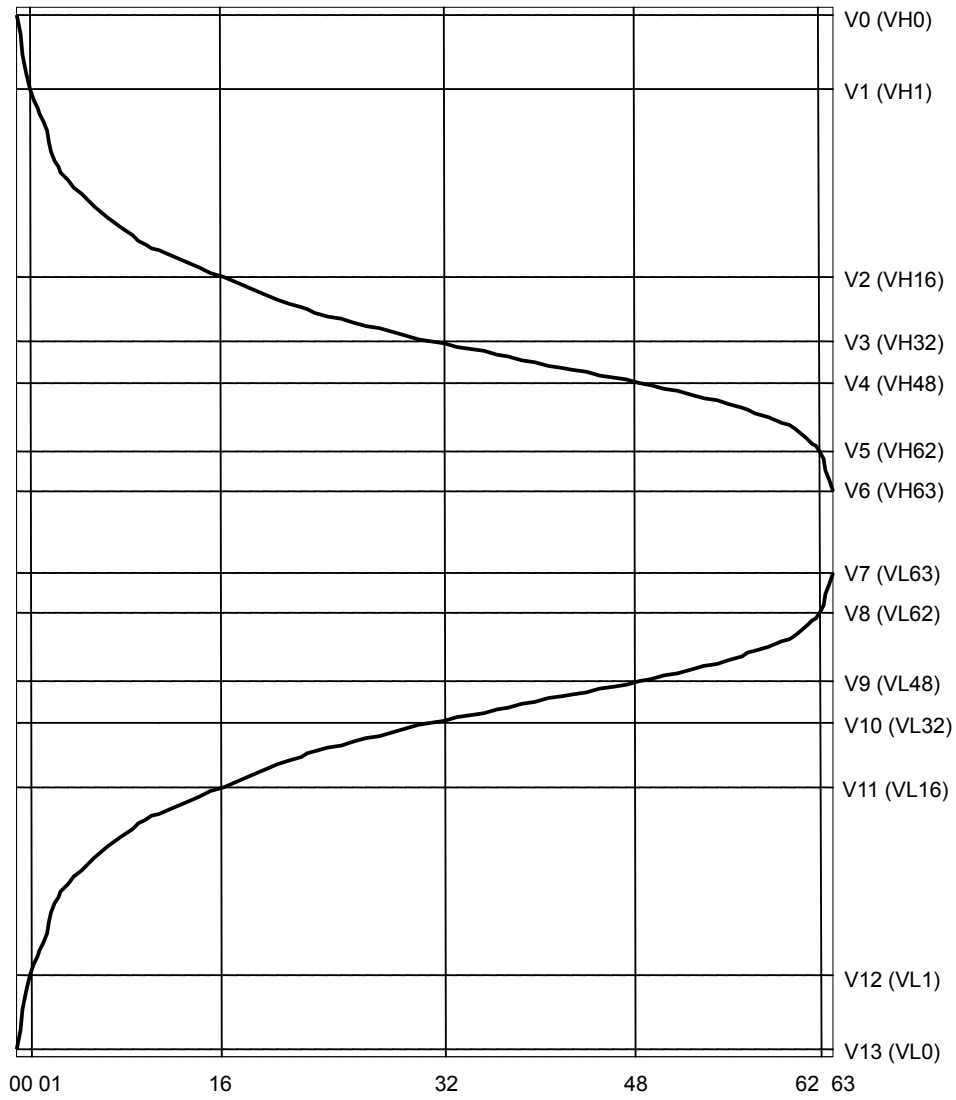

Fig.3 Input data -  $\gamma$  correction curve

●  $\gamma$  correction Power Supply Circuit

14 external  $\gamma$ -corrected power supply is connected to ladder resistors inside IC.

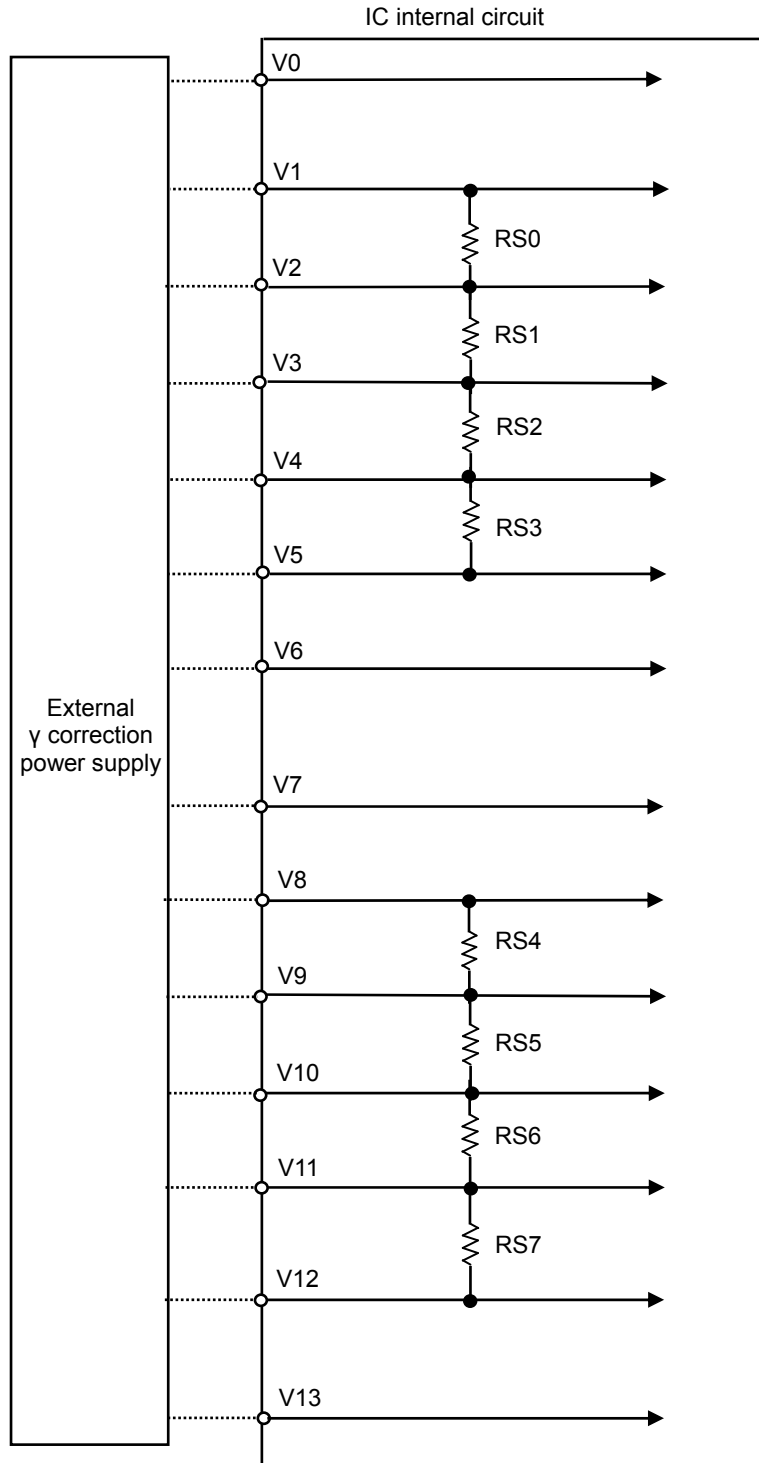

Fig.4  $\gamma$  correction power supply circuit



●Timing chart

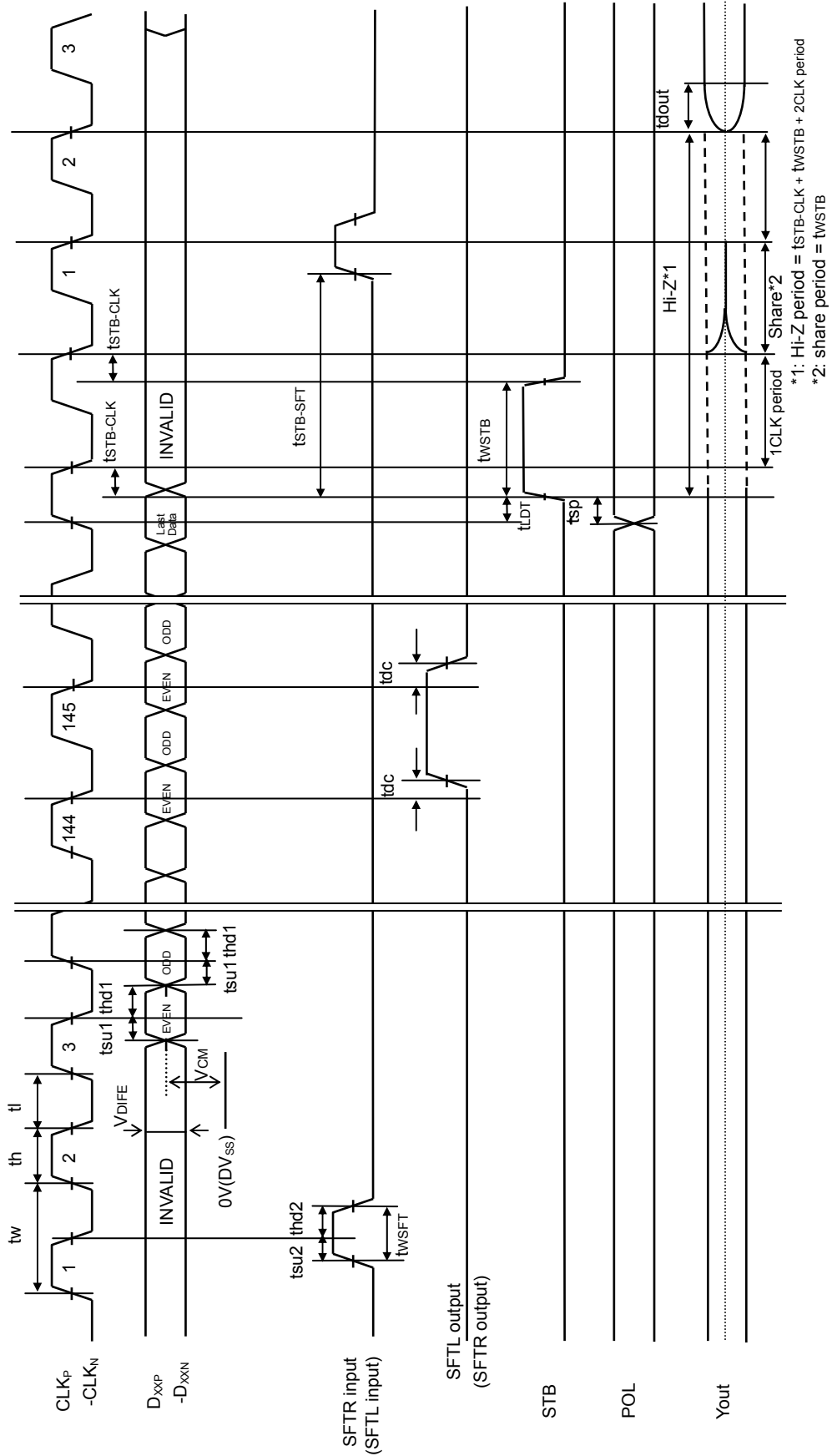
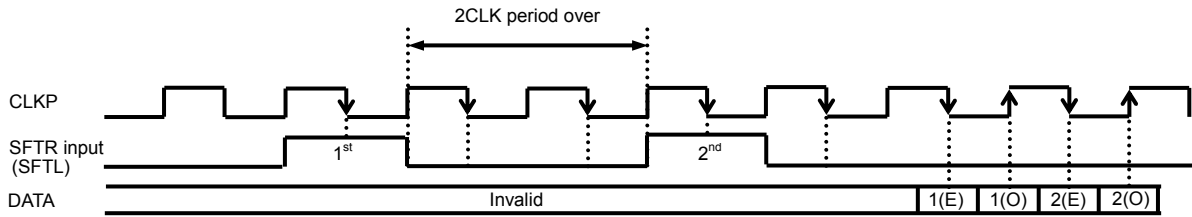

Fig.6 Timing chart

### ●Start pulse timing



When the start pulse (SFTR, SFTL) is input two times, the data is sampled based on the second start pulse.

### ●Power Supply Sequence

Maintain the following power supply order to prevent the device from being destroyed.

Turn on power order :  $DV_{DD}$  → Input signal →  $AV_{DD}$ , V0 ~ V13

Turn off power order :  $AV_{DD}$ , V0 ~ V13 → Input signal →  $DV_{DD}$

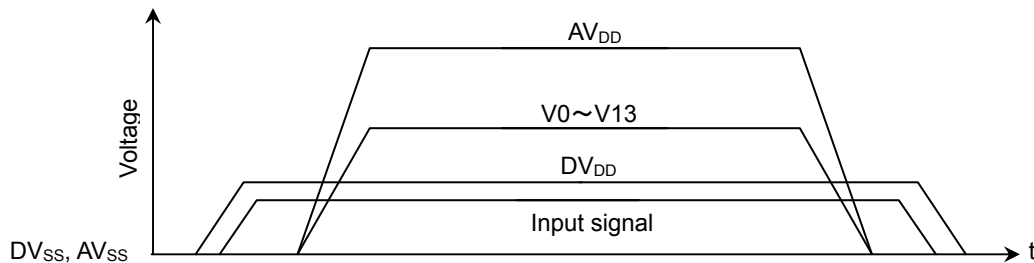

### ●Notes for use

1. When power is first supplied to the CMOS IC, it is possible that the internal logic may be unstable and rush current may flow instantaneously.  
Therefore, give special consideration to power coupling capacitance, power wiring, width of GND wiring, and routing of connections.
2. For ICs with more than one power supply, it is possible that rush current may flow instantaneously due to the internal powering sequence and delays.  
Therefore, give special consideration to power coupling capacitance, power wiring, width of GND wiring, and routing of wiring.

●Ordering part number

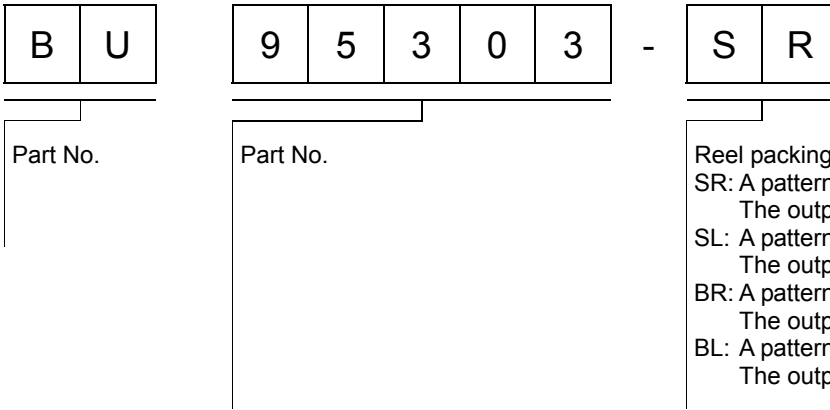

COF35

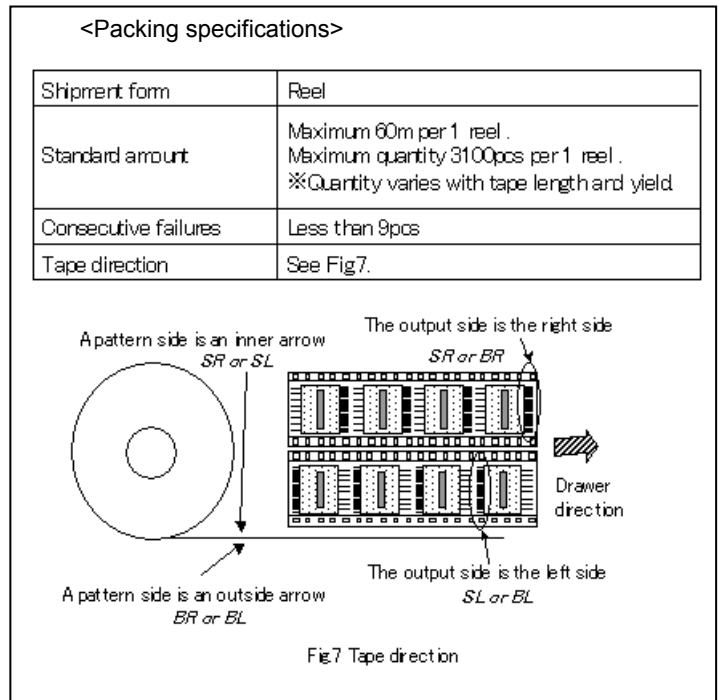
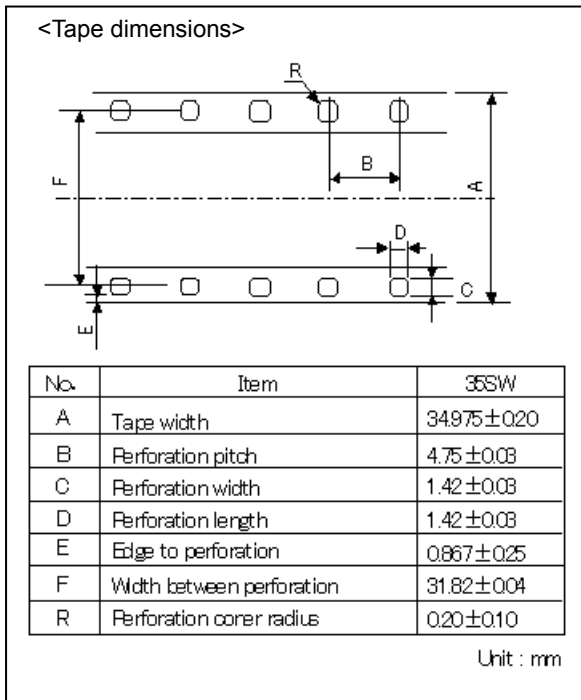

## Notes

No copying or reproduction of this document, in part or in whole, is permitted without the consent of ROHM Co.,Ltd.

The content specified herein is subject to change for improvement without notice.

The content specified herein is for the purpose of introducing ROHM's products (hereinafter "Products"). If you wish to use any such Product, please be sure to refer to the specifications, which can be obtained from ROHM upon request.

Examples of application circuits, circuit constants and any other information contained herein illustrate the standard usage and operations of the Products. The peripheral conditions must be taken into account when designing circuits for mass production.

Great care was taken in ensuring the accuracy of the information specified in this document. However, should you incur any damage arising from any inaccuracy or misprint of such information, ROHM shall bear no responsibility for such damage.

The technical information specified herein is intended only to show the typical functions of and examples of application circuits for the Products. ROHM does not grant you, explicitly or implicitly, any license to use or exercise intellectual property or other rights held by ROHM and other parties. ROHM shall bear no responsibility whatsoever for any dispute arising from the use of such technical information.

The Products specified in this document are intended to be used with general-use electronic equipment or devices (such as audio visual equipment, office-automation equipment, communication devices, electronic appliances and amusement devices).

The Products specified in this document are not designed to be radiation tolerant.

While ROHM always makes efforts to enhance the quality and reliability of its Products, a Product may fail or malfunction for a variety of reasons.

Please be sure to implement in your equipment using the Products safety measures to guard against the possibility of physical injury, fire or any other damage caused in the event of the failure of any Product, such as derating, redundancy, fire control and fail-safe designs. ROHM shall bear no responsibility whatsoever for your use of any Product outside of the prescribed scope or not in accordance with the instruction manual.

The Products are not designed or manufactured to be used with any equipment, device or system which requires an extremely high level of reliability the failure or malfunction of which may result in a direct threat to human life or create a risk of human injury (such as a medical instrument, transportation equipment, aerospace machinery, nuclear-reactor controller, fuel-controller or other safety device). ROHM shall bear no responsibility in any way for use of any of the Products for the above special purposes. If a Product is intended to be used for any such special purpose, please contact a ROHM sales representative before purchasing.

If you intend to export or ship overseas any Product or technology specified herein that may be controlled under the Foreign Exchange and the Foreign Trade Law, you will be required to obtain a license or permit under the Law.



Thank you for your accessing to ROHM product informations.  
More detail product informations and catalogs are available, please contact us.

## ROHM Customer Support System

<http://www.rohm.com/contact/>